

4TECT

ООО «4TECT»

Телефон: +7 (499) 685-4444

info@4test.ru

www.4test.ru

Rosenberger

Communication Products

RF Coaxial Connectors, Adaptors & Accessories



Rosenberger Codes

Rosenberger Number Code

19	S	1	01-	4	0M	L5
						Plating Code
						01-Z9 Cable Group (see last page)
						00 Blank
						0M Surface Mount Device
						0P Press-fit Version
						0 Clamp Version, Accessories
						1 Crimp Version
						2 Solder Version, Solder Pot
						3 Solder Crimp Version
						4 PCB Mounting
						5 Solid Center Contact, Coax Transition
						6 Stripline
						7 Microstrip
						8 Crimp Version - Pigtail
						K Adaptors female (2nd end)
						S Adaptors male (2nd end)
						Successive Number
						1 Straight Connector
						2 Right Angle Connector
						3 T-or Y-Adapter
						4 Panel Connector with 4-hole Flange
						5 Panel Connector with Round Flange
						6 Panel Connector with Hexagonal Flange
						7 Panel Connector with 2-hole Flange
						K Female Connector, Jack
						S Male Connector, Plug
						P Sexless
						W Tool
						Z Accessories
Rosenberger Connector Series Code (overview see next page)						

Packaging

Blister: 2-piece plastic blister in various variants
 Box: Carton in various sizes with various inlays
 Standard: Plastic bag in various sizes
 Tape & Reel: Carrier tapes on on rolls in various variants

details please see chapter Packaging

Rosenberger Standard Plating Code

Outer Contact

Code	Plating	Symbol	Layer thickness	Magnetic Properties
A	Nickel	Ni	3.00 µm	
B	Silver	Ag	3.00 µm	Non magnetic
E	Gold	Au	0.80 µm	
F	Gold	Au	0.10 µm	
H	Gold selective	Au	1.27 µm	
L	AuroDur®	Au	0.15 µm	Non magnetic
N	White bronze*)			Non magnetic
S	Stainless Steel			
T	Tin/Lead	Sn	6.00- 8.00 µm	Non magnetic

*)White bronze (e.g. Optalloy®) Flash white bronze over silver (e.g. Optarger®)

Center Contact

Code	Plating	Symbol	Layer thickness	Magnetic Properties
1	Silver	Ag	3.00 µm	Non magnetic
3	Gold	Au	1.27 µm	
4	Gold	Au	0.80 µm	
5	AuroDur®	Au	0.15 µm	Non magnetic

Plating Code

The used platings of outer and center contacts of Rosenberger connectors are defined by the last two digits of the Rosenberger Number.

Example: 19 S 101 - 40M L5

Plating outer contact: AuroDur® (L) Au 0.15 µ

Plating center contact: AuroDur® (5) Au 0.15 µ

AuroDur® – the Rosenberger Standard Plating for Gold Surfaces

AuroDur® plating is the standard gold surface for all Rosenberger connector series. AuroDur® has been developed by the engineering and metallurgical team at Rosenberger, well-experienced in developing electroplating standard and customized surfaces. The AuroDur® surface consists of a thin gold layer (0.15 µm) on a non-magnetic, chemically deposited layer of nickel (2-3 µm).

AuroDur® gold plating fully satisfies the high mechanical and electrical demands of radio frequency connectors. In contrast to conventional platings, essential characteristics are improved.

Properties:

- ▶ high abrasion and corrosion resistance
- ▶ excellent intermodulation
- ▶ low contact resistance
- ▶ very good solderability
- ▶ optimal distribution of layer thickness
- ▶ RoHS conform

Rosenberger Connector Series Code

Precision Connector Series

Code			
01	RPC-1.00	(W)	- 110GHz
02	RPC-2.92	(K)	- 40GHz
03	RPC-3.50		- 26.5GHz
04	RPC-SL 26.5		- 26.5GHz
05	RPC-N 50Ω		- 18GHz
06	RPC-TNC		- 18GHz
07	RPC-7		- 18GHz
08	RPC-1.85	(V)	- 70GHz
09	RPC-2.40		- 50GHz
10	RPC-SP	(BMA)	- 22GHz
P4	RPC-SL 40		- 40GHz
P5	RPC-N 75Ω		- 4GHz

Classical Coaxial Connector Series

Code	
11	Tools
15	Micro-RF
16	FMC
17	Longwipe-SMP
18	Mini-SMP
19	SMP
20	MMCX
23	Inserts Mini-Coax
24	Mini-UHF
25	Inserts High Voltage DIN 41626
26	FME
27	IEC Antenna 75 Ω
28	QMA
29	MCX
30	SSMA
31	Microdot
32	SMA
32R	SMA reverse
34	1.0-2.3 DIN 47297 50Ω
35	SSMB
38	SSMC
39	SMC
40	MCX 75 Ω
41	MHV (High Voltage BNC)
42	HV 4-10 (High Voltage C)
43	HN (High Voltage N)
45	Inserts 1.0-2.3 DIN 41626 50Ω
47	SSMG
49	SMG
50	Inserts High Power DIN 41626 / D-Sub
51	BNC 50Ω

Code	
51R	BNC reverse
52	C 50Ω
53	N 50Ω
53Q	SnapN
54	UHF
55	Inserts D-Sub
56	TNC 50Ω
56R	TNC Reverse
57	SHV (Safe High Voltage)
59	SMB 50 Ω, FAKRA
60	7-16
64	4.3-10
65	4.1-9.5
71	BNC 75Ω
72	C 75Ω
73	N 75Ω
74	F
75	Inserts 1.0-2.3 DIN 41626 75Ω (intermateable with 50Ω)
76	TNC 75Ω
78	1.6-5.6 II Generation
81	Twinax
88	1.6-5.6 III Generation
99	Specials
119	P-SMP
153Q	QN
734	1.0-2.3 DIN 47297 75 Ω
745	Inserts 0.8-2.7 DIN 41626 75 Ω
759	SMB 75 Ω acc. to BT 43
D4	RosenbergerHSD®
E4	RosenbergerHSD®e

Cable Groups

Cable Group	Impedance	Cable Type
01	50Ω	RG 178, RG 196
02	50Ω	RG 316/U, RG 174 A/U, RG 188, G 022 32
02	75Ω	RG 179, RG 187, L910/22
03	50Ω	RG 316/U-d, K 02252 D, 5YCC6Y 0.54/1.5
03	75Ω	RG 179- d, L 910/19
06	50Ω	RG 58, RG 141
07	50Ω	RG 142, RG 223, RG 400
08	50Ω	RG 142, RG 223, RG 400
09	75Ω	RG 59, G 04233- 2, URM 104, Video 0.6/3.7
10	93Ω	RG 62
11	93Ω	RG 71
12	75Ω	RG 212, RG 222
13	75Ω	Belden 9248, 2YCY 0.80/4.8
14	75Ω	RG 6
15	50Ω	RG 213
16	50Ω	RG 225, RG 393
17	50Ω	RG 214
18	75Ω	RG 11
20	75Ω	RG 216/U
21	50Ω	RG 217
22	50Ω	RG 218
26	75Ω	Video 1.0- 6.6
28	75Ω	BT 2003, G 04233
29	75Ω	G 03233d, 2 S PTT 6012
40	75Ω	RG 180, RG 195, 2YCY 0.4/2.5
41	75Ω	2YCCY 0.4/2.5; 2YC(ms)CY 0.4/2.5
42	75Ω	x2YCY 0.7/4.4
43	75Ω	2YCCY 0.7/4.4
44	75Ω	2YCCY 1.0/6.5
50	75Ω	BT 2001
70	50Ω	UT 47
71	50Ω	UT 85, RG 405/U, RTK- FS 085, RTK- Flex 405
72	50Ω	UT 141, RG 402/U, RTK- FS 141, RTK- Flex 402
73	50Ω	UT 250, RG 401/U, RTK- FS 250
C01	50Ω	Flexible Corrugated Cable 1/4"R
C02	50Ω	Super Flexible Corrugated Cable 3/8"S
C03	50Ω	Flexible Corrugated Cable 1/2"R
C05	50Ω	Flexible Corrugated Cable 7/8"R
C06	50Ω	Flexible Corrugated Cable 1 1/4"R
C07	50Ω	Flexible Corrugated Cable 1 5/8"R
C08	50Ω	Super Flexible Corrugated Cable 1/2"S
C09	50Ω	Super Flexible Corrugated Cable 1/4"S
C15	50Ω	Super Flexible Corrugated Cable 7/8"S
E3	50Ω	RTK 008
H1	50Ω	RTK 013
K9	50Ω	RTK 048, RTK 049
M4	50Ω	RTK 031, RTK 032
N8	50Ω	LMR 200
N9	50Ω	LMR 400, TZC 50032
P7	75Ω	Flex 3
S3	75Ω	R1- T 2.0 LIXI 75K
S4	75Ω	ST 212
T6	75Ω	Tella TM 13
T7	75Ω	Flex 5/75
U1	50Ω	RTK 106, RTK 107
U5	50Ω	RTK 092
U7	50Ω	RTK 161, RTK 161- P, RTK 162, RTK 162- P
U8	50Ω	RTK 125
V2	75Ω	735 A, 02Y(St)CY 0.45/2.0
V4	75Ω	02XSC(ms)C6Y0.45/2.0; 02Y12Y(ms)C6X0.45/2.0
V6	75Ω	BT 3002, TZC 75024, TZC 75025
W7	50Ω	UT 70, UT 70 LL, AA 50070
W9	50Ω	UT 118
X1	50Ω	RG 178 B/U-d
Y4	50Ω	RTK 043, HF50 1.4/3.7 C
Y8	50Ω	RTK 057, TZC 50025

The overview contains our standard cable types and cable groups.
Please note that Rosenberger offers connectors for other cable types.

Company Profile	4	Inserts High Voltage DIN 41626-T2	174
Rosenberger Global Network	4	Inserts Mini-Coax	176
Competences & Technology	6	BNC 50 Ω	180
Quality – Environment – Product Compliance	10	BNC 75 Ω	196
Products & Markets	12	TNC 50 Ω	204
Cable and Cable Assemblies	16	TNC 75 Ω	216
 		N 50 Ω	220
Connector Series	18	N 75 Ω	238
PCB Connectors	20	QN	242
SMP	24	SnapN	250
Longwipe-SMP	36	4.3-10	258
Mini-SMP	42	4.1-9.5	266
FMC	54	7-16	274
MCX 50 Ω	60	SMA Reverse	286
P-SMP	70	BNC Reverse 50 Ω	290
SMA	80	TNC Reverse 50 Ω	292
QMA	110	Micro-RF	296
SMB 50 Ω	124	UHF	304
SMC 50 Ω	134	Mini-UHF	306
SMG 50 Ω	140	FME	308
SMB 75 Ω	142	Microdot	310
SSMB	144	C 50 Ω	312
SSMC	146	MHV (High Voltage BNC)	314
1.6-5.6	150	SHV (Safe High Voltage)	316
1.0-2.3 DIN 47297 50 Ω	154	HV 4-10 (High Voltage C)	318
1.0-2.3 DIN 47297 75 Ω	156	HN (High Voltage N)	320
Inserts Coax 1.0-2.3 DIN 41626-T2 50 Ω	160	 	
Inserts Coax 1.0-2.3 75 Ω, interm. 50 Ω	166	Tools	322
Inserts Coax 0.8-2.7 DIN 41626-T2 75 Ω	168	 	
Inserts Coax D-Sub	170	Packaging, Index	330
Inserts Power DIN 41626-T1 / D-Sub	172		

Our Rosenberger Online Catalog contains the current standard product range with specific details, including data sheets, assembly instructions and panel piercings.

catalog.rosenberger.com

Unser Rosenberger Online Catalog enthält das aktuelle Standard-Produkt-spektrum mit Detailinformationen wie Datenblätter, Montageanleitungen und Montagebohrungen.

catalog.rosenberger.de



Rosenberger Global Network

Rosenberger is one of the worldwide leading suppliers for controlled impedance and optical connectivity solutions, system components for mobile communication networks, data centers and test & measurement and high voltage contact systems.

A global network of Rosenberger research & development and production centers provides innovation, optimized cost structure and outstanding local customer service.

Rosenberger ist einer der weltweit führenden Anbieter von impedanzkontrollierter und optischer Verbindungstechnik, Systemkomponenten für Mobilfunk, Datenzentren und Messtechnik und Hochvolt-Kontaktsystemen für Fahrzeuge.

Ein globales Netzwerk von Rosenberger-Entwicklungs- und Fertigungszentren bietet Innovation, optimierte Kostenstrukturen und lokalen Kundenservice.

USA

Rosenberger North America

- ▶ Plano TX
- ▶ Akron PA
- ▶ Albuquerque NM
- ▶ Pennsauken NJ

Rosenberger Site Solutions, LLC.
Lake Charles LA

Chile

Rosenberger Sudamerica Ltda
Santiago

Brazil

Rosenberger Domex Telecom Ltda
Caçapava-São Paulo



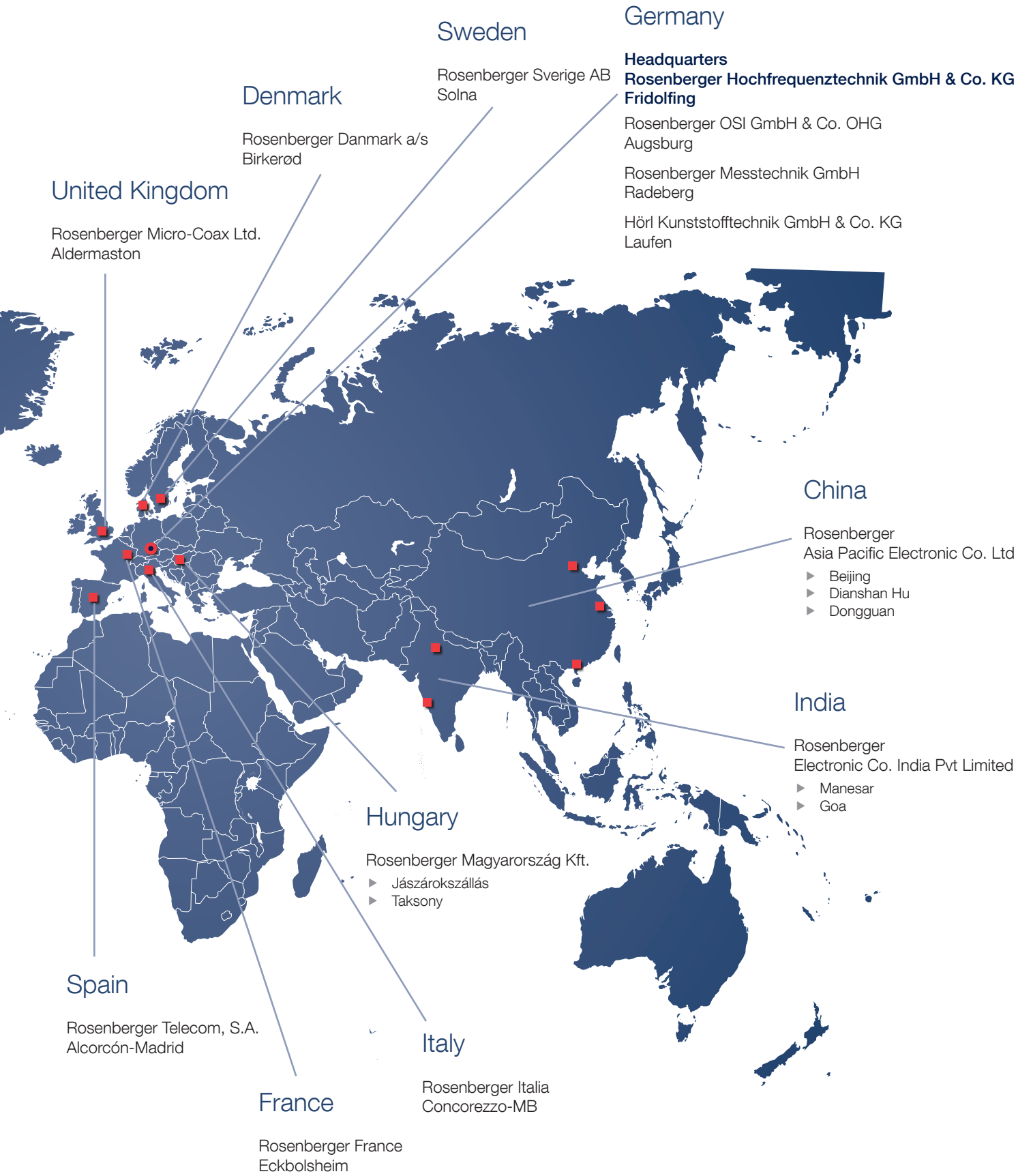

Competences & Technology

Rosenbergers mission is to be counted among the technology and innovation elite of his sector. The most modern manufacturing technology, the highest possible levels of efficiency in production and continuous development are our core competence and guarantee not just fast delivery and strict adherence to delivery dates, but also facilitate the highest demands on the product quality.

Of course, we see our customers as our co-operation and development partners in order to offer the best possible products for various applications and markets.

Rosenberger hat den Anspruch, zur Technologie- und Innovationselite der Branche zu zählen. Modernste Fertigungstechnologien, höchstmögliche Effizienz in der Produktion und kontinuierliche Weiterentwicklung der Kernkompetenzen gewährleisten nicht nur schnellen Liefereinsatz und bestmögliche Termintreue, sondern erlauben auch höchste Ansprüche an die Produktqualität.

Kunden schätzen Rosenberger als Kooperations- und Entwicklungspartner, um anwendungs- und marktgerechte Produkte anbieten zu können.



Production

Complete in-house production guarantees Rosenberger development and optimization scope in key manufacturing technologies – machining and punching/stamping. With its own electroplating facilities and its own injection molding and cable fabrication facilities, Rosenberger exploits the benefits of complete in-house production and can quickly manufacture newly developed, innovative products in the required quantities.

Turned, milled, punched and stamped and formed components of different materials, with and without surface finishes, small or large quantities – Rosenberger has the technologies to quickly and reliably manufacture these parts to the required level of precision.

Produktion

Die durchgängige Eigenfertigung ermöglicht Rosenberger in den wesentlichen Technologien - spanabhebende Fertigung und Stanz-Technik – das Knowhow immer weiter zu entwickeln und zu optimieren. Mit eigenen Galvaniken, Kunststoffspritzguss- und Kabelkonfektionsanlagen nützt Rosenberger Vorteile und Flexibilität einer durchgängigen Produktion im eigenen Hause.

Dreh-, Fräs-, Stanzteile und Stanzbiegeprodukte aus unterschiedlichen Werkstoffen, mit oder ohne Oberfläche, kleine oder große Stückzahlen – Rosenberger verfügt über Technologien, um Teile mit der entsprechenden Präzision schnell und zuverlässig herzustellen.



Plating Technology

Whether corrosion protection, optimized conductivity or other technical and physical features, our components are quickly and flexibly electroplated in the in-house electroplating plant. Environmental protection in surface coating is a significant issue, where emphasis is placed on saving resources, recycling and energy efficiency just as it is in production.

Oberflächentechnologie

Ob Korrosionsschutz, optimierte Leitfähigkeit oder andere technische und physikalische Anforderungen, in der hauseigenen Galvanik werden unsere Bauteile flexibel und schnell galvanisch beschichtet. Umweltschutz in der Oberflächenbeschichtung ist ein zentrales Thema, bei dem, wie auch in der Produktion, größter Wert auf Ressourcenschonung, Recycling und Energieeffizienz gelegt wird.



Company Profile

Assembling

As a global supplier of high-frequency and fiber optic connector solutions, Rosenberger operates many manufacturing and assembly locations around the world for connectors, cable assemblies and cable fabrication.

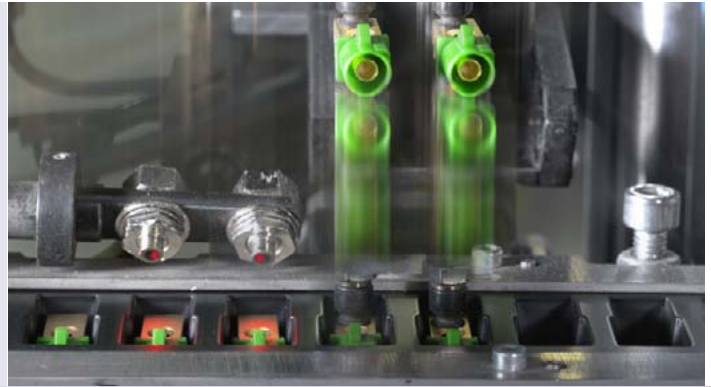

Montage

Als Global Player von Hochfrequenz- und Faseroptik-Verbindungs-lösungen betreibt Rosenberger an vielen Standorten weltweit eigene Fertigungslinien zur Montage von Steckverbindern, Kabelbaugruppen und Kabel-Konfektionierung.



Research & Development

Scientific based high frequency know-how enables us to continuously improve existing products and to design target-oriented innovative products – from standard products or customer specific solutions to high-precision connectors for challenging test and measurement applications. Numerous patents are testament to Rosenberger's innovation and creativity.

Forschung & Entwicklung

Fundiertes, wissenschaftlich begründetes HF-Knowhow bildet die Basis, bestehende Produkte zu optimieren und zielgerichtet neue, innovative Produkte zu entwickeln – von Standard-Produkten über kundenspezifische Lösungen bis hin zu Steckverbindern für Präzisionsanwendungen in der industriellen Messtechnik. Zahlreiche Patente belegen unser Innovationspotential.



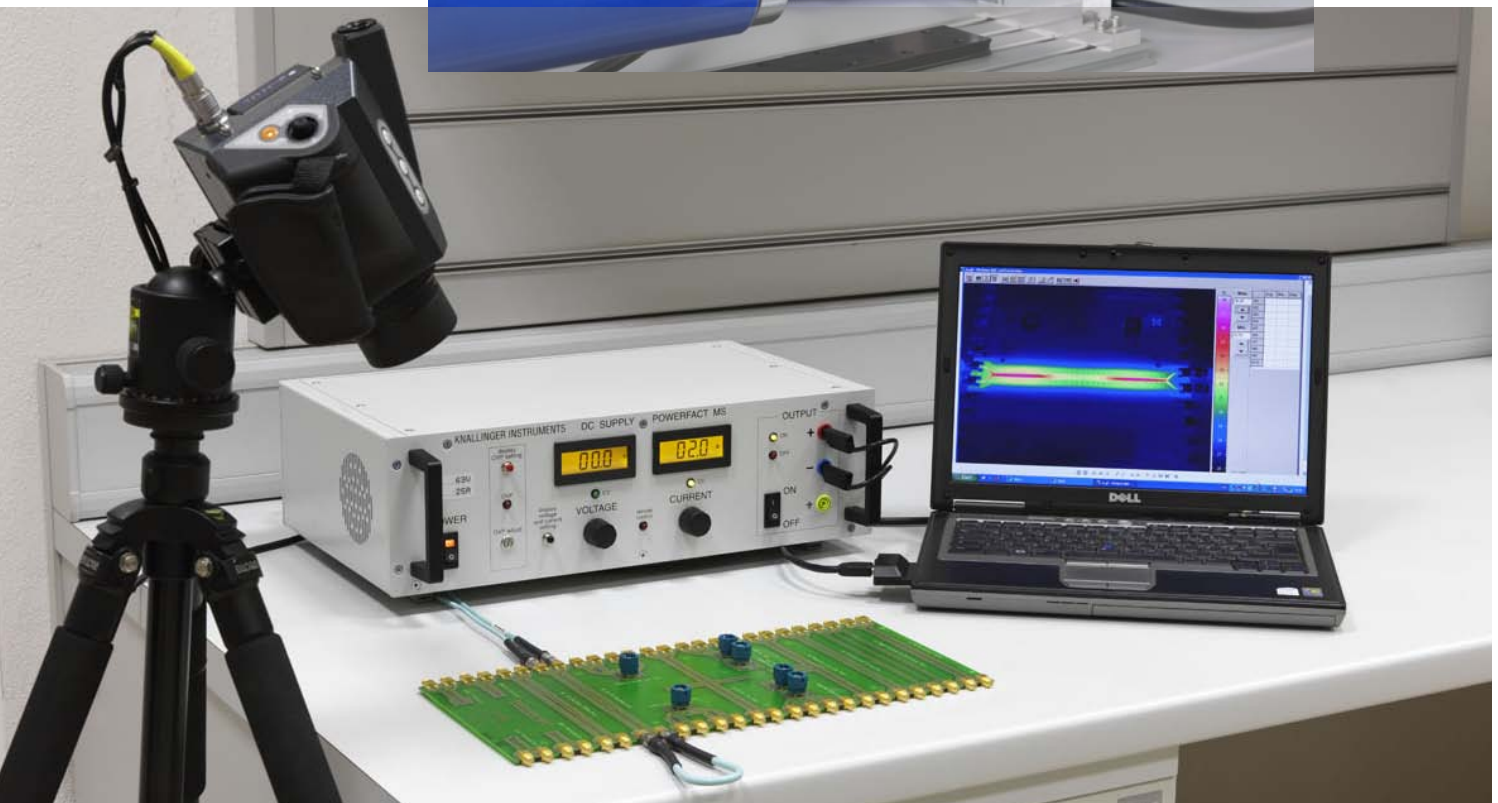
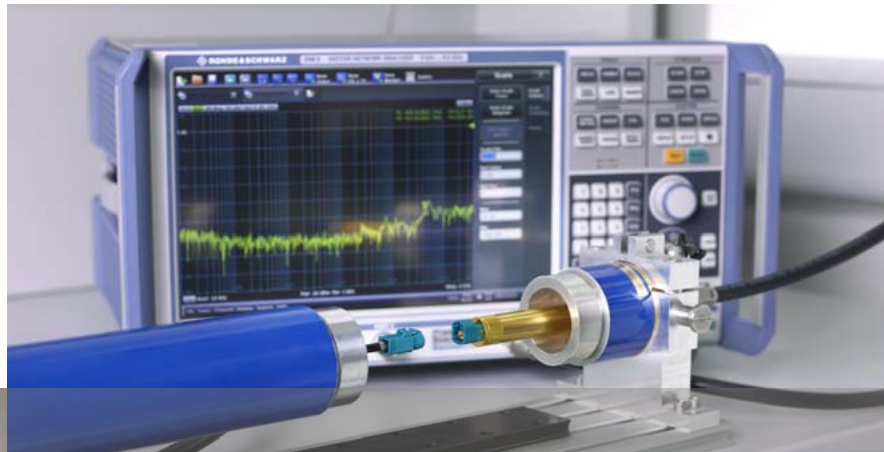

Testing and Qualification

The use of connectors sets high standards on the manufacturing properties with respect to ruggedness and reliability. All products from Rosenberger are accompanied in all stages of product development by the Test laboratory. From the prototype to series production, the connectors are tested using the latest technology. Using the EMC lab, best simulation and analysis equipment and practices, the knowledge gained is applied immediately in the respective departments.

Since 2013 we are accredited as a calibration laboratory according DIN EN ISO/IEC 17025:2005 for electrical measurements/high frequency measurements: RF-Impedance (reflection factor), as well as Rosenberger is a member of the "Deutschen Kalibrierdienst", a part of PTB.

Prüfung & Qualifikation

Alle Produkte von Rosenberger werden in allen Stadien der Produktentstehung, durch das Prüflabor begleitet. Vom Prototyp bis hin zur Serienreife werden die Steckverbinder mit neuester Prüftechnik untersucht. Ausgestattet mit einem EMV-Messlabor und bestem Simulations- und Analyseequipment fließen die gewonnenen Erkenntnisse sofort in die jeweiligen Fachabteilungen ein.

Seit 2013 ist unser Kalibrierlabor nach DIN EN ISO/IEC 17025:2005 akkreditiert für elektrische Messgrößen/Hochfrequenzmessgrößen: HF-Impedanz (Reflexionsfaktor). Zudem ist Rosenberger Mitglied im Deutschen Kalibrierdienst (DKD) im Gremium der PTB.

Quality – Environment – Product Compliance

Superior Quality

The quality of our products and services is an essential part of our corporate strategy. Rosenberger's quality philosophy is not just to optimize components and products, but to continuously improve and optimize all processes to ensure customer satisfaction: from product development, planning, purchasing, production, sales, logistics and service to environmental policy – all in all, to offer maximum benefit to our customers all over the world.

Responsibility for quality also means being proactive in protecting our environment and natural resources. We endeavour to avoid or minimize environmental pollution – even beyond the requirements of legal regulations whenever possible.

Ausgezeichnete Qualität

Die hohe Qualität unserer Produkte und Serviceleistungen ist ein grundlegender Bestandteil unserer Unternehmensstrategie. Die Rosenberger-Qualitätsphilosophie beinhaltet nicht nur die Optimierung aller einzelnen Produkte, sondern auch die kontinuierliche und abteilungsübergreifende Verbesserung und Optimierung aller Unternehmensprozesse: von der Produktentwicklung über Planung, Einkauf, Produktion, Vertrieb, Logistik bis hin zur Umweltpolitik – mit dem Ziel, allen unseren Kunden weltweit größtmögliche Kundenzufriedenheit zu bieten.

Verantwortung für Qualität bedeutet auch umweltbewusstes Handeln und Schutz der natürlichen Ressourcen. Unser Ziel ist es, eine Verschmutzung der Umwelt zu vermeiden, beziehungsweise auf ein Minimum zu beschränken – möglichst deutlich unterhalb der gesetzlich erlaubten Grenzwerte.

Environmental

Environmentally-conscious actions and protection of natural resources are professed company objectives at Rosenberger. A sustainable and careful approach to protecting our environment, avoidance of unnecessary consumption and environmentally responsible use of raw materials are primary concerns. Rosenberger has been certified to ISO 14001 since 1998.

Umwelt

Umweltbewusstes Handeln und Schutz der natürlichen Ressourcen sind erklärtes Unternehmensziel von Rosenberger. Der nachhaltige und behutsame Umgang mit unserer Umwelt und ein sparsamer und ökologischer Einsatz notwendiger Rohmaterialien stehen im Vordergrund. Rosenberger wurde bereits 1998 nach ISO 14001 zertifiziert.

Connectors and cable assemblies manufactured by Rosenberger correspond to the following European Directives:

Die von Rosenberger gelieferten Steckverbinder und Kabel-Assemblies sind mit folgenden EU-Richtlinien konform:

- ▶ 2011/65/EU – Restriction of the Use of Certain Hazardous Substances in Electrical and Electronic Equipment (**RoHS2**)
- ▶ 2012/19/EU – Waste Electrical and Electronic Equipment (**WEEE2**)
- ▶ 2003/11/EG and 2000/53/EC – End of Life Vehicle (**ELV**)
- ▶ IEC 61760-1 – max. soldering temperature +260 °C for 10 sec. for PCB connectors



Product Compliance

Rosenberger monitors and supervises all production, quality and logistic processes with the aim of ensuring compliance with customer requirements.

Our solutions are based on integrated and flexible product compliance and include material and product reliability and safety, recycling, reuse and contractual inspections. Our staff is made aware of the product-compliance problems resulting from environment legislation so as to "live and experience" implementation of them and compliance with them.

Produkt-Compliance

Rosenberger überwacht und kontrolliert die gesamten Produktions-, Qualitäts- und Logistikprozesse mit dem Ziel, die Erfüllung der Kundenanforderungen sicherzustellen.

Unsere Lösungen bauen auf eine integrierte und flexible Produkt-Compliance und beziehen Material- und Produktsicherheit, Recycling, Wiederverwendung sowie Vertragsprüfungen mit ein. Unsere Mitarbeiter sind für die aus der Umweltgesetzgebung resultierende Produkt-Compliance-Problematik sensibilisiert, um deren Umsetzung und Einhaltung zu "leben".

Products & Markets

The Rosenberger product range covers RF connectors, components and accessories right up to cable assemblies. Renowned high-tech companies in fields such as cellular technology and telecommunications, industrial measurement technology, automotive electronics, medical and industrial electronics or data systems trust in the precision and quality of Rosenberger products. The custom machining center manufactures components for sophisticated technical equipment and facilities.

Rosenberger service also incorporates design support and layout recommendations as well as electrical and mechanical simulations and laboratory tests. Rosenberger manufactures complex job-order products on request.

For product information in detail please see our website, our online catalog or use our specific publications, catalogs and brochures.

Das Rosenberger-Produktportfolio umfasst HF-Steckverbinder, -Komponenten und Zubehörteile sowie konfektionierte Kabel. Namhafte HighTech-Unternehmen in Mobil- und Telekommunikation, industrieller Messtechnik, der Automobil-Elektronik, Medizin- und Industrieelektronik oder Datentechnik setzen auf Präzision und Qualität der Rosenberger Produkte. Der Bereich Maschinenbau fertigt Einzelteile für technisch anspruchsvolle Geräte und Anlagen.

Rosenberger bietet neben individueller Kundenberatung, Unterstützung beim Design, Layout-Empfehlungen sowie elektrische und mechanische Simulationen und Labortests. Zudem fertigt Rosenberger auf Kundenwunsch komplexe Lohnfertigungsteile.

Ausführliche Produktinformationen finden Sie auf unserer Website, im Online Katalog und in spezifischen Katalogen, Broschüren und Flyern.

Communication & Site Solutions

As the leading manufacturer of reliable communication systems in landline telecommunication, industrial and data system technology as well as for aerospace engineering applications Rosenberger offers a comprehensive range of products and services.

In addition to classical connection technology with RF connectors and cable assemblies for communications engineering, miniaturized contacts for cable-to-board or board-to-board connections on and between PCBs, Rosenberger also offers innovative fiber-optic products and hybrid solutions. Rosenberger offers PIM measurement devices for determining the passive intermodulation performance in laboratories, production lines and in the field.

Communication & Site Solutions

Als Marktführer für verlässliche Kommunikationssysteme in Mobil- und Festnetzkommunikation, Industrie- und Datentechnik sowie Luft- und Raumfahrt bietet Rosenberger ein umfangreiches Spektrum an Produkten und Dienstleistungen.

Neben der klassischen Verbindungstechnik mit HF-Steckverbindern und Kabelassemblies für die Nachrichtentechnik, miniaturisierten Kontakten für Cable-to-Board- oder Board-to-Board- Verbindungen auf und zwischen Leiterplatten, entwickelt Rosenberger innovative Fiber-Optik-Produkte und Hybridlösungen. Zur Abrundung des Site Solution Portfolios bietet Rosenberger PIM-Messgeräte zur Ermittlung der passiven Intermodulationsperformance für Labor, Fertigung und Feldeinsatz.

Publications:

- ▶ RF Coaxial Connectors Catalog
- ▶ Site Solutions Catalog
- ▶ PCB Connectors Flyer
- ▶ Passive Intermodulation Analyzers Catalog



Test & Measurement

Rosenberger is a dependable and precise development partner in industrial measurement technology. Worldwide cooperation with leading companies engaged in the electronic measurement technology field demonstrates the trust in our research and development, in our high-quality manufacturing and not least in our customer-orientated service "Made in Germany". For customized solutions, Rosenberger offers the capability to provide cost-optimized and timely solutions that complement and increase the value of the measurement components.

Rosenberger offers a comprehensive product range of calibration, verification and gauge kits as well as test cables, interchangeable port connector systems and a range of test components as well as precision connector series.

Test & Measurement

Rosenberger gilt als zuverlässiger und präziser Entwicklungspartner in der industriellen Messtechnik. Weltweite Kooperationen mit führenden Unternehmen zeugen von Vertrauen in unsere Forschung und Entwicklung, in unsere hochwertige Produktion und nicht zuletzt in unseren kundenorientierten Service „made in Germany“. Für kundenspezifische Lösungen bietet Rosenberger die Fähigkeit, kostenoptimiert und zeitnah, Lösungen anzubieten die den Wert ganzer Messkomponenten ergänzen und erhöhen.

Rosenberger bietet ein umfangreiches Produktspektrum an Kalibrier-, Verifizier- und Gauge Kits sowie Testkabel, Wechselport- und vielfältige Testkomponenten bis hin zu den gängigen Präzisionssteckverbinder-Serien.



Publications:

- ▶ Test & Measurement Catalog
- ▶ Test Port Adaptors Flyer
- ▶ Microwave Cable Assemblies Flyer
- ▶ Solderless PCB Flyer
- ▶ Multiport Catalog

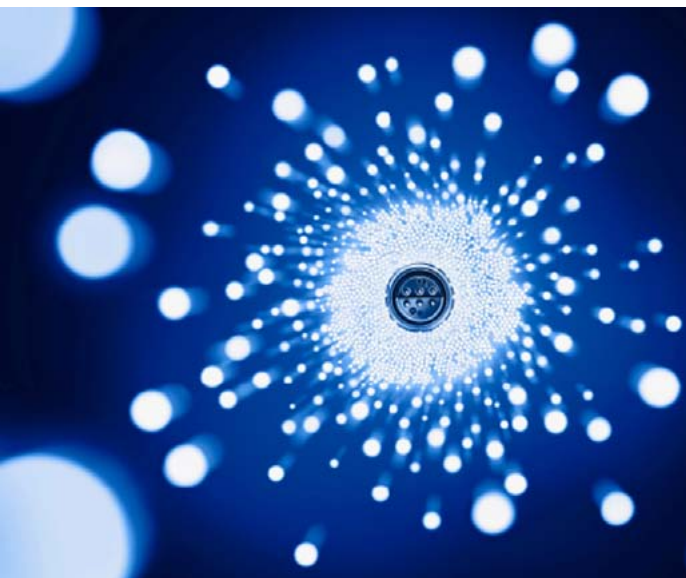

Fiber Optics

You will find the right solution for almost every aspect of fiber optic cabling in the comprehensive Rosenberger product range. Fiber optic connecting systems from universal standard to highly specialized Laser connectors, patch cables and device connection cables as well as fiber optic housings and Data-Center-Racks.

The portfolio offers a comprehensive range of accessories, tools and includes support and cable management system. You can depend on the uncompromising quality and maximum performance.

Fiber Optics

Für nahezu jeden Aspekt der Lichtwellenleiter-Verkabelung finden Sie im umfangreichen Rosenberger-Produktsortiment eine Antwort. LWL-Stecksysteme vom universellen Standard- bis zum hoch spezialisierten Laser-Steckverbinder, über Patchkabel und Geräte-Anschlusskabel sowie LWL-Gehäuse und Data-Center-Racks.

Umfangreiches Zubehör und Werkzeuge und der Kabel-Management-Service runden das Programm ab. Auf kompromisslose Qualität und maximale Performance können Sie sich verlassen.

Publications:

- ▶ Fiber Optic Catalog
- ▶ FTTA Catalog

Medical & Industries

In the medical technology field, diagnostic imaging systems such as MRI (magnetic resonance imaging), PET-CET (positron emission tomography), CT (computer tomography), ultrasound and endoscopy are all key future technologies. Rosenberger offers innovative connector solutions for these applications. Industrial automation deals generally with specific solutions, which are developed in cooperation with the customer. The diverse Rosenberger product range includes high frequency, high voltage, high current, differential, fiber-optic and non-magnetic interface solutions.

Together with partners, Rosenberger also develops innovative system solutions for industrial automation and M2M applications – automated information and communication between electronic systems, machines and equipments.

Medical & Industries

Im Bereich Medizintechnik sind vor allem bildgebende Verfahren wie Magnetresonanztomographie, PET-CT, CT, Ultraschall und Endoskopie die Schlüsseltechnologien der Zukunft. Rosenberger bietet für diese Anwendungen innovative Verbindungslösungen.

Im Bereich Industries konzipiert Rosenberger – gemeinsam mit Partnern – innovative Systemlösungen für industrielle Automatisierung und für M2M-Anwendungen: automatisierter Informationsaustausch und Kommunikation zwischen elektronischen Systemen, Maschinen, Automaten, Geräten und Anlagen.

Das breit gefächerte Produktspektrum umfasst Hochfrequenz-, Hochspannungs-, Hochstrom-, differentielle, fiberoptische und nicht-magnetische Schnittstellenlösungen.

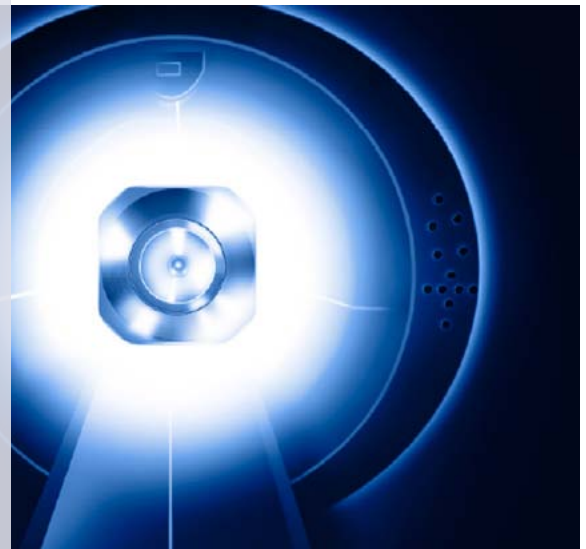

Publications:

- ▶ Medical & Industries Catalog
- ▶ M2M Flyer



Automotive

As an innovative development partner of the automotive industry, Rosenberger supplies coded FAKRA connectors for standardized high-frequency on-board applications in the vehicle. Dynamic development, continues with technical innovations such as the introduction of stamped and formed technology, reproducible cable assembling or the impedance controlled RosenbergerHSD® system, secure a market leadership position for Rosenberger.

At the moment, we are concentrating our know-how on the development and manufacture of connection solutions for hybrid technology and electrical mobility applications for data and power transmission.

Automotive

Als innovativer Entwicklungspartner der Automobilindustrie liefert Rosenberger kodierte FAKRA-Steckverbindungen für genormte hochfrequente Anwendungen im Fahrzeug. Technische Neuerungen wie die Einführung der Stanz-Biegetechnik, der reproduzierbaren Kabelkonfektion oder das impedanzkontrollierte RosenbergerHSD®-System führen zu einer dynamischen Weiterentwicklung und sichern Rosenberger eine hervorragende Position im Markt.

Derzeit konzentrieren wir unser Knowhow auf die Entwicklung und Fertigung von Verbindungslösungen für Anwendungen in der Hybridtechnik und Elektromobilität zur Daten- und Stromübertragung.

Publications:

- ▶ FAKRA Catalog
- ▶ RosenbergerHSD® Catalog
- ▶ Hochvolt Catalog
- ▶ RoPD® Flyer
- ▶ MTD Flyer



Custom Machining Center

Rosenberger "Custom Machining Center" has developed into a specialist for customized, ready-to-install parts and individual components. Our main competence is in the area of turning, drilling, cutting and gearing. By the implementation of the highest technical standards, our custom machining center has become a qualified partner for the drives and commercial vehicle industry as well as for the machine and system builders, where all production stages can be taken on should the customer wish.

We manufacture from the prototype right up to series production for the highest technical demands at a high vertical range of manufacture. We support our customers in the component development stage, take on the raw material procurement and deliver, when required, directly to the assembly line.

Custom Machining Center

Rosenberger Maschinenbau ist auf die Produktion von kundenspezifischen, verbaufertigen Einzelteilen und Komponenten spezialisiert. Unsere Hauptkompetenzen liegen in den Bereichen Drehen, Bohren, Fräsen und Verzahnen. Durch die Umsetzung von höchsten technischen Ansprüchen hat sich unser Maschinenbau zu einem qualifizierten Partner für die Antriebs- und Nutzfahrzeugindustrie sowie für den Maschinen- und Anlagenbau entwickelt.

Wir fertigen vom Prototyp bis zu Serienprodukten für höchste technische Ansprüche bei hoher Fertigungstiefe. Wir unterstützen bereits bei der Bauteileentwicklung, übernehmen die Rohteilebeschaffung und liefern wenn gewünscht direkt an das Montageband.

Cable and Cable Assemblies

Rosenberger offers a comprehensive range of fabricated cables for the areas of communication, automotive and measurement technology. Whether it is RF cables assemblies for mass production, low-priced cables, very robust cables for outdoor applications, attractively priced laboratory test cables or high-precision test & measurement cables – our top priority at Rosenberger is a careful selection of the best-quality materials as well as excellent know-how.

Cable and Cable Assemblies

Für die Bereiche Kommunikation, Automotive und Messtechnik bietet Rosenberger ein umfangreiches Angebot an konfektionierten Kabeln an. Ob Lieferung von HF-Kabeln für Massen Anwendungen, witterungsbeständigen Kabeln für Außenanwendungen, preisgünstigen Laborkabeln oder Entwicklungen von Präzisionsmesskabeln für die Industrie – an oberster Stelle steht bei Rosenberger die sorgfältige Auswahl hochwertiger Materialien und fundiertes Knowhow.

Rosenberger offers a diverse range of RF complete solutions and customized solutions including cable assembling:

- ▶ Flexible cables for wiring of electronic devices, building installation and navigation systems
- ▶ Microwave cables for precision cables for industrial test & measurement
- ▶ Semi-flexible cables and
- ▶ Semi-rigid cables for splitter and filter systems, plug-in chassis systems
- ▶ Corrugated cables for outdoor applications, e.g. mobile antennas and cable TV
- ▶ High voltage cables for power transmission in hybrid and electric vehicles
- ▶ Power data cables for data communication and power transmission in LEV, e.g. scooters, bikes and Pedelecs as well as electrical wheelchairs.

Rosenberger bietet vielfältige HF-Komplettlösungen und kundenspezifische Lösungen inklusive Kabelkonfektionierung:

- ▶ Flexible Kabel für die Verkabelung z.B. von Endgeräten, Gebäudeinstallationen und Navigationssystemen
- ▶ Mikrowellen-Kabel für Präzisionskabel in der industriellen Messtechnik
- ▶ Semi-Flex-Kabel und
- ▶ Semi-Rigid-Kabel für Verteiler-, Filter- und Einschubsysteme
- ▶ Wellmantel-Kabel für die Verkabelung im Außenbereich, z.B. Mobilfunkantennen und Kabelfernsehen
- ▶ Hochvolt-Kabel für die Stromversorgung in Hybrid- und Elektro-Fahrzeugen
- ▶ Power-Data-Kabel für die kombinierte Strom- und Datenversorgung in LEV, z.B. Elektroroller, -fahrräder und Pedelecs sowie in Elektrorollstühlen.

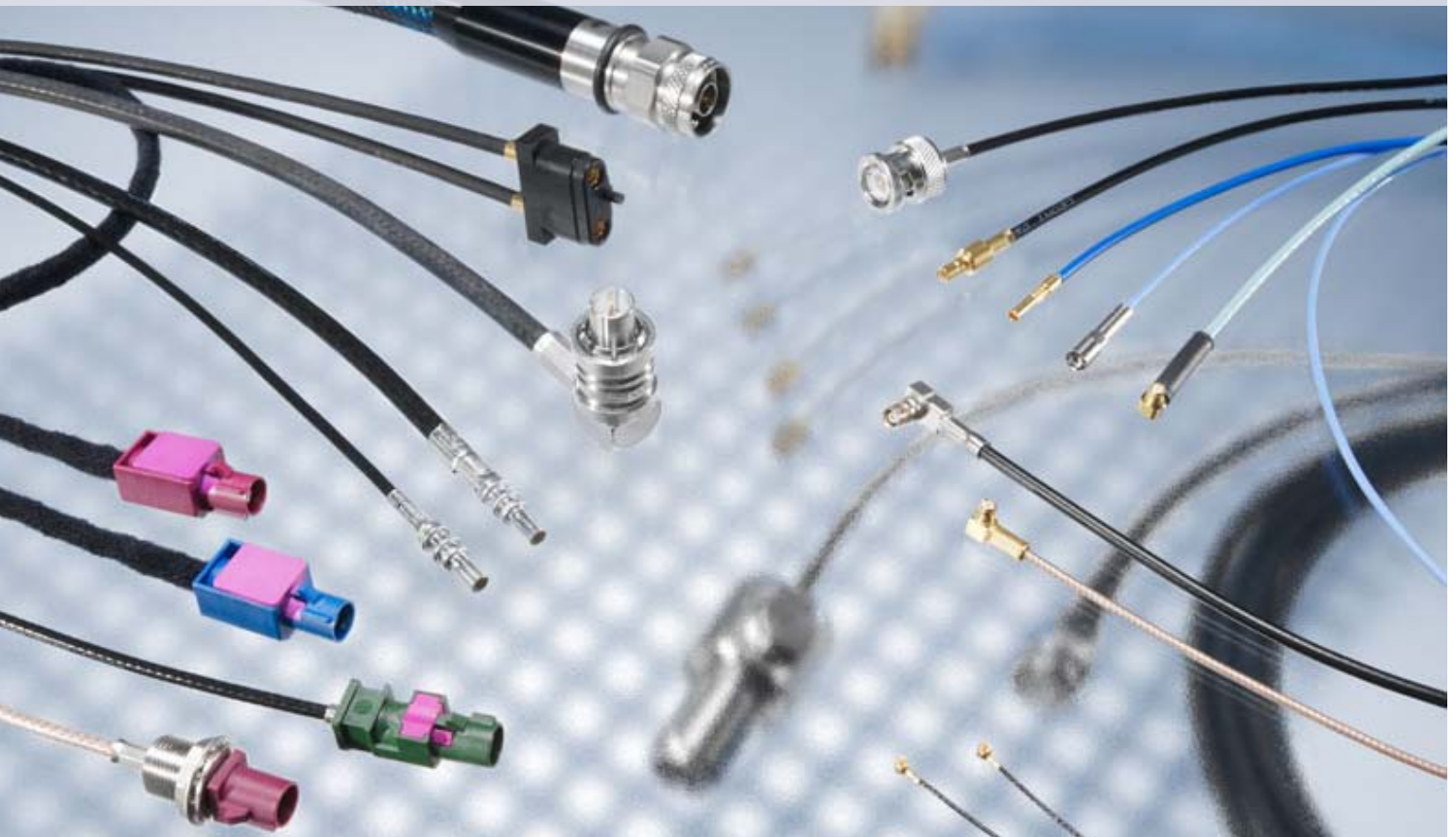

Manual and Automated Cable Assembling

Rosenberger knows and masters every detailed step in the overall assembling process. This is a prerequisite on the way to partially and fully automated assembly. Rosenberger employs all cable assembling processes and is therefore in a position to manufacture everything in the range from an individual measurement cable right up to large scale production.

Fully automated cable assembling starts in the product development phase. The thought-out construction of a cable assembly clears the way for automation. All process steps up to engineering design of fully automatic assembly machines are defined in the concept phase.

Manuelle und automatisierte Kabelkonfektion

Je nach Anforderung, werden bei Rosenberger Kabel manuell oder in teil- und vollautomatisierter Montage konfektioniert. Rosenberger wendet alle Verfahren der Kabel-Konfektion an und ist daher in der Lage, von der einzelnen Messleitung bis zur Großserie, die ganze Palette zu fertigen.

Eine vollautomatisierte Kabelkonfektion beginnt bereits in der Produktentwicklung. Die durchdachte Konstruktion eines Kabelassemblies ebnet den Weg in die Automatisierung.

Bereits in der Konzeptphase werden alle Prozessschritte bis zur Projektierung von vollautomatischen Montagemaschinen festgelegt.

Microwave Cable Assemblies

Rosenberger offers a standard portfolio of flexible microwave cable assemblies in defined lengths for applications up to 70 GHz, customer-specific assemblies and solutions are available on request.

Outstanding characteristics are very high phase-stability and a high number of mating cycles. The variety of cable types and connector interfaces enables various industrial test & measurement applications.

Mikrowellen Kabelassemblies

Für Anwendungen bis 70 GHz steht ein Standard-Spektrum an Microwave Cable Assemblies in definierten Längen zur Verfügung, kundenspezifische Lösungen sind auf Nachfrage erhältlich.

Herausragende Eigenschaften der Kabelleitungen sind sehr hohe Phasenstabilität sowie hohe Steckzyklen. Die angebotenen Kabeltypen und Steckverbinder-Serien ermöglichen vielfältige Anwendungen in der industriellen Messtechnik

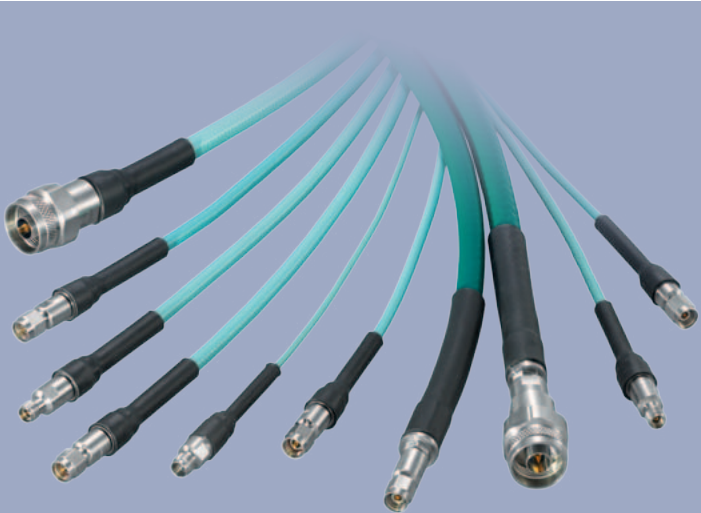

Chip Test Systems

Rosenberger offers a wide range of multiport connections to meet the ever challenging requirements of the semiconductor test equipment industry. The electrical testing of highly-complex cables for chip testers is undertaken by measurement robots constructed by Rosenberger.

Chip-Testsysteme

Rosenberger bietet für die hohen Anforderungen in der Halbleitermesstechnik eine Reihe von Multiport-Verbindungen an. Die elektrische Prüfung der hochkomplexen Leitungen für Chip-Tester erfolgt durch bei Rosenberger konstruierte Messroboter.

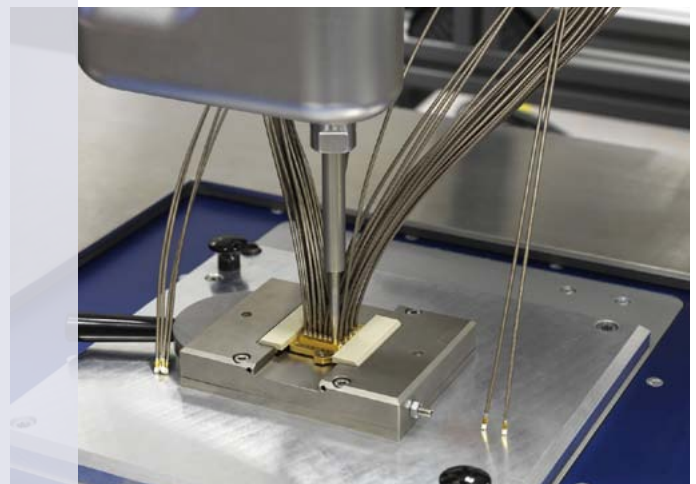

SMP, Longwiper-SMP, Mini-SMP



SMP, Longwiper-SMP and Mini-SMP coaxial connector series are available with different retention variants, main application fields are as PCB connectors and in board-to-board connections. Using adaptors, so-called bullets, equalization of radial and axial misalignments is possible, maintaining constant electrical characteristics. Bullets are available in different lengths to enable any board spacing e.g. from 7.94 mm (Mini-SMP).

Die Koaxial-Steckverbinder-Serien SMP, Longwiper-SMP und Mini-SMP werden in verschiedenen Festhaltevarianten angeboten und vor allem als PCB-Steckverbinder und in Board-to-Board-Verbindungen eingesetzt. Durch Verwendung von Adaptern, sogenannten Bullets, wird mechanischer Toleranzausgleich ermöglicht bei weiterhin ausgezeichneten elektrischen Eigenschaften. Bullets sind in verschiedenen Längen lieferbar, wodurch Leiterplattenabstände beispielsweise ab 7,94 mm (Serie Mini-SMP) möglich sind.

SMP
Longwipe-SMP
Mini-SMP

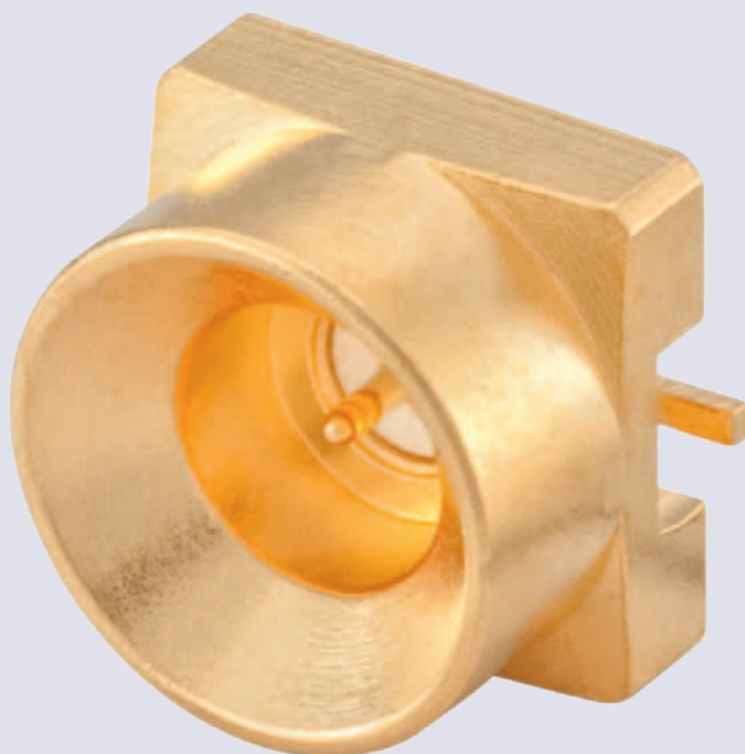

PCB Connectors

Rosenberger provides a wide range of RF coaxial connectors for PCB applications. A wide range of retention and installation variants are available. The range incorporates straight and angled Cable-to-Board connections for common standard RF series such as SMA, QMA, SMB or MCX as well as Board-to-Board connectors for innovative coaxial series such as SMP, Longwipe-SMP, P-SMP, FMC, Mini-SMP and Micro-RF.

The surface-mount technology facilitates very good transmission characteristics and automatic installation using the special tape & reel packaging. In addition to small Board-to-Board distances, essential characteristics are equalization of radial and axial misalignments, the different holding forces and a fast and cost-effective assembly design.

The quality of surface mount connections is dependent on several parameters, such as substrate thickness and board-stack-up. Rosenberger offers tailor-made footprints and layout recommendations for customized applications. The quality of surface mount connections is dependent on several parameters, such as substrate thickness and board-stack-up.

Rosenberger offers tailor-made footprints and layout recommendations for customized applications.

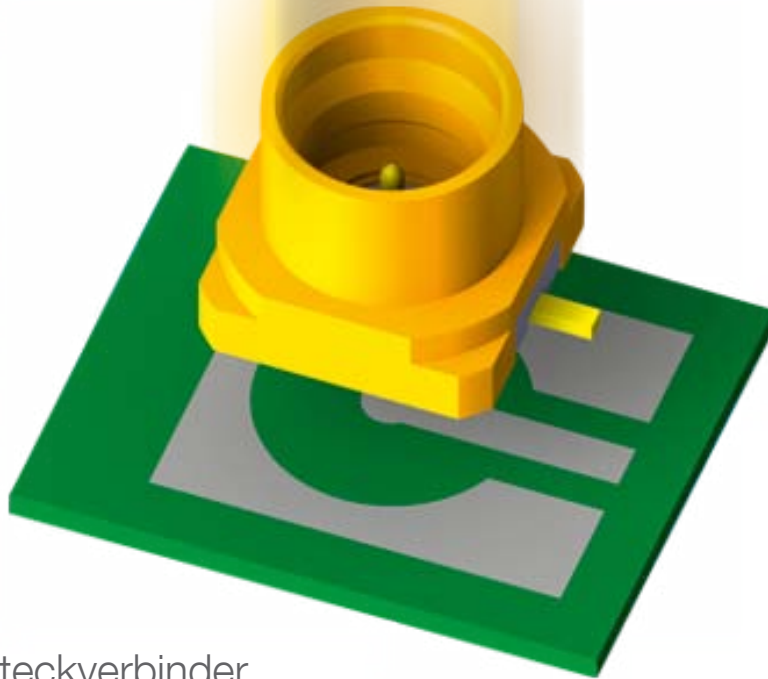

Leiterplatten-Steckverbinder

Rosenberger verfügt über eine breite Palette von koaxialen HF-Steckverbindern für PCB-Anwendungen. Vielfältige Festhalte- und Montage-Varianten stehen zur Verfügung. Das Spektrum umfasst gerade und gewinkelte Cable-to-Board-Steckverbinder z.B. der Serien SMA, QMA, SMB oder MCX und zudem Board-to-Board-Steckverbinder aller innovativen Koaxial-Serien wie SMP, Longwipe-SMP, P-SMP, FMC, Mini-SMP und Micro-RF.

Die Surface-Mount-Technologie ermöglicht sehr gute Übertragungseigenschaften und automatische Montage durch spezielle Tape & Reel-Verpackungen.

Wesentliche Merkmale sind, neben der geringen Board-to-Board-Abstände, der axiale und radiale Toleranzausgleich, die verschiedenen Festhaltekräfte und ein schnelles und kostengünstiges Baugruppendesign. Die Qualität der Surface-Mount-Anschlüsse ist abhängig von einer Vielzahl von Parametern, wie z.B. Substratstärke und Board-Stack-up.

Rosenberger bietet maßgeschneiderte Footprints und Layoutempfehlungen für kundenspezifische Anwendungen.

Retention Variants

Smooth bore

Sliding contact

For modular systems, backplane applications

Catchers mitt

Sliding contact with extended catching range

For modular systems, backplane applications

Limited detent

Medium-tight retention

For applications with low to medium mechanical loads: telecommunications and test and measurement applications

Full detent

Fixed retention, vibration resistant

For high mechanical loads, e.g. in aerospace applications



Festhaltevarianten

Smooth bore

Gleitender Kontakt

Für Einschubtechnik, Backplane-Anwendungen

Catchers mitt

Gleitender Kontakt mit erweitertem Fangbereich für lange Board-to-Board-Verbindungen

Für Einschubtechnik, Backplane-Anwendungen

Limited detent

Mittelfeste Verrastung

Für Anwendungen mit geringer bis mittlerer mechanischer Beanspruchung: Telekom- und Messtechnik-Anwendungen

Full detent

Feste Verrastung, vibrationsstabil

Für hohe mechanische Beanspruchungen, z.B. für Anwendungen in Luft- und Raumfahrt

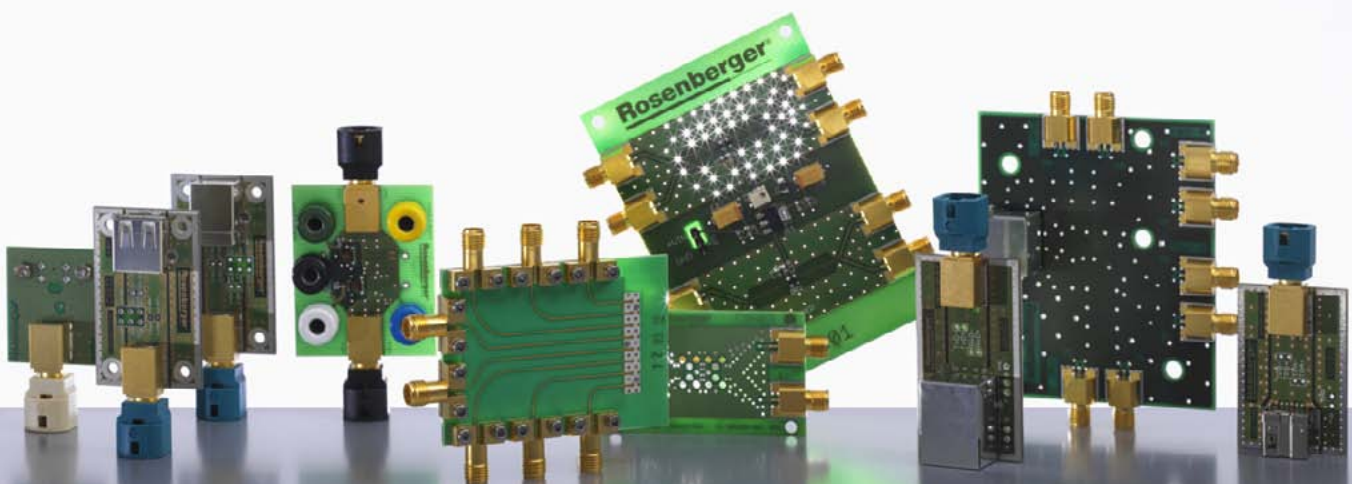

Misalignment with board-to-board connectors

Rosenberger's three-part board-to-board connection consists of a PCB connector with limited or full detent retention on one side and a smooth bore type on the other side, with a bullet in between. This design allows mechanical misalignment, while at the same time guaranteeing excellent electrical performance. It is possible to connect PCBs which are arranged parallel or perpendicular to each other.

Toleranzausgleich mit Board-to-Board-Verbindern

Das dreiteilige Design der Rosenberger Board-to-Board-Verbindern besteht aus einem Leiterplatten-Steckverbinder in Limited-Detent- oder Full-Detent-Ausführung auf der einen Seite und aus einem Smooth-Bore-Typen auf der anderen Seite. Zwischen beide Steckverbinder wird ein Adapter, das so genannte Bullet, eingesetzt. Diese Anordnung ermöglicht einen mechanischen Toleranzausgleich und gewährleistet gleichzeitig ausgezeichnete elektrische Eigenschaften. Es können sowohl senkrecht aufeinander stehende als auch parallel angeordnete Leiterplatten kontaktiert werden.

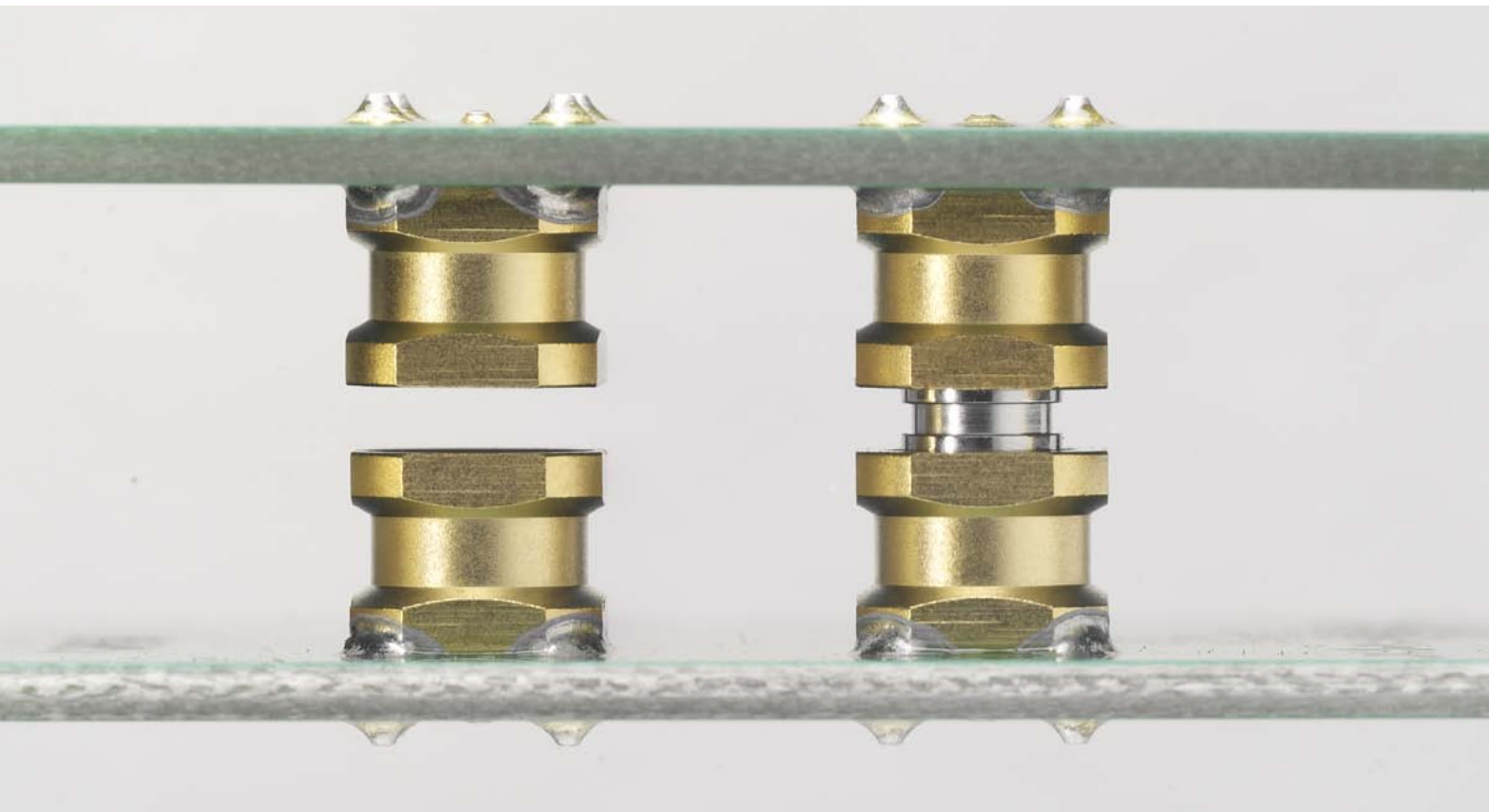

Axial Misalignment

When using a smooth bore type on one side, the connection allows axial misalignment.

It is limited by the sliding surface of the outer contact. Depending on the used connector series, different tolerance ranges are covered. With simultaneous radial misalignment applied to the connection, the maximum axial misalignment is reduced accordingly.

Axialer Toleranzausgleich

Der axiale Toleranzausgleich ist möglich bei Verwendung eines Smooth-Bore-Steckverbinders auf der einen Seite der Leiterplattenverbindung.

Er ist begrenzt durch die maximale Gleitfläche des Außenleiters. Abhängig von der eingesetzten Steckverbinder-Serie werden unterschiedlich große Toleranzbereiche abgedeckt. Bei gleichzeitigem radialen Toleranzausgleich verringert sich der maximale axiale Toleranzausgleich entsprechend.

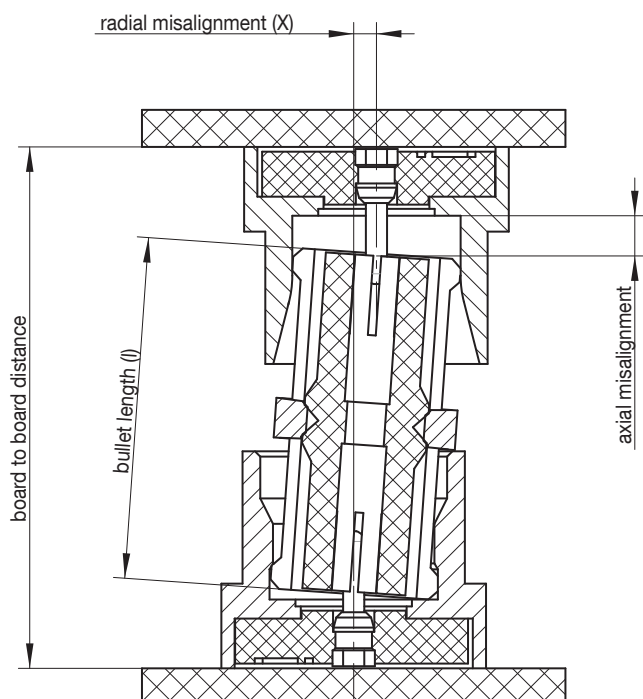
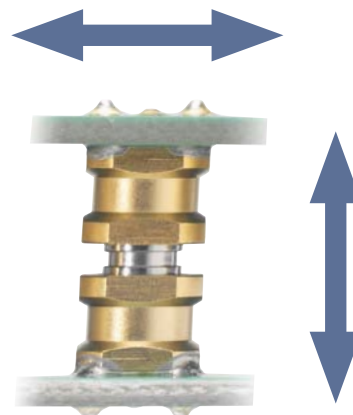

Radial Misalignment

The maximum radial misalignment of the three-part board-to-board connection is dependent on the length of the bullet. It can be easily calculated by using following formula:

$$X = l \times \sin \alpha$$

X = maximum radial tolerance [mm]

α = maximum angle 4°

l = bullet length [mm]

Radialer Toleranzausgleich

Die maximale radiale Toleranz bei der dreiteiligen Leiterplattenverbindung ist abhängig von der Länge des verwendeten Bullets und kann mit einer einfachen Formel berechnet werden:

$$X = l \times \sin \alpha$$

X = maximale radiale Toleranz [mm]

α = maximaler Winkel 4°

l = Länge des Bullets [mm]

Interface Dimensions SMP

Code 19

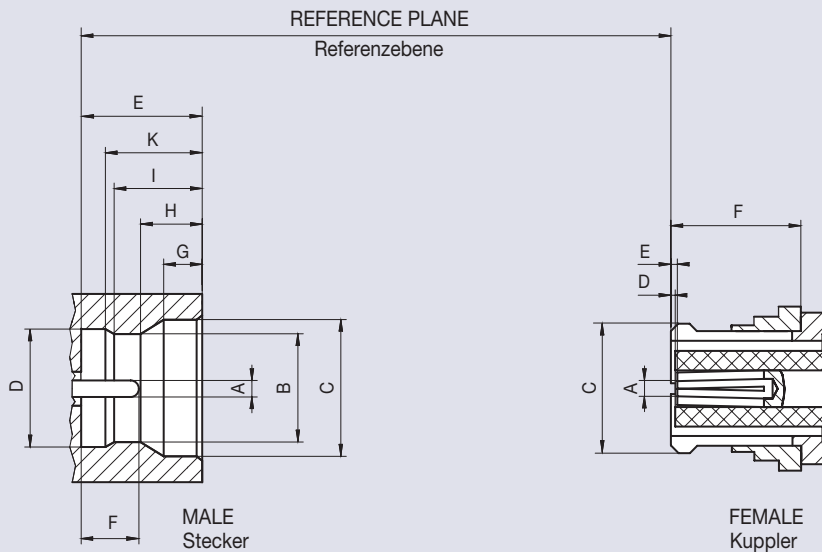

	Male Stecker						Female Kuppler	
	Smooth bore		Limited detent		Full detent		min.	max.
	min.	max.	min.	max.	min.	max.		
A	Ø 0.36	Ø 0.41	Ø 0.36	Ø 0.41	Ø 0.36	Ø 0.41	1)	
B	Ø 3.12	Ø 3.23	Ø 3.00	Ø 3.10	Ø 2.90	Ø 3.00	-	-
C	Ø 3.53	Ø 3.68	Ø 3.53	Ø 3.68	Ø 3.53	Ø 3.68	-	Ø 3.43
D	-	-	Ø 3.15	Ø 3.20	Ø 3.15	Ø 3.20	0.00 nom.	
E	2.74	2.84	2.74	2.84	2.74	2.84	0.20 nom.	
F	1.14	1.40	1.14	1.40	1.14	1.40	2.84	-
G	0.84	0.94	0.84	0.94	0.84	0.94	-	-
H	-	-	1.40	1.45	1.40	1.45	-	-
I	-	-	1.98	2.08	1.98	2.08	-	-
K	-	-	2.19	2.29	2.19	2.29	-	-

Dimensions in mm

¹⁾ Resilient, dimension to meet electrical and mechanical requirements

SMP coaxial connectors are available as smooth bore, catchers mitt, limited detent and full detent versions, they are suitable for a wide range of board-to-board interconnect applications up to 40 GHz - from low up to the highest mechanical loads, e.g. in telecommunication, test & measurement or aerospace applications.

SMP connectors are mateable with GPO™ connectors. PCB connectors are supplied in tape & reel packaging.

SMP-Koaxial-Steckverbinder werden in den Festhaltevarianten Smooth bore, Catchers mitt, Limited detent und Full detent angeboten und eignen sich für vielseitige Board-to-Board-Verbindungen bis 40 GHz von geringer bis zu höchster mechanischer Beanspruchung, z.B. in Telekom- und Messtechnik-Anwendungen bis zu Anwendungen in Luft- und Raumfahrt.

SMP Steckverbinder sind steckkompatibel mit GPO™ Steckverbindern. PCB-Steckverbinder werden in Blistergurt-Verpackungen ausgeliefert.

Features

- ▶ Interface according to US MIL-STD 348A, Fig. 326
- ▶ Frequency range DC to 40 GHz
- ▶ Return loss (cable connector straight) ≥ 23 dB @ DC to 20 GHz
- ▶ Impedance 50 Ω
- ▶ Minimum board-to-board distance ≥ 9.05 mm
- ▶ Snap-on coupling

Product Range

- ▶ Cable connectors
- ▶ PCB connectors
- ▶ Panel connectors
- ▶ Adaptors
- ▶ Terminations

Technical Data SMP

Code 19

Applicable standards Anwendbare Normen	
Interface according to Interface gemäß	MIL-STD-348A, Fig. 326 Mateable with GPO™ (Gilbert Engineering Co., Inc)
Electrical data Elektrische Daten	
Impedance Wellenwiderstand	50 Ω
Frequency range Frequenzbereich	DC to 40 GHz
Return loss (cable connector straight) Rückflusdämpfung (Kabelsteckverbinder gerade)	≥ 23 dB @ DC to 20 GHz ≥ 14 dB @ 20 GHz to 40 GHz
Insertion loss Dämpfung	≤ 0.1 × √f (GHz) dB
Insulation resistance Isolationswiderstand	≥ 5 GΩ
Center contact resistance Übergangswiderstand Innenleiter	≤ 6 mΩ
Outer contact resistance Übergangswiderstand Außenleiter	≤ 2 mΩ
Test voltage Prüfspannung	500 V rms
Working voltage Betriebsspannung	335 V rms
Power handling Leistungsbelastbarkeit	65 W @ 2.2 GHz
Contact current Kontaktstrombelastbarkeit	≤ 1.2 A DC
RF leakage - Interface Schirmdämpfung	≥ 85 dB @ DC to 4 GHz
Mechanical data Mechanische Daten	
Mating cycles Steckzyklen	Full detent: ≥ 100 Limited detent: ≥ 500 Smooth bore, Catchers mitt: ≥ 1000
Center contact captivation Innenleiter Haltekraft	axial: ≥ 7 N
Engagement force Steckkraft	Full detent: ≤ 68 N Limited detent: ≤ 45 N Smooth bore, Catchers mitt: ≤ 9 N
Disengagement force Ziehkraft	Full detent: ≥ 22 N Limited detent: ≥ 9 N Smooth bore, Catchers mitt: ≥ 2.2 N
Axial misalignment Axialer Toleranzausgleich	± 0.3 mm
Radial misalignment Radialer Toleranzausgleich	4° (interface)
Board-to-board distance (min.) Board-to-Board Abstand (min.)	9.05 mm (solder paste thickness not included)
Environmental data Umweltdaten	
Temperature range Temperaturbereich	-65 °C to +155 °C
Thermal shock Temperaturzyklen	MIL-STD-202, Method 107, Condition B
Damp heat Feuchte Wärme	IEC 60068-2-78 (40 °C, 93% RH, 56d)
Climatic category Klimakategorie	IEC 61169-1, Sub-clause 9.4.5 (+155 °C, 1000 hours)
Moisture resistance Feuchtigkeitsbeständigkeit	MIL-STD-202, Method 106
Vibration Vibration	MIL-STD-202, Method 204, Condition B
Shock Schock	MIL-STD-202, Method 213, Condition A
Max. soldering temperature (PCB connectors) Max. Löttemperatur (Leiterplattensteckverbinder)	IEC 61760-1, +260 °C for 10 sec.
Materials Materialien	
Spring loaded contact parts Federnde Kontaktteile	CuBe, Au plating
Center contact Innenleiter	CuZn, Au plating
Outer contact Außenleiter	CuZn, Au plating
Crimping ferrule Crimphülse	Cu, Au plating
Dielectric Dielektrikum	PTFE / PEEK / LCP



Rosenberger connectors generally fulfill the indicated technical data. Individual values of connectors may deviate depending upon application, design, type of cable, assembly method and workmanship. Data sheets for particular products can be downloaded on our website or can be provided on request from your Rosenberger sales partner.

Rosenberger-Steckverbinder erfüllen grundsätzlich die hier angegebenen technischen Daten. Je nach Anwendung, Bauart, Kabeltyp, Montageart und -ausführung können einzelne Werte der Steckverbinder hiervon abweichen. Datenblätter zu einzelnen Produkten können Sie von unserer Website herunterladen oder auf Anfrage von Ihrem Rosenberger-Ansprechpartner erhalten.

Cable Connectors Semi-Rigid Cables



Straight Plug, solder Panel mount; hexagonal flange

Semi-Rigid Cables

Rosenberger No.	Order No.	Sales Unit	Packaging	Remarks	Cable Group	
19 S 601-271 L5	179837	100	standard	Limited detent rear mount	71	
19 S 641-271 L5	108028	100	standard	Smooth bore rear mount	71	
19 S 602-271 L5	139095	100	standard	Limited detent snap-in	71	

Straight Jack, solder

Semi-Rigid Cables

Rosenberger No.	Order No.	Sales Unit	Packaging	Remarks	Cable Group	
19 K 101-270 L5	192320	50	standard	Frequency: DC to 26.5 GHz	70	
19 K 107-270 L5	163569	50	standard	Frequency: DC to 40 GHz	70	
19 K 101-271 L5	189301	100	standard	Frequency: DC to 26.5 GHz	71	
19 K 107-271 L5	192325	100	standard	Frequency: DC to 40 GHz	71	
19 K 101-272 L5	135145	50	standard	Frequency: DC to 26.5 GHz	72	

Right Angle Jack, solder

Semi-Rigid Cables

Rosenberger No.	Order No.	Sales Unit	Packaging	Remarks	Cable Group	
19 K 202-270 L5	145500	100	standard	Frequency: DC to 26.5 GHz	70	
19 K 202-271 L5	192102	100	standard	Frequency: DC to 26.5 GHz	71	

Cable Connectors - Flexible Cables

Straight Jack, crimp

Flexible Cables

Rosenberger No.	Order No.	Sales Unit	Packaging	Cable Group	
19 K 102-101 L5	146101	50	standard	01	
19 K 101-102 L5	183540	100	standard	02	
19 K 101-103 L5	183543	100	standard	03	
19 K 102-1X1 L5	107932	100	standard	X1	

Right Angle Jack, solder-crimp



Flexible Cables

Rosenberger No.	Order No.	Sales Unit	Packaging	Cable Group	
19 K 202-301 L5	183546	100	standard	01	
19 K 201-302 L5	183483	100	standard	02	
19 K 201-303 L5	151723	100	standard	03	
19 K 203-3X1 L5	169113	25	standard	X1	

Panel Connectors - Coaxial End

Panel Plug

Coaxial End

Rosenberger No.	Order No.	Sales Unit	Packaging	Remarks	
19 S 105-500 L5	186175	100	blister	Limited detent	
19 S 181-5H0 E4	139397	100	blister	Full detent hermetic sealed	

Panel Plug, hexagonal flange



Coaxial End

Rosenberger No.	Order No.	Sales Unit	Packaging	Remarks	
19 S 601-500 L5	157742	100	blister	Limited detent Panel feed through	

PCB Connectors - SMD

Straight Plug, PCB

SMD

Rosenberger No.	Order No.	Sales Unit	Packaging	Remarks		
19 S 101-40M L5	179930	1500	tape & reel	Limited detent		
	180774	100	blister			
19 S 10H-40M L5	182497	1500	tape & reel	Limited detent removable plastic cap on suction area		
	148138	100	blister			
19 S 141-40M L5	145799	1500	tape & reel	Smooth bore		
	179999	100	blister			
19 S 14H-40M L5	147074	1500	tape & reel	Smooth bore removable plastic cap on suction area		
19 S 102-40M L5	136644	1500	tape & reel	Limited detent removable plastic cap on suction area Frequency: DC to 40 GHz		
	141613	100	blister			
19 S 122-40M L5	102524	100	blister	Limited detent, stainless steel removable plastic cap on suction area Frequency: DC to 40 GHz		
19 S 144-40M L5	135686	750	tape & reel	Catchers mitt		
	183482	100	blister			
19 S 14K-40M L5	151875	750	tape & reel	Catchers mitt removable plastic cap on suction area		
19 S 104-40M L5	102294	1500	tape & reel	Catchers mitt		
	142205	100	blister			
19 S 14L-40M L5	272608	750	tape & reel	Limited detent		
	174585	100	blister			
19 S 106-500 L5	107111	100	blister	Limited detent, pin length 0.8 mm pin-in-paste removable plastic cap on suction area		
19 S 103-500 L5	182496	100	blister	Limited detent, pin length 2.5 mm pin-in-paste		
19 S 103-400 L5	104517	750	tape & reel	Limited detent pin-in-paste		
	180770	100	blister			
19 S 10A-400 L5	146632	500	tape & reel	Limited detent pin-in-paste removable plastic cap on suction area		
	148157	100	blister			

Straight Plug, PCB, panel mount

SMD

Rosenberger No.	Order No.	Sales Unit	Packaging	Remarks	
19 S 10D-40M L5	183477	100	blister	Limited detent rear mount	

Right Angle Plug, PCB



SMD

Rosenberger No.	Order No.	Sales Unit	Packaging	Remarks	
19 S 201-40M L5	179841	1500	tape & reel	Limited detent removable sticker on suction area	
	182011	100	blister		
19 S 241-40M L5	197991	1500	tape & reel	Smooth bore removable sticker on suction area	
	189070	100	blister		
19 S 202-40M L5	167254	1500	tape & reel	Limited detent	
	167257	100	blister		
19 S 242-40M L5	171438	1500	tape & reel	Smooth bore	
	138377	100	blister		

PCB Connectors - Solder Pin

Straight Plug, PCB

Solder Pin

Rosenberger No.	Order No.	Sales Unit	Packaging	Remarks	
19 S 102-400 L5	182508	50	blister	Limited detent	
19 S 145-400 L5	145152	750	tape & reel	Smooth bore	
	142203	100	blister		

Right Angle Plug, PCB

Solder Pin

Rosenberger No.	Order No.	Sales Unit	Packaging	Remarks	
19 S 201-400 L5	102064	100	blister	Limited detent	

Adaptors

Bullets SMP female-female



Rosenberger No.	Order No.	Sales Unit	Packaging	Board-to-Board Distance ^{1) 3)}	Bullet Length ²⁾	
19 K 101-K00 L5	180771	100	standard	9.35 mm ± 0.3 mm	6.45 mm	
19 K 102-K00 L5	167255	100	standard	9.90 mm ± 0.3 mm	7.00 mm	
19 K 110-K00 L5	183484	50	standard	11.10 mm ± 0.3 mm	8.20 mm	
19 K 106-K00 L5	203609	100	standard	11.50 mm ± 0.3 mm	8.60 mm	
19 K 109-K00 L5	183527	250	standard	12.80 mm ± 0.3 mm	9.90 mm	
19 K 108-K00 L5	183530	250	standard	14.30 mm ± 0.3 mm	11.40 mm	
19 K 114-K00 L5	183523	100	standard	15.49 mm ± 0.3 mm	12.59 mm	
19 K 119-K38 L5	254062	25	standard	17.78 mm ± 0.3 mm	14.88 mm	
19 K 104-K00 L5	192074	250	standard	19.64 mm ± 0.3 mm	16.74 mm	
19 K 119-K11 L5	185638	25	standard	20.10 mm ± 0.3 mm	17.20 mm	
19 K 115-K00 L5	162598	50	standard	22.40 mm ± 0.3 mm	19.50 mm	
19 K 119-K00 L5	151931	25	standard	23.20 mm ± 0.3 mm	20.30 mm	
19 K 117-K00 L5	145147	25	standard	25.29 mm ± 0.3 mm	22.39 mm	
19 K 107-K00 L5	148746	100	standard	26.70 mm ± 0.3 mm	23.80 mm	
19 K 116-K00 L5	145516	50	standard	27.09 mm ± 0.3 mm	24.19 mm	
19 K 119-K06 L5	201131	100	standard	40.45 mm ± 0.3 mm	37.55 mm	

1) When standard SMD-connectors are applied (e.g. 19 S 101-40M, 19 S 144-40M, ...).

2) Bullets with other lengths on request.

3) Solder paste thickness not included.

Adaptors SMP - SMP

Rosenberger No.	Order No.	Sales Unit	Packaging	Remarks	Return Loss	
19 S 101-S20 D3	106021	1	standard	SMP male - male calibration adaptor	≥ 26 dB @ DC to 4 GHz ≥ 20 dB @ 4 GHz to 18 GHz	
19 S 101-K20 D3	104358	1	standard	SMP male - female calibration adaptor	≥ 26 dB @ DC to 4 GHz ≥ 20 dB @ 4 GHz to 18 GHz	
19 K 101-K20 D3	104599	1	standard	SMP female - female calibration adaptor	≥ 26 dB @ DC to 4 GHz ≥ 20 dB @ 4 GHz to 18 GHz	

Adaptors SMP - SMA

Rosenberger No.	Order No.	Sales Unit	Packaging	Remarks	
19 S 132-S00 S3	100585	1	standard	SMP male - SMA male	
19 S 132-K00 S3	101244	1	standard	SMP male - SMA female	
19 K 132-S00 D3	150878	1	standard	SMP female - SMA male	
19 K 132-K00 D3	105168	1	standard	SMP female - SMA female	

Adaptors SMP - RPC-2.92

Rosenberger No.	Order No.	Sales Unit	Packaging	Remarks	Return Loss	
02 S 119-S00 E3	106429	1	standard	RPC-2.92 male - SMP male	≥ 32 dB @ DC to 12 GHz ≥ 26 dB @ 12 GHz to 26.5 GHz ≥ 21 dB @ 26.5 GHz to 40 GHz	
02 S 119-K00 E3	104118	1	standard	RPC-2.92 male - SMP female	≥ 32 dB @ DC to 12 GHz ≥ 26 dB @ 12 GHz to 26.5 GHz ≥ 21 dB @ 26.5 GHz to 40 GHz	
02 K 119-S00 E3	101856	1	standard	RPC-2.92 female - SMP male	≥ 32 dB @ DC to 12 GHz ≥ 26 dB @ 12 GHz to 26.5 GHz ≥ 21 dB @ 26.5 GHz to 40 GHz	
02 K 119-K00 E3	106066	1	standard	RPC-2.92 female - SMP female	≥ 32 dB @ DC to 12 GHz ≥ 26 dB @ 12 GHz to 26.5 GHz ≥ 21 dB @ 26.5 GHz to 40 GHz	

Adaptors SMP - RPC-3.50

Rosenberger No.	Order No.	Sales Unit	Packaging	Remarks	Return Loss	
03 K 719-S22 S3	135504	1	standard	RPC-3.50 female - SMP male full detent 2-hole flange floating test adaptor	≥ 30 dB @ DC to 12 GHz ≥ 20 dB @ 12 GHz to 26.5 GHz	

Terminations

Termination Plug



Rosenberger No.	Order No.	Sales Unit	Packaging	Remarks	Return Loss	
19 S 15R-001 E4	135083	1	standard	1 Watt Frequency: DC to 18 GHz	≥ 28.3 dB @ DC to 1 GHz ≥ 20.1 dB @ 1 GHz to 18 GHz	

Termination Jack

Rosenberger No.	Order No.	Sales Unit	Packaging	Remarks	Return Loss	
19 K 15R-001 E4	103103	10	blister	1 Watt Frequency: DC to 18 GHz	≥ 28.3 dB @ DC to 1 GHz ≥ 20.1 dB @ 1 GHz to 18 GHz	

Special Tools

Extraction Tool

Rosenberger No.	Order No.	Sales Unit	Packaging	Remarks	
19 W 002-000	104203	1	standard	extraction tool for SMP connectors	
19 W 009-000	214301	1	box	extraction tool for SMP connectors	

Distance Gauge

Rosenberger No.	Order No.	Sales Unit	Packaging	Remarks	
11 W 115-000	150600	1	standard	distance gauge for SMP connectors width 0.6 mm, thickness 0.5 mm	

Longwipe-SMP

Interface Dimensions Longwipe-SMP

Code 17

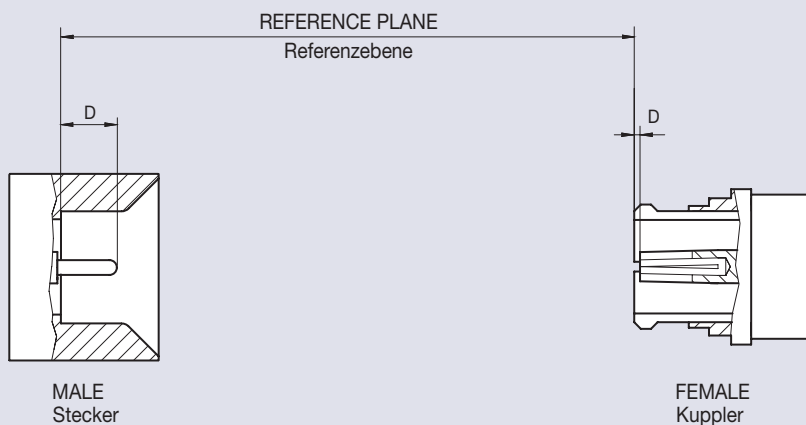

	Male Stecker		Female Kuppler	
	min.	max.	min.	max.
D	2.10	2.30	0.00	0.20

Dimensions in mm

Longwipe-SMP coaxial connectors are designed for applications up to 6 GHz and enable axial tolerance compensation of ± 0.7 mm. Limited detent as well as catchers mitt types - sliding contact with expanded guide-in range - are available.

Longwipe-SMP-Steckverbinder sind für Anwendungen bis 6 GHz konzipiert und ermöglichen einen axialen Toleranzausgleich von ± 0.7 mm. Longwipe-SMP-Stecker werden als Limited detent- und Catchers mitt-Typen - gleitender Kontakt mit erweitertem Fangbereich - angeboten.

Features

- ▶ Interface according to Rosenberger Longwipe-SMP series
- ▶ Frequency range DC to 6 GHz
- ▶ Return loss (cable connector straight) ≥ 23 dB (typ.)
- ▶ Impedance 50Ω
- ▶ Minimum board-to-board distance ≥ 9.25 mm
- ▶ Snap-on coupling

Product Range

- ▶ PCB connectors
- ▶ Adaptors

Technical Data Longwipe-SMP

Code 17

Applicable standards Anwendbare Normen	
Interface according to Interface gemäß	Rosenberger Longwipe-SMP
Electrical data Elektrische Daten	
Impedance Wellenwiderstand	50 Ω
Frequency range Frequenzbereich	DC to 6 GHz
Return loss (cable connector straight) Rückflussdämpfung (Kabelsteckverbinder gerade)	≥ 23 dB (typ.)
Insertion loss Dämpfung	≤ 0.1 × √f (GHz) dB
Insulation resistance Isolationswiderstand	≥ 5 GΩ
Center contact resistance Übergangswiderstand Innenleiter	≤ 6 mΩ
Outer contact resistance Übergangswiderstand Außenleiter	≤ 2 mΩ
Test voltage Prüfspannung	500 V rms
Working voltage Betriebsspannung	335 V rms
Power handling Leistungsbelastbarkeit	100 W @ 2.2 GHz
Contact current Kontaktstrombelastbarkeit	≤ 1.2 A DC
RF leakage - Interface Schirmdämpfung	≥ 85 dB @ DC to 4 GHz
Intermodulation 3rd order Intermodulation 3. Ordnung	≤ -150 dBc (2 x 43 dBm)
Mechanical data Mechanische Daten	
Mating cycles Steckzyklen	Full detent: ≥ 100 Limited detent: ≥ 500 Smooth bore, Catchers mitt: ≥ 1000
Center contact captivation Innenleiter Haltekraft	axial: ≥ 7 N
Engagement force Steckkraft	Full detent: ≤ 68 N Limited detent: ≤ 45 N Smooth bore, Catchers mitt: ≤ 9 N
Disengagement force Ziehkraft	Full detent: ≥ 22 N Limited detent: ≥ 9 N Smooth bore, Catchers mitt: ≥ 2.2 N
Axial misalignment Axialer Toleranzausgleich	± 0.7 mm
Radial misalignment Radialer Toleranzausgleich	4° (interface)
Board-to-board distance (min.) Board-to-board Abstand (min.)	9.25 mm (solder paste thickness not included)
Environmental data Umweltdaten	
Temperature range Temperaturbereich	-65 °C to +155 °C
Thermal shock Temperaturzyklen	MIL-STD-202, Method 107, Condition B
Damp heat Feuchte Wärme	IEC 60068-2-78 (40 °C, 93% RH, 56d)
Climatic category Klimakategorie	IEC 61169-1, Sub-clause 9.4.5 (+155 °C, 250 hours)
Moisture resistance Feuchtigkeitsbeständigkeit	MIL-STD-202, Method 106
Vibration Vibration	MIL-STD-202, Method 204, Condition B
Shock Schock	MIL-STD-202, Method 213, Condition A
Max. soldering temperature (PCB connectors) Max. Löttemperatur (Leiterplattensteckverbinder)	IEC 61760-1, +260 °C for 10 sec.
Materials Materialien	
Spring loaded contact parts Federnde Kontaktteile	CuBe, Au plating
Center contact Innenleiter	CuZn, Au plating
Outer contact Außenleiter	CuZn, Au plating
Crimping ferrule Crimphülse	Cu, Au plating
Dielectric Dielektrikum	PTFE / PEEK / LCP



Rosenberger connectors generally fulfill the indicated technical data. Individual values of connectors may deviate depending upon application, design, type of cable, assembly method and workmanship. Data sheets for particular products can be downloaded on our website or can be provided on request from your Rosenberger sales partner.

Rosenberger-Steckverbinder erfüllen grundsätzlich die hier angegebenen technischen Daten. Je nach Anwendung, Bauart, Kabeltyp, Montageart und -ausführung können einzelne Werte der Steckverbinder hiervon abweichen. Datenblätter zu einzelnen Produkten können Sie von unserer Website herunterladen oder auf Anfrage von Ihrem Rosenberger-Ansprechpartner erhalten.

PCB Connectors - SMD



Straight Plug

SMD

Rosenberger No.	Order No.	Sales Unit	Packaging	Remarks	
17 S 101-40M L5	222745	1500	tape & reel	Limited detent	
	210135	100	blister		
17 S 144-40M L5	257830	750	tape & reel	Catchers mitt	
	180773	100	blister		
17 S 14F-40M L5	264730	100	blister	Catchers mitt - catch diameter Ø6.8mm removable plastic cap on suction area	
17 S 145-40M L5	249405	500	tape & reel	Catchers mitt pin-in-paste removable plastic cap on suction area	
	192342	100	blister		

Right Angle Plug

SMD

Rosenberger No.	Order No.	Sales Unit	Packaging	Remarks	
17 S 201-40M L5	171463	100	blister	Smooth bore	
17 S 202-40M L5	238727	100	blister	Limited detent	
17 S 244-40M L5	267642	100	blister	Smooth bore	

PCB Connectors - Press fit

Straight Plug

Press fit

Rosenberger No.	Order No.	Sales Unit	Packaging	Remarks	
17 S 14A-40P L5	209480	100	blister	Catchers mitt	

PCB Connectors - Solder Pin

Straight Plug

Solder Pin

Rosenberger No.	Order No.	Sales Unit	Packaging	Remarks	
17 S 14D-400 L5	285547	100	blister	Catchers mitt pin-in-paste	

Adaptors

Bullets Longwipe-SMP female-female

Rosenberger No.	Order No.	Sales Unit	Packaging	Board-to-Board Distance ^{1) 3)}	Bullet Length ²⁾	
17 K 117-K02 L5	207655	100	standard	9.95 mm ± 0.7mm	6.65 mm	
17 K 117-K01 L5	207654	100	standard	14.00 mm ± 0.7mm	10.70 mm	
17 K 117-K03 L5	211312	100	standard	24.30 mm ± 0.7mm	21.00 mm	
17 K 117-K04 L5	211313	100	standard	40.00 mm ± 0.7mm	36.70 mm	

1) When standard SMD-connectors are applied (e.g. 17 S 101-40M, 17 S 144-40M, ...).

2) Bullets with other lengths on request.

3) Solder paste thickness not included.

Adaptors Longwipe-SMP - SMA

Rosenberger No.	Order No.	Sales Unit	Packaging	Remarks	Return Loss	
17 K 732-K0A S5	243229	1	standard	Longwipe-SMP female - SMA female 2-hole flange	≥ 23 dB @ DC to 3 GHz ≥ 20 dB @ 3 GHz to 6 GHz	

Adaptors Longwipe-SMP - RPC-3.50

Rosenberger No.	Order No.	Sales Unit	Packaging	Remarks	Return Loss	
03 K 717-S22 S5	188532	1	standard	RPC-3.50 female - Long- wipe-SMP male 2-hole flange floating test adaptor	≥ 30 dB @ DC to 2.5 GHz ≥ 25 dB @ 2.5 GHz to 6 GHz	

Interface Dimensions Mini-SMP

Code 18

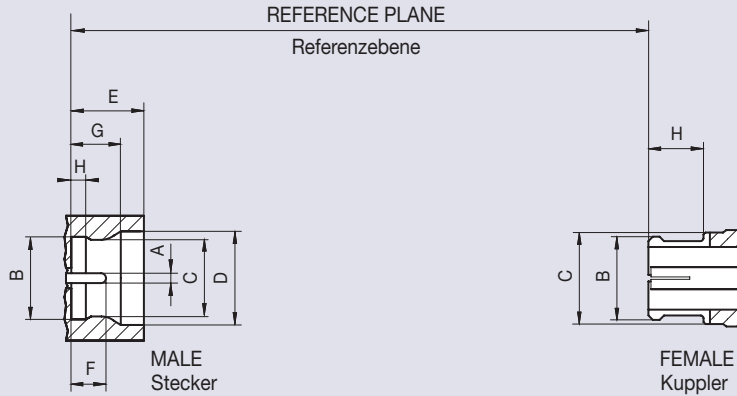

	Male Stecker				Female Kuppler	
	Smooth bore min.	max.	Full detent min.	max.	min.	max.
A	Ø 0.28	Ø 0.33	Ø 0.28	Ø 0.33	–	–
B	Ø 2.18	Ø 2.24	Ø 2.18	Ø 2.24	–	Ø 2.41 ¹⁾
C	–	–	Ø 2.11	Ø 2.16	–	Ø 2.79
D	Ø 2.82	Ø 2.92	Ø 2.82	Ø 2.92	–	–
E	2.08	2.13	2.08	2.13	–	–
F	0.76	1.14	0.76	1.14	–	–
G	–	–	1.57	1.83	–	–
H	–	–	0.53	0.58	1.73	–

Dimensions in mm

¹⁾ Resilient, dimension to meet electrical and mechanical requirements

Mini-SMP connectors are extremely small coaxial connectors - approx. 70% of SMP size - for applications up to 65 GHz, mainly high-speed signal transmission, e.g. 10 or 40 Gbit/s. Plugs are available as smooth bore-versions - for plug-in technology and back plane applications - and as vibration-resistant full detent types for highest mechanical loads, e.g. in aerospace engineering.

Mini-SMP coaxial connectors are mateable with GPPO™ (Gilbert Engineering Co., Inc.) and SSMP™ (Carlisle Interconnect Technologies) series. PCB connectors are supplied in tape & reel packaging.

Mini-SMP-Steckverbinder sind extrem kleine Koaxial-Steckverbinder - 70% Baugröße im Vergleich zu SMP - für Anwendungen bis 65 GHz. Hauptanwendung ist die Übertragung von Hochgeschwindigkeitssignalen, z. B. bei 10 oder 40 Gbit/s. Stecker werden als Smooth bore-Ausführung - für Einschubtechnik- und "Back Plane"-Anwendungen - und als vibrationsstabile Full detent-Bauformen für höchste mechanische Beanspruchungen, z.B. in Luft- und Raumfahrt, angeboten.

Mini-SMP-Koaxial-Steckverbinder sind steckkompatibel mit den Steckverbinder-Serien GPPO™ (Gilbert Engineering Co., Inc.) und SSMP™ (Carlisle Interconnect Technologies), PCB-Steckverbinder werden in Blistergurt-Verpackungen ausgeliefert.

Features

- ▶ Interface according to US MIL-STD 348A, Fig. 328
- ▶ Frequency range DC to 65 GHz
- ▶ Return loss (cable connector straight) ≥ 26 dB @ DC to 26.5 GHz
- ▶ Impedance 50 Ω
- ▶ Minimum board-to-board distance ≥ 7.94 mm
- ▶ Snap-on coupling

Product Range

- ▶ Cable connectors
- ▶ PCB connectors
- ▶ Panel connectors
- ▶ Adaptors
- ▶ Terminations

Technical Data Mini-SMP

Code 18

Applicable standards Anwendbare Normen	
Interface according to Interface gemäß	MIL-STD-348A, Fig. 328 Mateable with GPPO™ (Gilbert Engineering Co., Inc) and SSMP™ (Carlisle Interconnect Technologies)
Electrical data Elektrische Daten	
Impedance Wellenwiderstand	50 Ω
Frequency range Frequenzbereich	DC to 65 GHz
Return loss (cable connector straight) Rückflusdämpfung (Kabelsteckverbinder gerade)	≥ 26 dB @ DC to 26.5 GHz ≥ 17 dB @ 26.5 GHz to 50 GHz ≥ 14 dB @ 50 GHz to 65 GHz
Insertion loss Dämpfung	≤ 0.1 × √f (GHz) dB
Insulation resistance Isolationswiderstand	≥ 5 GΩ
Center contact resistance Übergangswiderstand Innenleiter	≤ 6 mΩ
Outer contact resistance Übergangswiderstand Außenleiter	≤ 2 mΩ
Working voltage Betriebsspannung	325 V rms
Power handling Leistungsbelastbarkeit	50 W @ 2.2 GHz
RF leakage - Interface Schirmdämpfung	≥ 85 dB @ DC to 4 GHz
Mechanical data Mechanische Daten	
Mating cycles Steckzyklen	Full detent: ≥ 100 Smooth bore: ≥ 500
Center contact captivation Innenleiter Haltekraft	axial: ≥ 7 N
Engagement force Steckkraft	Full detent: 19 N typical Smooth bore: 11 N typical
Disengagement force Ziehkraft	Full detent: 29 N typical Smooth bore: 7 N typical
Axial misalignment Axialer Toleranzausgleich	± 0.1 mm
Radial misalignment Radialer Toleranzausgleich	4° (interface)
Board-to-board distance (min.) Board-to-board Abstand (min.)	7.94 mm (solder paste thickness not included)
Environmental data Umweltdaten	
Temperature range Temperaturbereich	-55 °C to +155 °C
Thermal shock Temperaturzyklen	MIL-STD-202, Method 107, Condition B
Climatic category Klimakategorie	IEC 60068-2-1 55/155/21
Moisture resistance Feuchtigkeitsbeständigkeit	MIL-STD-202, Method 106
Vibration Vibration	MIL-STD-202, Method 204, Condition B
Shock Schock	MIL-STD-202, Method 213, Condition A
Max. soldering temperature (PCB connectors) Max. Löttemperatur (Leiterplattensteckverbinder)	IEC 61760-1, +260 °C for 10 sec.
Materials Materialien	
Spring loaded contact parts Federnde Kontaktteile	CuBe, Au plating
Center contact Innenleiter	CuZn / CuBe, Au plating
Outer contact Außenleiter	CuZn / CuBe, Au plating
Crimping ferrule Crimphülse	Cu, Au plating
Dielectric Dielektrikum	PTFE



Rosenberger connectors generally fulfill the indicated technical data. Individual values of connectors may deviate depending upon application, design, type of cable, assembly method and workmanship. Data sheets for particular products can be downloaded on our website or can be provided on request from your Rosenberger sales partner.

Rosenberger-Steckverbinder erfüllen grundsätzlich die hier angegebenen technischen Daten. Je nach Anwendung, Bauart, Kabeltyp, Montageart und -ausführung können einzelne Werte der Steckverbinder hiervon abweichen. Datenblätter zu einzelnen Produkten können Sie von unserer Website herunterladen oder auf Anfrage von Ihrem Rosenberger-Ansprechpartner erhalten.

Cable Connectors Semi-Rigid Cables



Straight Jack

Semi-Rigid Cables

Rosenberger No.	Order No.	Sales Unit	Packaging	Cable Group	
18 K 101-270 L5	186729	100	standard	70	
18 K 102-271 L5	186747	100	standard	71	

Right Angle Jack

Semi-Rigid Cables

Rosenberger No.	Order No.	Sales Unit	Packaging	Cable Group	
18 K 203-270 L5	272604	100	standard	70	
18 K 202-270 L5	186761	100	standard	70	
18 K 201-271 L5	186751	100	standard	71	

Cable Connectors - Flexible Cables

Right Angle Jack, solder crimp



Flexible Cables

Rosenberger No.	Order No.	Sales Unit	Packaging	Cable Group	
18 K 201-301 L5	186759	100	standard	01	

Panel Connectors - Coaxial End

Panel Plug



Coaxial End

Rosenberger No.	Order No.	Sales Unit	Packaging	Remarks	
18 S 103-500 L5	167981	100	blister	Full detent	
18 S 101-5H0 E4	142498	50	blister	Full detent hermetic sealed	

PCB Connectors - SMD

Straight Plug

SMD

Rosenberger No.	Order No.	Sales Unit	Packaging	Remarks	
18 S 101-40M L5	187635	1500	tape & reel	Full detent	
	187629	100	blister	Frequency: DC to 26 GHz	
18 S 141-40M L5	189576	100	blister	Smooth bore Frequency: DC to 26 GHz	
18 S 102-40M L5	187657	1500	tape & reel	Full detent	
	184089	100	blister	Frequency: DC to 65 GHz	
18 S 142-40M L5	189577	100	blister	Smooth bore Frequency: DC to 65 GHz	
18 S 143-40M L5	189579	1500	tape & reel	Smooth bore Frequency: DC to 65 GHz removable plastic cap on suction area	

Right Angle Plug

SMD

Rosenberger No.	Order No.	Sales Unit	Packaging	Remarks	
18 S 203-40M L5	187669	2500	tape & reel	Full detent Frequency: DC to 26.5 GHz	
	187662	100	blister		
18 S 243-40M L5	189581	100	blister	Smooth bore Frequency: DC to 26.5 GHz	
18 S 20G-40M L5	183922	100	blister	Full detent 2 channel	
18 S 24G-40M L5	216533	1250	tape & reel	Smooth bore 2 channel	
	201179	100	blister		
18 S 20H-40M L5	183925	100	blister	Full detent 4 channel	
18 S 24H-40M L5	225658	1250	tape & reel	Smooth bore 4 channel	
	197929	100	blister		

Adaptors

Bullets Mini-SMP female-female

Rosenberger No.	Order No.	Sales Unit	Packaging	Board-to-Board Distance ^{1) 3)}	Bullet Length ²⁾	
18 K 101-K00 L5	186745	100	standard	8.04 mm \pm 0.1 mm	5.30 mm	
18 K 118-K04 L5	191786	250	standard	10.11 mm \pm 0.1 mm	7.37 mm	
18 K 104-K00 L5	191782	500	blister	11.22 mm \pm 0.1 mm	8.48 mm	
18 K 107-K00 L5	191785	200	standard	13.73 mm \pm 0.1 mm	10.97 mm	

1) When standard SMD-connectors are applied (e.g. 18 S 101-40M, 18 S 141-40M).

2) Bullets with other lengths on request.

3) Solder paste thickness not included.

Adaptors Mini-SMP - RPC-1.85

Rosenberger No.	Order No.	Sales Unit	Packaging	Remarks	Return Loss	
08 S 118-S00 S3	107984	1	standard	RPC-1.85 male - Mini-SMP male	≥ 30 dB @ DC to 12 GHz ≥ 18 dB @ 12 GHz to 50 GHz ≥ 15 dB @ 50 GHz to 65 GHz	
08 S 118-K00 S3	102920	1	standard	RPC-1.85 male - Mini-SMP female	≥ 30 dB @ DC to 12 GHz ≥ 18 dB @ 12 GHz to 50 GHz ≥ 15 dB @ 50 GHz to 65 GHz	
08 K 118-S00 S3	102024	1	standard	RPC-1.85 female - Mini-SMP male	≥ 30 dB @ DC to 12 GHz ≥ 18 dB @ 12 GHz to 50 GHz ≥ 15 dB @ 50 GHz to 65 GHz	
08 K 118-K00 S3	101442	1	standard	RPC-1.85 female - Mini-SMP female	≥ 30 dB @ DC to 12 GHz ≥ 18 dB @ 12 GHz to 50 GHz ≥ 15 dB @ 50 GHz to 65 GHz	

Adaptors Mini-SMP - RPC-2.92

Rosenberger No.	Order No.	Sales Unit	Packaging	Remarks	Return Loss	
02 S 118-S00 S3	103523	1	standard	RPC-2.92 male - Mini-SMP male	≥ 30 dB @ DC to 12 GHz ≥ 26 dB @ 12 GHz to 20 GHz ≥ 18 dB @ 20 GHz to 40 GHz	
02 S 118-K00 S3	100430	1	standard	RPC-2.92 male - Mini-SMP female	≥ 30 dB @ DC to 12 GHz ≥ 26 dB @ 12 GHz to 20 GHz ≥ 18 dB @ 20 GHz to 40 GHz	
02 K 118-S00 S3	104402	1	standard	RPC-2.92 female - Mini-SMP male	≥ 30 dB @ DC to 12 GHz ≥ 26 dB @ 12 GHz to 20 GHz ≥ 18 dB @ 20 GHz to 40 GHz	
02 K 118-K00 S3	103749	1	standard	RPC-2.92 female - Mini-SMP female	≥ 30 dB @ DC to 12 GHz ≥ 26 dB @ 12 GHz to 20 GHz ≥ 18 dB @ 20 GHz to 40 GHz	

Terminations

Termination Plug

Rosenberger No.	Order No.	Sales Unit	Packaging	Remarks	Return Loss	
18 S 15R-0.5 E3	154731	1	standard	0.5 Watt Frequency: DC to 40 GHz	≥ 26.4 dB @ DC to 18 GHz ≥ 17.7 dB @ 18 GHz to 26.5 GHz ≥ 16.6 dB @ 26.5 GHz to 40 GHz	

Termination Jack

Rosenberger No.	Order No.	Sales Unit	Packaging	Remarks	Return Loss	
18 K 15R-0.5 E3	139130	1	standard	0.5 Watt Frequency: DC to 40 GHz	≥ 26.4 dB @ DC to 18 GHz ≥ 17.7 dB @ 18 GHz to 26.5 GHz ≥ 16.6 dB @ 26.5 GHz to 40 GHz	

Special Tools

Extraction Tool

Rosenberger No.	Order No.	Sales Unit	Packaging	Remarks	
18 W 002-000	147669	1	standard	extraction tool for Mini-SMP connectors	

FMC



The extremely small FMC connector series – Flexible Microstrip Connectors – are designed for PCB applications in the tightest spaces. Using ‘bullets’, equalization of radial and axial misalignments in board-to-board connections are possible.

Compared to SMP connectors, the innovative FMC interface design allows significantly more misalignment whilst maintaining constant electrical characteristics over the whole length of the connection.

PCB connectors are available as limited detent or smooth bore types.

Die Rosenberger-Serie FMC – Flexible Microstrip Connectors – verfügt über extrem kleine Abmessungen und eignet sich hervorragend für Leiterplattenanwendungen auf engstem Raum. Durch Einsatz sogenannter Bullets sind sowohl radialer als auch axialer Toleranzausgleich bei Board-to-Board-Verbindungen möglich. Im Vergleich zu SMP-Steckverbindern ist aufgrund des Interface-Designs deutlich mehr Toleranzausgleich möglich - bei gleichbleibenden elektrischen Eigenschaften über die gesamte Länge der Steckverbindung. PCB-Typen sind in Limited detent- und Smooth bore-Ausführungen erhältlich.

FMC

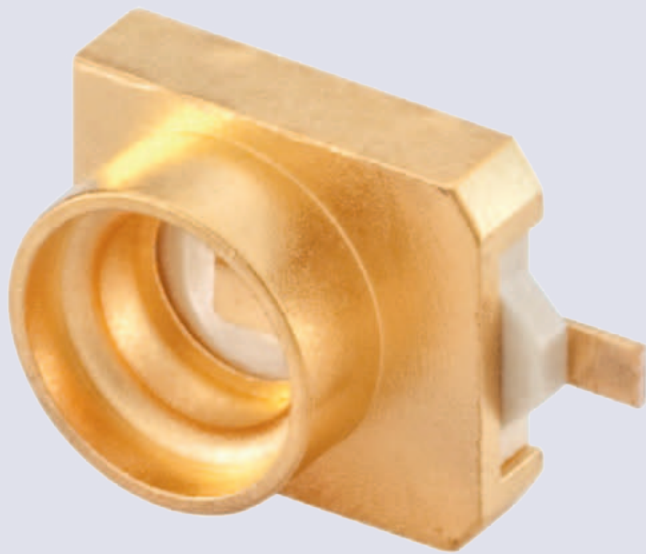

Interface Dimensions FMC

Code 16

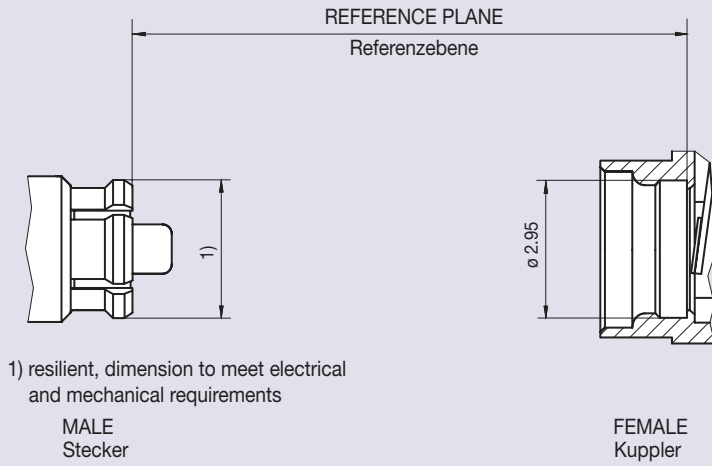

Features

- ▶ Interface according to Rosenberger FMC
- ▶ Frequency range DC to 10 GHz
- ▶ Return loss (cable connector straight) ≥ 23 dB (typ.)
- ▶ Impedance 50Ω
- ▶ Minimum board-to-board distance ≥ 6.05 mm
- ▶ Snap-on coupling

Product Range

- ▶ Cable connectors
- ▶ PCB connectors (SMD versions)
- ▶ Adaptors

Technical Data FMC

Code 16

Applicable standards Anwendbare Normen	
Interface according to Interface gemäß	Rosenberger FMC
Electrical data Elektrische Daten	
Impedance Wellenwiderstand	50 Ω
Frequency range Frequenzbereich	DC to 10 GHz
Return loss (cable connector straight) Rückflusdämpfung (Kabelsteckverbinder gerade)	≥ 23 dB (typ.)
Insertion loss Dämpfung	≤ 0.1 × √f (GHz) dB
Insulation resistance Isolationswiderstand	≥ 5 GΩ
Center contact resistance Übergangswiderstand Innenleiter	≤ 6 mΩ
Outer contact resistance Übergangswiderstand Außenleiter	≤ 2 mΩ
Test voltage Prüfspannung	500 V rms
Working voltage Betriebsspannung	335 V rms
Power handling Leistungsbelastbarkeit	50 W @ 2.2 GHz
Contact current Kontaktstrombelastbarkeit	≤ 1.2 A DC
RF leakage - Interface Schirmdämpfung	≥ 80 dB @ DC to 3 GHz ≥ 65 dB @ 3 GHz to 10 GHz
Mechanical data Mechanische Daten	
Mating cycles Steckzyklen	≥ 100
Engagement force Steckkraft	Full detent: ≤ 68 N Limited detent: ≤ 45 N Smooth bore: ≤ 9 N
Disengagement force Ziehkraft	Full detent: ≥ 22 N Limited detent: ≥ 9 N Smooth bore: ≥ 2.2 N
Axial misalignment Axialer Toleranzausgleich	± 0.3 mm
Radial misalignment Radialer Toleranzausgleich	4°
Board-to-board distance (min.) Board-to-Board Abstand (min.)	6.05 mm (solder paste thickness not included)
Environmental data Umweltdaten	
Temperature range Temperaturbereich	-40 °C to +105 °C
Damp heat Feuchte Wärme	IEC 60169-1, Sub-clause 16.3
Mixed flowing gas Schadgas	DIN EN 60068-2-60, Method 4
Vibration Vibration	IEC 61169-1, Sub-clause 9.3.3
Shock Schock	IEC 60169-1, Sub-clause 15.8
Max. soldering temperature (PCB connectors) Max. Löttemperatur (Leiterplattensteckverbinder)	IEC 61760-1, +260 °C for 10 sec.
Materials Materialien	
Spring loaded contact parts Federnde Kontaktteile	CuBe, Au plating
Center contact Innenleiter	CuZn / CuBe, Au plating
Outer contact Außenleiter	CuZn / CuBe, Au plating
Dielectric Dielektrikum	PTFE / LCP

Rosenberger connectors generally fulfill the indicated technical data. Individual values of connectors may deviate depending upon application, design, type of cable, assembly method and workmanship. Data sheets for particular products can be downloaded on our website or can be provided on request from your Rosenberger sales partner.

Rosenberger-Steckverbinder erfüllen grundsätzlich die hier angegebenen technischen Daten. Je nach Anwendung, Bauart, Kabeltyp, Montageart und -ausführung können einzelne Werte der Steckverbinder hiervon abweichen. Datenblätter zu einzelnen Produkten können Sie von unserer Website herunterladen oder auf Anfrage von Ihrem Rosenberger-Ansprechpartner erhalten.

Cable Connectors - Semi-Rigid Cables

Right Angle Plug, solder

Semi-Rigid Cables

Rosenberger No.	Order No.	Sales Unit	Packaging	Cable Group	
16 S 201-270 L5	154642	25	standard	70	
16 S 201-271 L5	154643	25	standard	71	

PCB Connectors - SMD

Straight Jack, PCB with spring contact

SMD

Rosenberger No.	Order No.	Sales Unit	Packaging	Remarks	
16 P 101-40M L4	154638	100	blister	Limited detent	
16 P 141-40M L4	154639	100	blister	Smooth bore	

Adaptors

Bullets FMC male-male

Rosenberger No.	Order No.	Sales Unit	Packaging	Board-to-Board Distance ^{1) 3)}	Bullet Length ²⁾	
16 S 101-S00 L5	154637	100	standard	6.35 mm ± 0.3 mm	5.50 mm	
16 S 102-S00 L5	156302	100	standard	10.35 mm ± 0.3 mm	9.50 mm	

- 1) When standard FMC-connectors are applied (e.g. 16 P 101-40M, 16 P 141-40M).
- 2) Bullets with other lengths on request.
- 3) Solder paste thickness not included.

Adaptors FMC - SMA

Rosenberger No.	Order No.	Sales Unit	Packaging	Remarks	
16 S 132-K00 L5	163582	5	standard	FMC male - SMA female	

MCX 50 Ω



MCX coaxial connectors, provided with a snap-on coupling mechanism, are mainly applied in RF cable connections up to 6 GHz, e.g. in fixed and wireless communication systems. MCX connectors are characterized by high reliability, long service life, as well as easy and fast mounting.

MCX-Koaxial-Steckverbinder verfügen über eine Schnappverbindung und sind konzipiert für HF-Verkabelungen im Frequenzbereich bis 6 GHz, u.a. in Anwendungen in den Bereichen Festnetz-Telekommunikation und Mobilfunkanlagen. Vorteile von MCX-Steckverbindern sind hohe Zuverlässigkeit, lange Lebensdauer sowie einfache und schnelle Montierbarkeit.

MCX 50 Ω

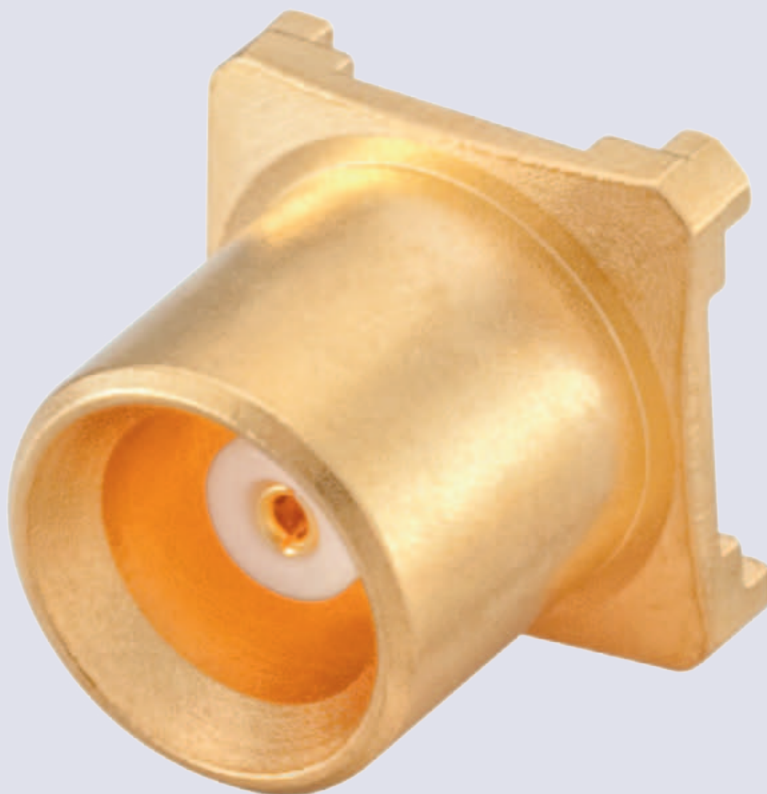

MCX 50 Ω

Interface Dimensions MCX 50 Ω

Code 29

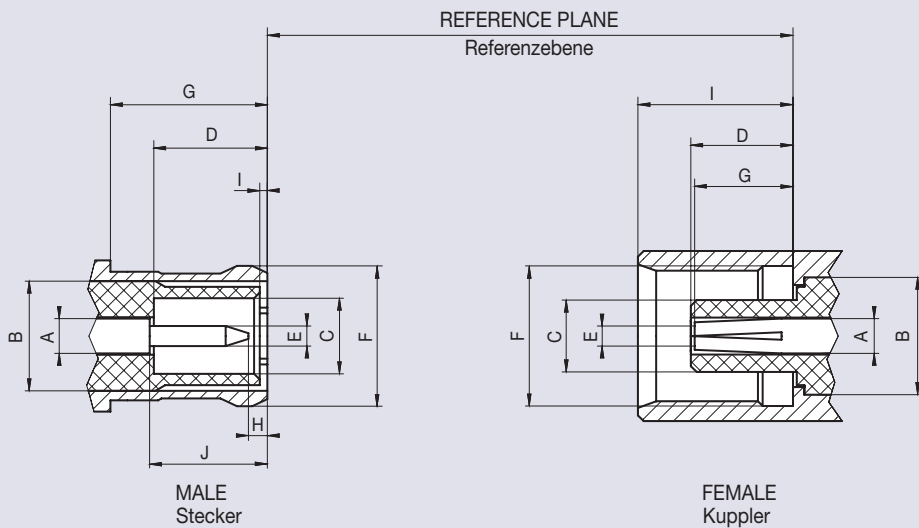

	Male Stecker		Female Kuppler	
	min.	max.	min.	max.
A	1)		1) 2)	
B	–	∅ 3.00 ²⁾	∅ 3.05 nom.	
C	∅ 2.00	–	–	∅ 1.98
D	2.80	–	2.60	2.80
E	∅ 0.48	∅ 0.53	2)	
F	–	∅ 3.80 ²⁾	∅ 3.60	∅ 3.75
G	4.15	–	2.30	2.80
H	0.15	–	–	–
I	0.00	0.30	4.00	4.12
J	2.80	3.20	–	–

Dimensions in mm

¹⁾ Contact diameter refers to 50 Ω

²⁾ Resilient, dimension to meet electrical and mechanical requirements

MCX connectors with 75 Ω characteristic impedance are available on request.

MCX Steckverbinder in 75 Ω sind auf Anfrage erhältlich.

Features

- ▶ Interface according to IEC 61169-36, CECC 22220
- ▶ Frequency range DC to 6 GHz
- ▶ Return loss (cable connector straight) ≥ 20 dB (typ.)
- ▶ Impedance 50 Ω
- ▶ 30% size reduction compared to SMB connectors
- ▶ Snap-on coupling

Product Range

- ▶ Cable connectors
- ▶ Panel connectors
- ▶ PCB connectors
- ▶ Terminations
- ▶ Adaptors

Technical Data MCX 50 Ω

Code 29

Applicable standards Anwendbare Normen	
Interface according to Interface gemäß	IEC 61169-36, CECC 22220
Electrical data Elektrische Daten	
Impedance Wellenwiderstand	50 Ω
Frequency range Frequenzbereich	DC to 6 GHz
Return loss (cable connector straight) Rückflussdämpfung (Kabelsteckverbinder gerade)	≥ 21 dB (typ.)
Insertion loss Dämpfung	≤ 0.1 × √f (GHz) dB
Insulation resistance Isolationswiderstand	≥ 1 GΩ
Center contact resistance Übergangswiderstand Innenleiter	≤ 5 mΩ
Outer contact resistance Übergangswiderstand Außenleiter	≤ 2.5 mΩ
Test voltage Prüfspannung	750 V rms
Working voltage Betriebsspannung	335 V rms
Contact current Kontaktstrombelastbarkeit	≤ 1.5 A DC
RF leakage - Interface Schirmdämpfung	≥ 70 dB @ DC to 1 GHz
Mechanical data Mechanische Daten	
Mating cycles Steckzyklen	≥ 500
Center contact captivation Innenleiter Haltekraft	axial: ≥ 10 N
Engagement force Steckkraft	≤ 25 N
Disengagement force Ziehkraft	8 N to 20 N
Environmental data Umweltdaten	
Temperature range Temperaturbereich	-55 °C to +155 °C
Thermal shock Temperaturzyklen	CECC 22220, Chapter 4.6.7
Damp heat Feuchte Wärme	CECC 22220, Chapter 4.6.6
Corrosion resistance Korrosionsbeständigkeit	CECC 22220, Chapter 4.6.10
Vibration Vibration	CECC 22220, Chapter 4.6.3
Max. soldering temperature (PCB connectors) Max. Löttemperatur (Leiterplattensteckverbinder)	IEC 61760-1, +260 °C for 10 sec.
Materials Materialien	
Spring loaded contact parts Federnde Kontaktteile	CuBe, Au plating
Center contact Innenleiter	CuZn, Au plating
Outer contact Außenleiter	CuZn, Au / white bronze plating
Crimping ferrule Crimphülse	Cu, Au / white bronze plating
Dielectric Dielektrikum	PTFE
Gasket Dichtung	Rubber

Rosenberger connectors generally fulfill the indicated technical data. Individual values of connectors may deviate depending upon application, design, type of cable, assembly method and workmanship. Data sheets for particular products can be downloaded on our website or can be provided on request from your Rosenberger sales partner.

Rosenberger-Steckverbinder erfüllen grundsätzlich die hier angegebenen technischen Daten. Je nach Anwendung, Bauart, Kabeltyp, Montageart und -ausführung können einzelne Werte der Steckverbinder hiervon abweichen. Datenblätter zu einzelnen Produkten können Sie von unserer Website herunterladen oder auf Anfrage von Ihrem Rosenberger-Ansprechpartner erhalten.

Cable Connectors Semi-Rigid Cables

Straight Plug, solder

Semi-Rigid Cables

Rosenberger No.	Order No.	Sales Unit	Packaging	Cable Group	
29 S 111-271 L5	186500	100	standard	71	

Right Angle Plug, solder

Semi-Rigid Cables

Rosenberger No.	Order No.	Sales Unit	Packaging	Cable Group	
29 S 211-271 L5	195003	100	standard	71	

Cable Connectors - Flexible Cables

Straight Plug, crimp

Flexible Cables

Rosenberger No.	Order No.	Sales Unit	Packaging	Cable Group	
29 S 111-101 L5	187219	100	standard	01	
29 S 111-102 L5	170219	100	standard	02	
29 S 111-103 L5	187218	100	standard	03	

Right Angle Plug, solder-crimp

Flexible Cables

Rosenberger No.	Order No.	Sales Unit	Packaging	Cable Group	
29 S 211-301 L5	195718	50	standard	01	
29 S 211-302 L5	183820	100	standard	02	
29 S 211-303 L5	197829	100	standard	03	

Panel Connectors - Coaxial End

Panel Jack, round flange

Coaxial End

Rosenberger No.	Order No.	Sales Unit	Packaging	Remarks	
29 K 501-500 L5	182267	100	blister	round flange	

MCX

PCB Connectors - SMD

Straight Jack, PCB

SMD

Rosenberger No.	Order No.	Sales Unit	Packaging	Remarks	
29 K 101-40M L5	162788	750	tape & reel	removable plastic cap on suction area	
	182262	100	blister		

Right Angle Jack, PCB

SMD

Rosenberger No.	Order No.	Sales Unit	Packaging	Remarks	
29 K 203-40M L5	182266	50	blister		

Straight/Right Angle Jack, PCB



SMD

Rosenberger No.	Order No.	Sales Unit	Packaging	Remarks	
29 K 10A-40M L5	182268	500	tape & reel	application as straight type removable plastic cap on suction area	
29 K 201-40M L5	181393	1500	tape & reel	application as right angle type without removable plastic cap on suction area	
	182271	100	blister		

PCB Connectors - Solder Pin

Straight Jack, PCB

Solder Pin

Rosenberger No.	Order No.	Sales Unit	Packaging	Remarks	
29 K 101-400 L5	182261	100	standard	without stand-off	
29 K 102-400 L5	163762	50	standard	stand-off version	

Right Angle Jack, PCB

Solder Pin

Rosenberger No.	Order No.	Sales Unit	Packaging	Remarks	
29 K 203-400 L5	169607	100	blister		

Adaptors

Adaptors MCX - SMA

Rosenberger No.	Order No.	Sales Unit	Packaging	Remarks	
29 S 132-K01 N5	151696	1	standard	MCX male - SMA female hexagonal flange	

Adaptors MCX - N 50 Ω

Rosenberger No.	Order No.	Sales Unit	Packaging	Remarks	
29 S 153-S00 Z5	102471	1	standard	MCX male - N male	
29 S 153-K00 Z5	100499	1	standard	MCX male - N female	
29 K 153-S00 Z5	104497	1	standard	MCX female - N male	
29 K 153-K00 Z5	101934	1	standard	MCX female - N female	

Terminations

Termination Plug

Rosenberger No.	Order No.	Sales Unit	Packaging	Remarks	Return Loss	
29 S 15R-1.0 E3	105913	100	standard	1 Watt Frequency: DC to 6 GHz	≥ 23.1 dB @ DC to 4 GHz ≥ 17.7 dB @ 4 GHz to 6 GHz	

MCX connectors in 75 Ω version are available on request.

P-SMP



P-SMP coaxial connectors from Rosenberger combine the advantages of SMP connectors – minimum board-to-board spaces – and of SMA connectors – high performance and high power rating. Minimum board-to-board distances from 12.6 mm can be realized by using bullets of different lengths, yet P-SMP connectors are designed for high power loads and operate at frequencies up to 10 GHz.

P-SMP – Power SMP – RF coaxial connectors have been designed for applications up to 200 W @ 2.2 GHz continuous power, e.g. board-to-board connections in base stations, or board-to-cable connections in power amplifier filter units.

PCB connectors – SMD and also pin-in-paste types - are available as limited detent or smooth bore types.

P-SMP-Koaxial-Steckverbinder von Rosenberger verbinden die Vorteile der Serien SMP – geringstmögliche Leiterplattenabstände – und SMA – hohe Leistung – miteinander. Durch Verwendung von Bullets sind minimale Leiterplattenabstände ab 12,6 mm möglich, gleichzeitig sind P-SMP-Steckverbinder bei hohen Leistungen bis in einen hohen Frequenzbereich bis 10 GHz belastbar.

Die Serie P-SMP - Power SMP - ist konzipiert für Anwendungen, bei denen Dauerleistungen bis 200 W @ 2.2 GHz gefordert sind, z. B. Board-to-Board-Steckverbindungen in Basisstationen oder Übergänge von Leiterplatte auf Kabel in Leistungsverstärker-Filterverbindungen.

PCB-Typen – SMD- und Pin-in-paste-Bauformen – sind als Limited detent- und Smooth bore-Ausführungen erhältlich.

P-SMP

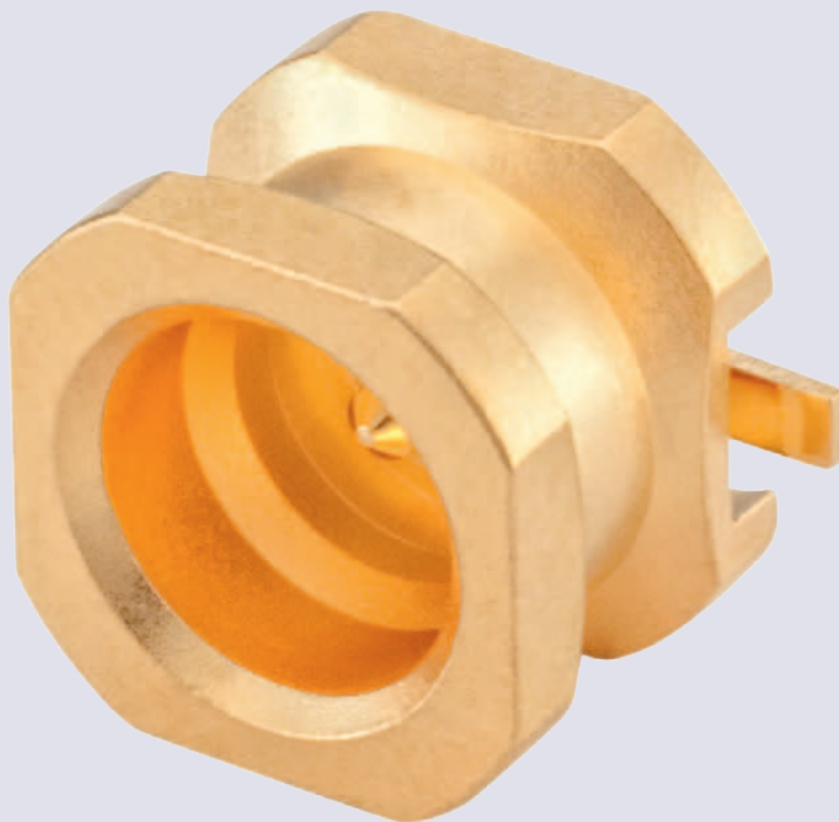

Interface Dimensions P-SMP

Code 119

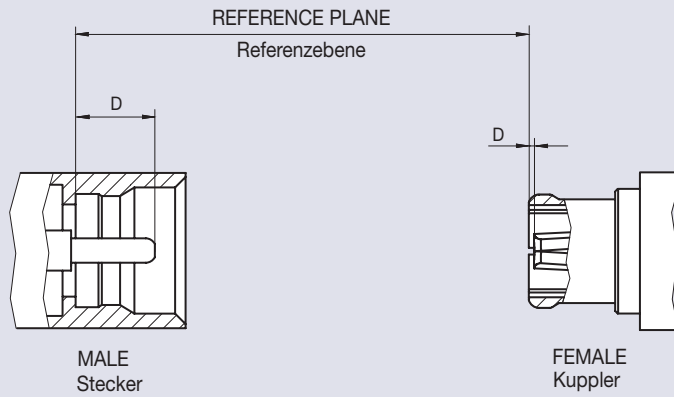

Dimensions in mm

D	Male Stecker				Female Kuppler	
	Smooth bore		Limited detent		min.	max.
	min.	max.	min.	max.		
	1.90	2.16	1.90	2.16	0.00	0.20

Features

- ▶ Interface according to Rosenberger P-SMP series
- ▶ Frequency range DC to 10 GHz
- ▶ Return loss (cable connector straight) ≥ 32 dB (typ.)
- ▶ Power handling (continuous) 200 W @ 2.2. GHz
- ▶ Impedance 50 Ω
- ▶ Minimum board-to-board distance ≥ 12.6 mm
- ▶ Axial misalignment ± 1 mm
- ▶ Radial misalignment 4°
- ▶ Snap-on coupling

Product Range

- ▶ Cable connectors
- ▶ Panel connectors
- ▶ PCB connectors (SMD versions)
- ▶ Adaptors

Technical Data P-SMP

Code 119

Applicable standards Anwendbare Normen	
Interface according to Interface gemäß	Rosenberger P-SMP
Electrical data Elektrische Daten	
Impedance Wellenwiderstand	50 Ω
Frequency range Frequenzbereich	DC to 10 GHz
Return loss (cable connector straight) Rückflusdämpfung (Kabelsteckverbinder gerade)	≥ 32 dB @ DC to 3 GHz ≥ 26 dB @ 3 GHz to 6 GHz
Insertion loss Dämpfung	≤ 0.03 x √f (GHz) dB
Insulation resistance Isolationswiderstand	≥ 5 GΩ
Center contact resistance Übergangswiderstand Innenleiter	≤ 3 mΩ
Outer contact resistance Übergangswiderstand Außenleiter	≤ 2 mΩ
Test voltage Prüfspannung	1000 V rms
Working voltage Betriebsspannung	480 V rms
Power handling Leistungsbelastbarkeit	200 W @ 2.2 GHz
Contact current Kontaktstrombelastbarkeit	≤ 15 A DC
RF leakage - Interface Schirmdämpfung	≥ 75 dB @ DC to 4 GHz
Intermodulation 3rd order Intermodulation 3. Ordnung	≤ -160 dBc (2 x 43 dBm)
Mechanical data Mechanische Daten	
Mating cycles Steckzyklen	Full detent: ≥ 100 Limited detent: ≥ 100 Smooth bore, Catchers mitt: ≥ 1000
Center contact captivation Innenleiter Haltekraft	axial: ≥ 7 N
Engagement force Steckkraft	Full detent: ≤ 68 N Limited detent: ≤ 45 N Smooth bore, Catchers mitt: ≤ 10 N
Disengagement force Ziehkraft	Full detent: ≥ 25 N Limited detent: ≥ 15 N Smooth bore, Catchers mitt: ≥ 2.2 N
Axial misalignment Axialer Toleranzausgleich	± 1 mm
Radial misalignment Radialer Toleranzausgleich	4°
Board-to-board distance (min.) Board-to-board Abstand (min.)	12.6 mm (solder paste thickness not included)
Environmental data Umweltdaten	
Temperature range Temperaturbereich	-65 °C to +165 °C
Thermal shock Temperaturzyklen	IEC 60169-1, Sub-clause 16.4 (-65 °C to +165 °C)
Climatic category Klimakategorie	IEC 60169-1, Sub-clause 18 (+165 °C, 1000 hours)
Vibration Vibration	IEC 60068-2-64 random
Shock Schock	IEC 60068-2-27 (50g, 11 ms, half-sine)
Max. soldering temperature (PCB connectors) Max. Löttemperatur (Leiterplattensteckverbinder)	IEC 61760-1, +260 °C for 10 sec.
Materials Materialien	
Spring loaded contact parts Federnde Kontaktteile	CuBe, Au / white bronze plating
Center contact Innenleiter	CuZn, Au plating
Outer contact Außenleiter	CuZn, Au / white bronze plating
Crimping ferrule Crimphülse	Cu, Au / white bronze plating
Dielectric Dielektrikum	PTFE / PEEK / LCP

Rosenberger connectors generally fulfill the indicated technical data. Individual values of connectors may deviate depending upon application, design, type of cable, assembly method and workmanship. Data sheets for particular products can be downloaded on our website or can be provided on request from your Rosenberger sales partner.

Rosenberger-Steckverbinder erfüllen grundsätzlich die hier angegebenen technischen Daten. Je nach Anwendung, Bauart, Kabeltyp, Montageart und -ausführung können einzelne Werte der Steckverbinder hiervon abweichen. Datenblätter zu einzelnen Produkten können Sie von unserer Website herunterladen oder auf Anfrage von Ihrem Rosenberger-Ansprechpartner erhalten.

Cable Connectors - Semi-Rigid Cables

Straight Jack, solder

Semi-Rigid Cables

Rosenberger No.	Order No.	Sales Unit	Packaging	Cable Group	
119 K 101-272 N5	209499	50	standard	72	

Right Angle Jack, solder

Semi-Rigid Cables

Rosenberger No.	Order No.	Sales Unit	Packaging	Cable Group	
119 K 207-272 N5	192163	50	standard	72	

Cable Connectors - Flexible Cables

Right Angle Jack, solder crimp

Flexible Cables

Rosenberger No.	Order No.	Sales Unit	Packaging	Cable Group	
119 K 207-303 N5	230112	100	standard	03	

Panel Connectors - Coaxial End

Panel Plug, hexagonal flange

Coaxial End

Rosenberger No.	Order No.	Sales Unit	Packaging	Remarks	
119 S 601-500 N5	211831	100	blister	Limited detent Panel feed through	
119 S 641-500 N5	192149	100	blister	Smooth bore Panel feed through	
119 S 64A-500 N5	226839	100	blister	Smooth bore Panel feed through	

P-SMP

PCB Connectors - SMD

Straight Plug, PCB

SMD

Rosenberger No.	Order No.	Sales Unit	Packaging	Remarks	
119 S 101-40M L5	203484	100	blister	Limited detent	
119 S 141-40M L5	208246	50	blister	Smooth bore	
119 S 104-40M L5	272600	1000	tape & reel	Limited detent	
	219742	100	blister		
119 S 144-40M L5	272603	1000	tape & reel	Smooth bore	
	222421	50	blister		
119 S 147-40M L5	235584	100	blister	Smooth bore	
119 S 102-40M L5	210504	50	blister	Limited detent pin-in-paste	
119 S 142-40M L5	211102	50	blister	Smooth bore pin-in-paste	
119 S 103-40M L5	234202	800	tape & reel	Limited detent pin-in-paste	
	211279	100	blister		
119 S 143-40M L5	216358	50	blister	Smooth bore pin-in-paste	
119 S 10B-40M L5	226203	100	blister	Limited detent pin-in-paste	
	283674	850	tape & reel		
119 S 14N-40M L5	277820	100	blister	Smooth bore pin-in-paste capture range Ø10.9 mm	
	283676	450	tape & reel		

Right Angle Plug, PCB

SMD

Rosenberger No.	Order No.	Sales Unit	Packaging	Remarks	
119 S 202-40M L5	208115	100	blister	Limited detent	
119 S 242-40M L5	209500	50	blister	Smooth bore	

P-SMP

PCB Connectors - Solder Pin

Straight Plug, PCB

Solder Pin

Rosenberger No.	Order No.	Sales Unit	Packaging	Remarks	
119 S 102-400 L5	219502	100	blister	Limited detent	

Adaptors

Bullets P-SMP female-female

Rosenberger No.	Order No.	Sales Unit	Packaging	Board-to-Board Distance ^{1) 3)}	Bullet Length ²⁾	
119 K 101-K00 N5	190567	100	standard	13.60 mm ± 1 mm	10.00 mm	
119 K 111-K00 N5	214907	100	standard	21.15 mm ± 1 mm	17.55 mm	
119 K 109-K00 N5	242900	100	standard	23.30 mm ± 1 mm	19.70 mm	
119 K 106-K00 N5	225967	100	standard	24.25 mm ± 1 mm	20.65 mm	
119 K 107-K00 N5	227162	100	standard	27.40 mm ± 1 mm	23.80 mm	
119 K 108-K00 N5	272599	50	standard	34.80 mm ± 1 mm	31.20 mm	
119 K 104-K00 N5	201517	50	standard	37.50 mm ± 1 mm	33.90 mm	
119 K 112-K00 N5	248549	100	standard	41.60 mm ± 1 mm	38.00 mm	

1) When standard SMD-connectors are applied (e.g. 119 S 101-400, 119 S 142-40M, ...).

2) Bullets with other lengths on request.

3) Solder paste thickness not included.

Adaptors P-SMP - RPC-3.50

Rosenberger No.	Order No.	Sales Unit	Packaging	Remarks	Return Loss	
03 K 719-S60 S3	223497	1	standard	RPC-3.50 female - P-SMP male full detent 2-hole flange floating test adaptor	≥ 35 dB @ DC to 4 GHz ≥ 26 dB @ 4 GHz to 10 GHz	

Adaptors P-SMP - SMA

Rosenberger No.	Order No.	Sales Unit	Packaging	Remarks	Return Loss	
119 S 132-S00 S5	197285	1	standard	P-SMP male - SMA male		
119 S 132-K00 S5	210521	1	standard	P-SMP male - SMA female		
119 K 132-S00 L5	197683	1	standard	P-SMP female - SMA male		
119 K 132-K00 L5	210505	1	standard	P-SMP female - SMA female		
119 K 732-K0B S5	226655	1	standard	P-SMP female - SMA female 2-hole flange floating test adaptor	≥ 38 dB @ DC to 3 GHz ≥ 30 dB @ 3 GHz to 6 GHz	

Adaptors P-SMP - N 50 Ω

Rosenberger No.	Order No.	Sales Unit	Packaging	Remarks	
119 K 153-K00 L5	210513	1	standard	P-SMP female - N female	

SMA



SMA coaxial connectors are high quality screw-on coupling connectors with defined maximum torque and feature high reliability, long service life, high mechanical stability and excellent electrical characteristics, in particular high return loss. SMA connectors can be applied in various RF applications up to 18 GHz, e.g. telecommunication and mobile communication, test & measurement equipment and instruments.

SMA-Koaxial-Steckverbinder sind qualitativ hochwertige Schraubsteckverbinder mit definiertem Anzugsdrehmoment und zeichnen sich aus durch höchstmögliche Zuverlässigkeit, hohe mechanische Stabilität, lange Lebensdauer und hervorragende elektrische Eigenschaften, insbesondere hohe Rückflussdämpfung. SMA-Steckverbinder sind bis in einen Frequenzbereich bis 18 GHz äußerst vielseitig einsetzbar, z. B. in der Telekommunikation, im Mobilfunk oder in der industriellen Messtechnik.

SMA

SMA



Interface Dimensions SMA

Code 32

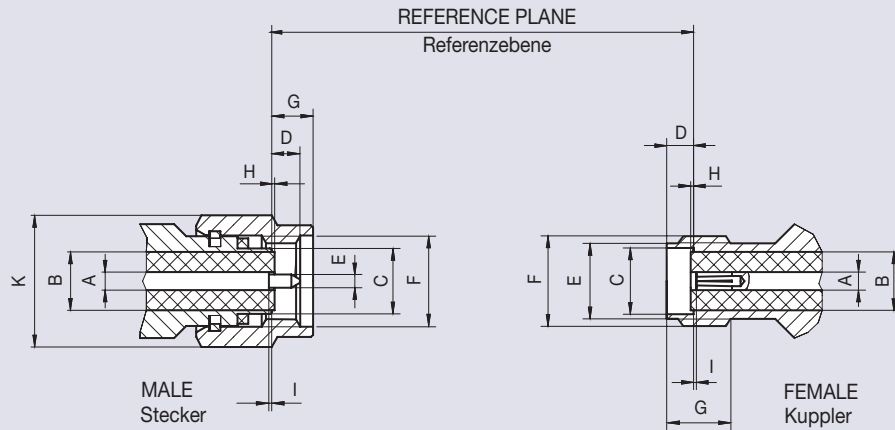

	Male Stecker		Female Kuppler	
	min.	max.	min.	max.
A	Ø 1.245	Ø 1.295	Ø 1.245	Ø 1.295 ¹⁾
B	–	Ø 4.178	–	Ø 4.178
C	–	Ø 4.59	Ø 4.60	Ø 4.67
D	–	2.54	1.88	1.98
E	Ø 0.902	Ø 0.940	Ø 5.28	Ø 5.49
F	1/4-36 UNS-2B		1/4-36 UNS-2A	
G	–	3.43	4.32	–
H	-0.18	+0.05	-0.18	+0.05
I	0.00	–	0.00	0.41
K	hex 8		–	–

Dimensions in mm

¹⁾Contact diameter refers to 50 Ω

Features

- ▶ Interface according to IEC 60169-15, EN 122110, MIL-STD-348A, Fig. 310
- ▶ Frequency range DC to 18 GHz
- ▶ Return loss (cable connector straight) ≥ 30 dB (typ.)
- ▶ Impedance 50 Ω
- ▶ Screw-on coupling

Product Range

- ▶ Cable connectors
- ▶ PCB connectors
- ▶ Panel connectors
- ▶ Hermetically sealed versions
- ▶ Adaptors
- ▶ Terminations
- ▶ Tools and Accessories

Technical Data SMA

Code 32

Applicable standards Anwendbare Normen	
Interface according to Interface gemäß	IEC 60169-15, EN 122110, MIL-STD-348A, Fig. 310
Electrical data Elektrische Daten	
Impedance Wellenwiderstand	50 Ω
Frequency range Frequenzbereich	DC to 18 GHz
Return loss (cable connector straight) Rückflussdämpfung (Kabelsteckverbinder gerade)	≥ 30 dB (typ.)
Insertion loss Dämpfung	≤ 0.04 x √f (GHz) dB
Insulation resistance Isolationswiderstand	≥ 5 GΩ
Center contact resistance Übergangswiderstand Innenleiter	≤ 3 mΩ
Outer contact resistance Übergangswiderstand Außenleiter	≤ 2 mΩ
Test voltage Prüfspannung	1000 V rms
Working voltage Betriebsspannung	480 V rms
Power handling Leistungsbelastbarkeit	200 W @ 2 GHz
RF leakage - Interface Schirmdämpfung	≥ 100 dB @ DC to 1 GHz
Mechanical data Mechanische Daten	
Mating cycles Steckzyklen	CuBe or equivalent / stainless steel: ≥ 500 CuZn: ≥ 100
Coupling nut retention Überwurfmutter Haltekraft	CuBe or equivalent / stainless steel: ≥ 270 N CuZn: ≥ 180 N
Center contact captivation Innenleiter Haltekraft	CuBe or equivalent / stainless steel: axial: ≥ 27 N, radial: ≥ 3 Ncm CuZn: axial: ≥ 20 N, radial: ≥ 1 Ncm
Coupling test torque Prüfdrehmoment	CuBe or equivalent / stainless steel: ≤ 1.7 Nm CuZn: ≤ 0.6 Nm
Coupling torque recommended Drehmoment empfohlen	CuBe or equivalent / stainless steel: 0.8 Nm to 1.1 Nm CuZn: 0.5 Nm
Environmental data Umweltdaten	
Temperature range Temperaturbereich	-65 °C to +165 °C
Thermal shock Temperaturzyklen	MIL-STD-202, Method 107, Condition B
Corrosion resistance Korrosionsbeständigkeit	MIL-STD-202, Method 101, Condition B
Moisture resistance Feuchtigkeitsbeständigkeit	MIL-STD-202, Method 106
Vibration Vibration	MIL-STD-202, Method 204, Condition D
Shock Schock	MIL-STD-202, Method 213, Condition I
Max. soldering temperature (PCB connectors) Max. Löttemperatur (Leiterplattensteckverbinder)	IEC 61760-1, +260 °C for 10 sec.
Materials Materialien	
Spring loaded contact parts Federnde Kontaktteile	CuBe, Au plating
Center contact Innenleiter	CuZn, Au plating
Outer contact Außenleiter	CuBe or equivalent, Au / white bronze plating Stainless steel, passivated / Au plating CuZn, Au / white bronze plating
Body Gehäuse	CuBe or equivalent, Au / white bronze plating Stainless steel, passivated / Au plating CuZn, Au / white bronze plating
Coupling nut Überwurfmutter	CuBe or equivalent, Au / white bronze plating Stainless steel, passivated / Au plating CuZn, Au / white bronze plating
Crimping ferrule Crimphülse	Cu, Au / white bronze plating
Dielectric Dielektrikum	PTFE
Gasket Dichtung	Silicon / Rubber

Rosenberger connectors generally fulfill the indicated technical data. Individual values of connectors may deviate depending upon application, design, type of cable, assembly method and workmanship. Data sheets for particular products can be downloaded on our website or can be provided on request from your Rosenberger sales partner.

Rosenberger-Steckverbinder erfüllen grundsätzlich die hier angegebenen technischen Daten. Je nach Anwendung, Bauart, Kabeltyp, Montageart und -ausführung können einzelne Werte der Steckverbinder hiervon abweichen. Datenblätter zu einzelnen Produkten können Sie von unserer Website herunterladen oder auf Anfrage von Ihrem Rosenberger-Ansprechpartner erhalten.

Cable Connectors Semi-Rigid Cables



Straight Plug, solder without pin, without dielectric

Semi-Rigid Cables

Rosenberger No.	Order No.	Sales Unit	Packaging	Remarks	Cable Group	
32 S 121-272 S	107723	100	standard	Outer Contact: CuBe or equivalent, Au plating Coupling Nut: stainless steel, passivated	72	

Straight Plug, solder soldered center contact

Semi-Rigid Cables

Rosenberger No.	Order No.	Sales Unit	Packaging	Remarks	Cable Group	
32 S 101-270 L5	101755	25	standard	CuBe or equivalent, Au plating	70	
32 S 102-271 L5	180587	100	standard	CuBe or equivalent, Au plating MIL-PRF-39012/79-4005	71	
32 S 102-272 L5	180309	100	standard	CuBe or equivalent, Au plating MIL-PRF-39012/79-4006	72	
32 S 122-271 S5	180644	100	standard	Outer Contact: CuBe or equivalent, Au plating Coupling Nut: stainless steel, passivated MIL-PRF-39012/79-3005	71	
32 S 122-272 S5	180810	100	standard	Outer Contact: CuBe or equivalent, Au plating Coupling Nut: stainless steel, passivated MIL-PRF-39012/79-3006	72	

Right Angle Plug, solder

Semi-Rigid Cables

Rosenberger No.	Order No.	Sales Unit	Packaging	Remarks	Cable Group	
32 S 206-271 L5	180059	100	standard	CuBe or equivalent, Au plating	71	
32 S 206-272 L5	181242	100	standard	CuBe or equivalent, Au plating	72	

Straight Jack, solder

Semi-Rigid Cables

Rosenberger No.	Order No.	Sales Unit	Packaging	Remarks	Cable Group	
32 K 101-271 L5	180113	25	standard	CuBe or equivalent, Au plating MIL-PRF-39012/81-4005	71	
32 K 101-272 L5	180118	25	standard	CuBe or equivalent, Au plating MIL-PRF-39012/81-4006	72	

Panel Jack, solder, 4-hole flange

Semi-Rigid Cables

Rosenberger No.	Order No.	Sales Unit	Packaging	Remarks	Cable Group	
32 K 401-271 L5	180466	50	blister	CuBe or equivalent, Au plating 4-hole flange 12.7 mm 4 x Ø 2.6 mm MIL-PRF-39012/82-4005	71	
32 K 401-272 L5	106458	25	standard	CuBe or equivalent, Au plating 4-hole flange 12.7 mm 4 x Ø 2.6 mm MIL-PRF-39012/82-4006	72	

Panel Jack, solder, hexagonal flange



Semi-Rigid Cables

Rosenberger No.	Order No.	Sales Unit	Packaging	Remarks	Cable Group	
32 K 601-271 L5	186139	50	standard	CuBe or equivalent, Au plating hexagonal flange rear mount MIL-PRF-39012/83-4005	71	
	144810	100	standard		71	
32 K 601-272 L5	180816	25	standard	CuBe or equivalent, Au plating hexagonal flange rear mount MIL-PRF-39012/83-4006	72	

Cable Connectors - Flexible Cables



Straight Plug, solder-crimp

Flexible Cables

Rosenberger No.	Order No.	Sales Unit	Packaging	Remarks	Cable Group	
32 S 107-302 L5	104941	100	standard	CuBe or equivalent, Au plating	02	
32 S 107-303 L5	183429	100	standard	CuBe or equivalent, Au plating	03	
32 S 107-306 L5	105601	100	standard	CuBe or equivalent, Au plating	06	
32 S 107-307 L5	107400	100	standard	CuBe or equivalent, Au plating	07, 08	
32 S 107-302 N5	272663	100	standard	CuBe or equivalent, White bronze plating	02	
32 S 107-303 N5	272668	100	standard	CuBe or equivalent, White bronze plating	03	
32 S 107-307 N5	272669	100	standard	CuBe or equivalent, White bronze plating	07	



Right Angle Plug, solder-crimp

Flexible Cables

Rosenberger No.	Order No.	Sales Unit	Packaging	Remarks	Cable Group	
32 S 207-302 L5	180969	100	standard	CuBe or equivalent, Au plating	02	
32 S 207-303 L5	108424	100	standard	CuBe or equivalent, Au plating	03	
32 S 207-306 L5	100422	100	standard	CuBe or equivalent, Au plating	06	
32 S 207-307 L5	100866	100	standard	CuBe or equivalent, Au plating	07, 08	
32 S 207-303 N5	272672	100	standard	CuBe or equivalent, White bronze plating	03	
32 S 207-306 N5	273730	100	standard	CuBe or equivalent, White bronze plating	06	
32 S 207-307 N5	272675	100	standard	CuBe or equivalent, White bronze plating	07	

Straight Jack, solder-crimp

Flexible Cables

Rosenberger No.	Order No.	Sales Unit	Packaging	Remarks	Cable Group	
32 K 107-302 L5	105180	25	standard	CuBe or equivalent, Au plating	02	
32 K 107-303 L5	103075	25	standard	CuBe or equivalent, Au plating	03	
32 K 107-306 L5	103935	25	standard	CuBe or equivalent, Au plating	06	
32 K 107-307 L5	105796	25	standard	CuBe or equivalent, Au plating	07, 08	



Panel Jack, solder-crimp, 4-hole flange

Flexible Cables

Rosenberger No.	Order No.	Sales Unit	Packaging	Remarks	Cable Group	
32 K 407-302 L5	108093	25	standard	CuBe or equivalent, Au plating 4-hole flange 12.7 mm 4 x Ø 2.6 mm	02	
32 K 407-303 L5	107890	25	standard	CuBe or equivalent, Au plating 4-hole flange 12.7 mm 4 x Ø 2.6 mm	03	

Panel Jack, solder-crimp, hexagonal flange

Flexible Cables

Rosenberger No.	Order No.	Sales Unit	Packaging	Remarks	Cable Group	
32 K 607-302 L5	104992	50	standard	CuBe or equivalent, Au plating hexagonal flange rear mount	02	
32 K 607-303 L5	105326	25	standard	CuBe or equivalent, Au plating hexagonal flange rear mount	03	
32 K 607-303 N5	272677	25	standard	CuBe or equivalent, White bronze plating hexagonal flange rear mount	03	

Panel Connectors - Solder End

Panel Jack, 4-hole flange

Solder End

Rosenberger No.	Order No.	Sales Unit	Packaging	Remarks	
32 K 421-200 E3	105829	25	blister	stainless steel, Au plating 4-hole flange 12.7 mm 4 x Ø 2.6 mm MIL-PRF-39012/60-3001	

Right Angle Panel Jack, 4-hole flange

Solder End

Rosenberger No.	Order No.	Sales Unit	Packaging	Remarks	
32 K 241-200 L5	143090	100	blister	CuZn, Au plating 4-hole flange 12.7 mm 4 x Ø 2.6 mm	

Panel Jack, 2-hole flange

Solder End

Rosenberger No.	Order No.	Sales Unit	Packaging	Remarks	
32 K 701-200 E3	101418	50	blister	stainless steel, Au plating 2-hole flange 16 mm 2 x Ø 2.6 mm MIL-PRF-39012/60-4002	

Panel Jack, hexagonal flange

Solder End

Rosenberger No.	Order No.	Sales Unit	Packaging	Remarks	
32 K 603-200 L5	101268	50	standard	CuBe or equivalent, Au plating hexagonal flange rear mount	

Panel Connectors - Coaxial End

Panel Plug Straight Terminal
4-hole flange

Coaxial End

Rosenberger No.	Order No.	Sales Unit	Packaging	Remarks	
32 S 422-500 S5	104346	25	standard	stainless steel, passivated 4-hole flange 12.7 mm 4 x Ø 2,6 mm length 30.6 mm	

Panel Jack, solder mount

Coaxial End

Rosenberger No.	Order No.	Sales Unit	Packaging	Remarks	
32 K 103-5H0 L5	108390	5	blister	CuBe or equivalent, Au plating sealed with a glass feedthru matched to 50 Ω Leakage rate < 10 ⁻⁶ mbar x l / sec. Pressure max. 2 N/mm ² hermetic sealed	

Panel Jack Straight Terminal

Coaxial End

Rosenberger No.	Order No.	Sales Unit	Packaging	Remarks	
32 K 141-500 L5	102188	100	standard	CuZn, Au plating	

Panel Jack Straight Terminal
hexagonal flange

Coaxial End

Rosenberger No.	Order No.	Sales Unit	Packaging	Remarks	
32 K 644-500 L5	106215	50	blister	CuZn, Au plating	

Panel Jack Straight Terminal 4-hole flange

Coaxial End

Rosenberger No.	Order No.	Sales Unit	Packaging	Remarks	
32 K 441-500 L5	180487	50	blister	CuZn, Au plating 4-hole flange 12.7 mm 4 x Ø 2.6 mm length 14.6 mm	
32 K 486-500 L5	107946	50	blister	CuZn, Au plating 4-hole flange 12.7 mm 4 x Ø 2.6 mm length 17 mm	
32 K 44N-500 L5	205084	50	blister	CuZn, Au plating 4-hole flange 12.7 mm 4 x Ø 2.6 mm length 20.5 mm	
32 K 482-500 N5	102800	25	blister	CuZn, white bronze plating 4-hole flange 12.7 mm 4 x Ø 2.6 mm length 21.5 mm	
32 K 449-500 L5	166468	50	blister	CuZn, Au plating 4-hole flange 12.7 mm 4 x Ø 2.6 mm length 27.4 mm	
32 K 402-500 E3	107207	50	blister	stainless steel, Au plating 4-hole flange 12.7 mm 4 x Ø 2.6 mm length 27.4 mm captivated center contact	
32 K 422-500 S5	186127	50	blister	stainless steel, passivated 4-hole flange 12.7 mm 4 x Ø 2.6 mm length 27.4 mm captivated center contact	

Panel Jack Straight Terminal 2-hole flange



Coaxial End

Rosenberger No.	Order No.	Sales Unit	Packaging	Remarks	
32 K 722-500 E3	106766	25	standard	stainless steel, Au plating 2-hole flange 16 mm 2 x Ø 2.6 mm length 27.4 mm captivated center contact	

Panel Connectors - Stripline according MIL M83517

Panel Jack, 4-hole flange

Stripline

Rosenberger No.	Order No.	Sales Unit	Packaging	Remarks	
32 K 421-600 S5	102255	25	blister	stainless steel, passivated 4-hole flange 12.7 mm 4 x Ø 2.6 mm length 12 mm	
32 K 441-600 L5	100392	25	blister	CuZn, Au plating 4-hole flange 12.7 mm 4 x Ø 2.6 mm length 12 mm	
32 K 424-600 S5	104815	25	blister	stainless steel, passivated 4-hole flange 12.7 mm 4 x Ø 2.6 mm length 13.7 mm	

Panel Jack, 2-hole flange

Stripline

Rosenberger No.	Order No.	Sales Unit	Packaging	Remarks	
32 K 724-600 S5	102406	25	blister	stainless steel, passivated 2-hole flange 12.7 mm 2 x Ø 2.6 mm length 13.7 mm	

Panel Jack, 4-hole flange

Microstrip

Rosenberger No.	Order No.	Sales Unit	Packaging	Remarks	
32 K 421-700 S5	106562	25	blister	stainless steel, passivated 4-hole flange 12.7 mm 4 x Ø 2.6 mm length 10.8 mm	

PCB Connectors - SMD

Straight Jack, PCB

SMD

Rosenberger No.	Order No.	Sales Unit	Packaging	Remarks	
32 K 10A-40M L5	142174	100	blister	CuZn, Au plating	



Right Angle Jack, PCB

SMD

Rosenberger No.	Order No.	Sales Unit	Packaging	Remarks	
32 K 242-40M L5	157634	500	tape & reel	CuZn, Au plating	
	103746	100	blister		

Right Angle Panel Jack, PCB, edge mount

SMD

Rosenberger No.	Order No.	Sales Unit	Packaging	Remarks	
32 K 243-40M L5	168322	50	blister	CuZn, Au plating for panel thickness 0 mm to 2.5 mm	
32 K 145-400 L5	180380	100	blister	CuZn, Au plating for panel thickness 1.8 mm	

PCB Connectors - Solder Pin

Straight Jack, PCB**Solder Pin**

Rosenberger No.	Order No.	Sales Unit	Packaging	Remarks	
32 K 101-400 L5	180119	100	blister	CuBe or equivalent, Au plating	

Right Angle Jack, PCB**Solder Pin**

Rosenberger No.	Order No.	Sales Unit	Packaging	Remarks	
32 K 201-400 L5	180273	100	blister	CuBe or equivalent, Au plating without stand-off	

Right Angle Panel Jack, PCB**Solder Pin**

Rosenberger No.	Order No.	Sales Unit	Packaging	Remarks	
32 K 246-400 L5	180442	100	blister	CuZn, Au plating	

Adaptors

Adaptors SMA - SMA

Rosenberger No.	Order No.	Sales Unit	Packaging	Remarks	
32 S 103-S00 L5	101017	1	standard	SMA male - male Outer contact: stainless steel, Au plating Coupling Nut: CuBe or equivalent, Au plating	
32 S 105-K00 L5	180625	1	standard	SMA male - female CuBe or equivalent, Au plating	
32 K 101-K00 L5	183610	1	standard	SMA female - female CuBe or equivalent, Au plating	
32 K 101-KH0 L5	180124	1	standard	SMA female - female CuBe or equivalent, Au plating round flange panel thickness max. 4.8 mm hermetic sealed	
32 K 601-K00 L5	275305	1	standard	SMA female - female CuBe or equivalent, Au plating hexagonal flange panel thickness max. 6.4 mm	
32 S 221-K00 L5	108701	1	standard	SMA male - female right angle CuBe or equivalent, Au plating	
32 S 301-K00 L5	101491	1	standard	SMA female - male - female T-adaptor CuBe or equivalent, Au plating This adaptor is a non-matched 3 dB divider for LF applications	
32 K 301-K00 L5	180464	1	standard	SMA female - female - female T-adaptor CuBe or equivalent, Au plating This adaptor is a non-matched 3 dB divider for LF applications	





Adaptors SMA - P-SMP

Rosenberger No.	Order No.	Sales Unit	Packaging	Remarks	
119 S 132-S00 S5	197285	1	standard	P-SMP male - SMA male	
119 S 132-K00 S5	210521	1	standard	P-SMP male - SMA female	
119 K 132-S00 L5	197683	1	standard	P-SMP female - SMA male	
119 K 132-K00 L5	210505	1	standard	P-SMP female - SMA female	
119 K 732-K0B S5	226655	1	standard	P-SMP female - SMA female 2-hole flange floating test adaptor	

Adaptors SMA - QMA

Rosenberger No.	Order No.	Sales Unit	Packaging	Remarks	
28 S 132-S00 N5	157980	1	standard	QMA male - SMA male	
28 S 132-K00 N5	154721	1	standard	QMA male - SMA female	
28 K 132-S00 N5	147025	1	standard	QMA female - SMA male	
28 K 132-K00 N5	156117	1	standard	QMA female - SMA female	

Adaptors SMA - BNC 50 Ω

Rosenberger No.	Order No.	Sales Unit	Packaging	Remarks	
32 S 151-S00 L5	103531	1	standard	SMA male - BNC male	
32 S 151-K00 L5	106545	1	standard	SMA male - BNC female	
32 K 151-S00 L5	103503	1	standard	SMA female - BNC male	
32 K 151-K00 L5	102638	1	standard	SMA female - BNC female	



Adaptors SMA - TNC 50 Ω

Rosenberger No.	Order No.	Sales Unit	Packaging	Remarks	
32 S 156-S00 L5	104498	1	standard	SMA male - TNC male	
32 S 156-K00 L5	107063	1	standard	SMA male - TNC female	
56 S 132-K00 L5	192179	1	standard	TNC male - SMA female	
56 K 132-K00 L5	108760	1	standard	TNC female - SMA female	

Adaptors SMA - N 50 Ω

Rosenberger No.	Order No.	Sales Unit	Packaging	Remarks	
32 S 153-S00 L5	102934	1	standard	SMA male - N male	
32 S 153-K00 L5	101424	1	standard	SMA male - N female	
53 S 132-K00 L5	189568	1	standard	N male - SMA female	
53 K 132-K00 L5	108780	1	standard	N female - SMA female	
32 S 453-K00 L5	107096	1	standard	SMA male - N female 4-hole flange	
32 K 453-K00 L5	100755	1	standard	SMA female - N female 4-hole flange	

Adaptors SMA - SMA Reverse

Rosenberger No.	Order No.	Sales Unit	Packaging	Remarks	
32R S 132-K00 L5	159287	1	standard	SMA Reverse male - SMA Standard female	
32R K 132-S00 L5	180528	1	standard	SMA Reverse female - SMA Standard male	

Adaptors SMA - 1.0-2.3 DIN 41626

Rosenberger No.	Order No.	Sales Unit	Packaging	Remarks	
32 K 145-S00 L5	103442	1	standard	SMA female - 1.0-2.3 DIN 41626 male	



Adaptors SMA - MCX

Rosenberger No.	Order No.	Sales Unit	Packaging	Remarks	
29 S 132-K01 N5	151696	1	standard	MCX male - SMA female hexagonal flange	

Adaptors SMA - SMB

Rosenberger No.	Order No.	Sales Unit	Packaging	Remarks	
59 S 132-K00 L5	182491	1	standard	SMB male - SMA female	
59 K 132-K00 L5	182487	1	standard	SMB female - SMA female	
59 K 132-S00 L5	104605	1	standard	SMB female - SMA male	
59 S 132-S00 L5	108160	1	standard	SMB male - SMA male	



Adaptors SMA - SMC

Rosenberger No.	Order No.	Sales Unit	Packaging	Remarks	
39 S 132-S00 L5	101139	1	standard	SMC male - SMA male	
39 S 132-K00 L5	104040	1	standard	SMC male - SMA female	
39 K 132-K00 L5	180220	1	standard	SMC female - SMA female	



Adaptors SMA - SMP

Rosenberger No.	Order No.	Sales Unit	Packaging	Remarks	Return Loss	
19 S 132-S00 S3	100585	1	standard	SMP male - SMA male		
19 K 132-S00 D3	150878	1	standard	SMP female - SMA male		
19 S 132-K00 S3	101244	1	standard	SMP male - SMA female		
19 K 132-K00 D3	105168	1	standard	SMP female - SMA female		
17 K 732-K0A S5	243229	1	standard	Longwipe-SMP female - SMA female 2-hole flange floating test adaptor	≥ 23 dB @ DC to 3 GHz ≥ 20 dB @ 3 GHz to 6 GHz	

Adaptors SMA - 7-16

Rosenberger No.	Order No.	Sales Unit	Packaging	Remarks	
32 K 160-S00 N5	157551	1	standard	SMA female - 7-16 male	
32 S 160-S00 N5	160222	1	standard	SMA male - 7-16 male	

Adaptors SMA - 4.3-10

Rosenberger No.	Order No.	Sales Unit	Packaging	Remarks	
32 K 164-S00 N1	259821	1	standard	SMA female - 4.3-10 male screw type	
32 S 164-K00 N1	259820	1	standard	SMA male - 4.3-10 female	

Adaptors SMA - FMC

Rosenberger No.	Order No.	Sales Unit	Packaging	Remarks	
16 S 132-K00 L5	163582	5	standard	FMC male - SMA female	



Adaptors SMA - RPC-N 50 Ω

Rosenberger No.	Order No.	Sales Unit	Packaging	Remarks	Return Loss	
05 S 132-S00 S3	103663	1	standard	RPC-N 50 Ω male - SMA male	≥ 23 dB @ DC to 18 GHz	
05 S 132-K00 S3	107667	1	standard	RPC-N 50 Ω male - SMA female	≥ 23 dB @ DC to 18 GHz	
05 K 132-S00 S3	106954	1	standard	RPC-N 50 Ω female - SMA male	≥ 23 dB @ DC to 18 GHz	
05 K 132-K00 S3	101188	1	standard	RPC-N 50 Ω female - SMA female	≥ 23 dB @ DC to 18 GHz	
05 S 432-S00 S3	106111	1	standard	RPC-N 50 Ω male - SMA male 4-hole flange 25.4 mm	≥ 23 dB @ DC to 18 GHz	
05 S 432-K00 S3	104647	1	standard	RPC-N 50 Ω male - SMA female 4-hole flange 25.4 mm	≥ 23 dB @ DC to 18 GHz	
05 K 432-S00 S3	101117	1	standard	RPC-N 50 Ω female - SMA male 4-hole flange 25.4 mm	≥ 23 dB @ DC to 18 GHz	
05 K 432-K00 S3	105197	1	standard	RPC-N 50 Ω female - SMA female 4-hole flange 25.4 mm	≥ 23 dB @ DC to 18 GHz	



Adaptors SMA - RPC-TNC

Rosenberger No.	Order No.	Sales Unit	Packaging	Remarks	Return Loss	
06 S 132-S00 S3	104496	1	standard	RPC-TNC male - SMA male	≥ 19 dB @ DC to 18 GHz	
06 S 132-K00 S3	105636	1	standard	RPC-TNC male - SMA female	≥ 19 dB @ DC to 18 GHz	
06 K 132-S00 S3	103106	1	standard	RPC-TNC female - SMA male	≥ 19 dB @ DC to 18 GHz	
06 K 132-K00 S3	107148	1	standard	RPC-TNC female - SMA female	≥ 19 dB @ DC to 18 GHz	

Adaptors SMA - RPC-7

Rosenberger No.	Order No.	Sales Unit	Packaging	Remarks	Return Loss	
07 P 132-S00 S3	103063	1	standard	RPC-7 - SMA male	≥ 23 dB @ DC to 18 GHz	
07 P 132-K00 S3	148627	1	standard	RPC-7 - SMA female	≥ 23 dB @ DC to 18 GHz	

Adaptors SMA - Micro-RF

Rosenberger No.	Order No.	Sales Unit	Packaging	Remarks	
15 S 132-K04 L5	155284	1	standard	Micro-RF male - SMA female for 15 K 101-40M E4 slide-on Mating cycles $\geq 200,000$	
15 S 132-K02 L5	161744	1	standard	Micro-RF male - SMA female for 15 K 101-40M E4 snap-on Mating cycles $\geq 10,000$	
15 S 132-K05 L5	155288	1	standard	Micro-RF male - SMA female for 15 K 101-40M E4 snap-on Mating cycles $\geq 10,000$	

Terminations

Termination Pug

Rosenberger No.	Order No.	Sales Unit	Packaging	Remarks	Return Loss
32 S 15R-0.5 E3	102158	10	blister	0.5 Watt Frequency: DC to 12.4 GHz	≥ 32.2 dB @ DC to 2 GHz ≥ 26.4 dB @ 2 GHz to 8 GHz ≥ 21.2 dB @ 8 GHz to 12.4 GHz
32 S 17R-0.5 E3	143523	10	blister	0.5 Watt Frequency: DC to 18 GHz	≥ 32.2 dB @ DC to 2 GHz ≥ 26.4 dB @ 2 GHz to 8 GHz ≥ 21.2 dB @ 8 GHz to 12.4 GHz ≥ 20.8 dB @ 12.4 GHz to 18 GHz
32 S 15R-1.0 E3	104116	10	blister	1 Watt Frequency: DC to 18 GHz	≥ 28.3 dB @ DC to 4 GHz ≥ 26.4 dB @ 4 GHz to 6 GHz ≥ 24.3 dB @ 6 GHz to 10 GHz ≥ 23.1 dB @ 10 GHz to 12.4 GHz ≥ 22.1 dB @ 12.4 GHz to 14 GHz ≥ 19.1 dB @ 14 GHz to 18 GHz



Termination Jack

Rosenberger No.	Order No.	Sales Unit	Packaging	Remarks	Return Loss
32 K 15R-001 E3	100375	10	blister	1 Watt Frequency: DC to 12.4 GHz	≥ 32.2 dB @ DC to 2 GHz ≥ 26.4 dB @ 2 GHz to 8 GHz ≥ 21.2 dB @ 8 GHz to 12.4 GHz
32 K 17R-001 E3	137568	10	standard	1 Watt Frequency: DC to 18 GHz	≥ 32.2 dB @ DC to 2 GHz ≥ 26.4 dB @ 2 GHz to 8 GHz ≥ 21.2 dB @ 8 GHz to 12.4 GHz ≥ 20.8 dB @ 12.4 GHz to 18 GHz





Accessories

Protection Cap with chain

Rosenberger No.	Order No.	Sales Unit	Packaging	Remarks	
32 Z 112-000 F	102320	1	standard	male with chain	

Short

Rosenberger No.	Order No.	Sales Unit	Packaging	Remarks	
32 Z 111-000 L5	104865	1	standard	male	
32 Z 114-000 L5	100327	1	standard	female	

Special Tools

Torque Wrench

Rosenberger No.	Order No.	Sales Unit	Packaging	Remarks	
32 W 100-016	103855	1	standard	SMA torque 0.9 Nm flat 8 mm	

Assembly Tool Kit SMA

for Semi Rigid Cables

Rosenberger No.	Order No.	Sales Unit	Packaging	Remarks	
32 W 100-000	102773	1	box	complete tool set in plastic box	

**Contents of the Assembly Tool Kit
for Semi Rigid Cables (32 W 100-000)**

Rosenberger No.	Order No.	Sales Unit	Packaging	Remarks
32 W 100-001	102044	1	standard	Soldering Fixture Lötvorrichtung
32 W 100-002	104396	1	standard	Insert for RG 405 Backen für RG 405
32 W 100-003	105898	1	standard	Insert for RG 405 Backen für RG 405
32 W 100-004	102850	1	standard	Jack Locator Fixierschraube für Kuppler
32 W 100-005	104607	1	standard	Plug Locator Fixierschraube für Stecker
32 W 100-006	102502	1	standard	Soldering Gauge 0.25 mm Distanzlehre 0.25 mm
32 W 100-007	100680	1	standard	Soldering Gauge 0.4 mm Distanzlehre 0.4 mm
32 W 100-008	106817	1	standard	Contact Support (for Plug and Jack) Kontakthalter (für Stecker und Kuppler)
32 W 100-009	103318	1	standard	Dielectric Insertion Tool for Plug Isolierteil-Einpresswerkzeug für Stecker
32 W 100-010	107090	1	standard	Dielectric Insertion Tool for Jack Isolierteil-Einpresswerkzeug für Kuppler
32 W 100-011	108733	1	standard	Assembly Jig (Center Contact + Insulator) Montagelehre (Innenleiter + Isolierteil)
32 W 100-012	100798	1	standard	Assembly Jig (Outer Contact + Coupling Nut) Montagelehre (Außenleiter + Überwurfmutter)
32 W 100-013	102523	1	standard	Assembly Jig (Center Contact + Insulator) Montagelehre (Innenleiter + Isolierteil)
32 W 100-014	104294	1	standard	Cutting Tool Planschneidewerkzeug
32 W 100-015	108584	1	standard	Sharpening Tool Anspitzwerkzeug
32 W 100-016	103855	1	standard	Torque Wrench (0.9 Nm) Drehmomentschlüssel (0.9 Nm)
32 W 100-017	103665	1	standard	Insulator Insertion Tool Andrückwerkzeug für Isolierteil
32 W 100-018	103451	1	standard	Insulator Press-in Tool Einpresswerkzeug für Isolierteil
32 W 100-022/01	119710	1	standard	Conical Sleeve Kegelhülse
32 W 100-022/02	112888	1	standard	Arrester Gegenhalter
32 W 100-022/03	109562	1	standard	Fixing Tool I Stössel I
32 W 100-022/04	121928	1	standard	Fixing Tool II Stössel II

QMA



Characteristics and dimensions of QMA connectors are based on the SMA connector interface. QMA connectors are designed for applications up to 18 GHz, the quick-lock coupling mechanism enables fast, easy and reliable connections in the tightest spaces, primarily in mobile base stations. Assembly tools are not necessary.

Rosenberger provides the following QMA connector versions:

QLF® quick-lock coupling mechanism and plastic quick-lock coupling mechanism in 4 different coloured codings

QMA-Steckverbinder bauen in Eigenschaften und Abmessungen auf der Serie SMA auf und sind für Anwendungen bis 18 GHz konzipiert. Der Quick-Lock-Einrastmechanismus ermöglicht schnelle, zuverlässige und einfache Steckverbindungen auf engstem Raum, z. B. in Mobilfunk-Basistationen, Werkzeuge sind nicht erforderlich.

Rosenberger bietet QMA-Steckverbinder in folgenden Ausführungen an:

QLF® Quick-Lock-Einrastmechanismus und Kunststoff-Quick-Lock-Einrastmechanismus in vier verschiedenen Farbkodierungen

QMA

QMA



Interface Dimensions QMA

Code 28

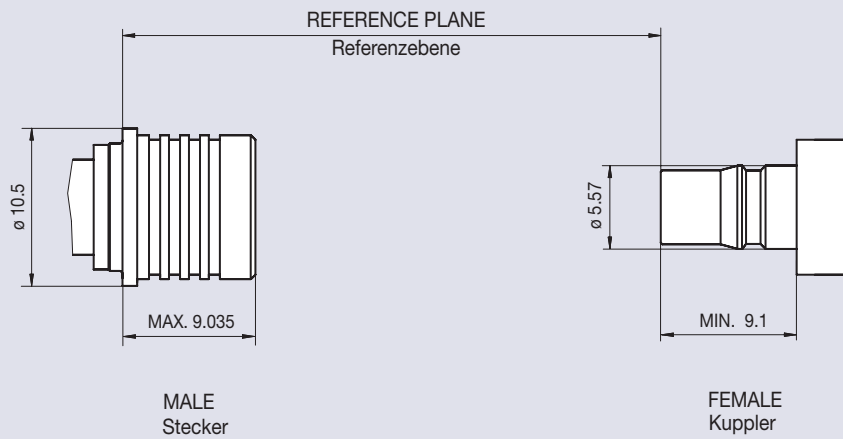

Rosenberger is authorized to act as QLF[®] manufacturer. Rosenberger QMA connectors fulfill the QLF[®] standard (Quick Lock Formula, a registered trademark). QLF[®] guarantees full intermateability between connectors produced by licensing agreement parties. Rosenberger as licensee is free to market QMA connectors as QLF[®] products. For further information, please see: www.qf.info

Rosenberger ist autorisierter QLF[®]-Hersteller. Rosenberger QMA-Steckverbinder entsprechen dem QLF[®]-Standard, der als Warenzeichen eingetragen ist. QLF[®] (Quick Lock Formula) stellt die Steckbarkeit von Produkten der Lizenzparteien sicher. Rosenberger ist als Lizenznehmer berechtigt, QMA-Steckverbinder als QLF[®]-Produkte zu vermarkten. Weitere Informationen unter: www.qf.info



Features

- ▶ Interface according to QLF (Quick Lock Formula)
- ▶ Frequency range DC to 18 GHz
- ▶ Return loss (cable connector straight) ≥ 25 dB @ 3 GHz to 6 GHz
- ▶ Minimum pitch: 12.4 mm
- ▶ Flexibility: 360° turnable
- ▶ Impedance 50 Ω
- ▶ Quick-lock coupling

Product Range

- ▶ Cable connectors
- ▶ Panel connectors
- ▶ PCB connectors
- ▶ Adaptors
- ▶ Terminations

Technical Data QMA

Code 28

Applicable standards Anwendbare Normen	
Interface according to Interface gemäß	QLF® (Quick Lock Formula) Rosenberger is an authorized QLF® manufacturer
Electrical data Elektrische Daten	
Impedance Wellenwiderstand	50 Ω
Frequency range Frequenzbereich	DC to 18 GHz
Return loss (cable connector straight) Rückflusdämpfung (Kabelsteckverbinder gerade)	≥ 32 dB @ DC to 3 GHz ≥ 25 dB @ 3 GHz to 6 GHz
Insertion loss Dämpfung	≤ 0.05 x √f (GHz) dB
Insulation resistance Isolationswiderstand	≥ 5 GΩ
Center contact resistance Übergangswiderstand Innenleiter	≤ 3 mΩ
Outer contact resistance Übergangswiderstand Außenleiter	≤ 2.5 mΩ
Test voltage Prüfspannung	1000 V rms
Working voltage Betriebsspannung	480 V rms
Power handling Leistungsbelastbarkeit	70 W @ 2.2 GHz (recommended)
RF leakage - Interface Schirmdämpfung	≥ 95 dB @ DC to 2 GHz ≥ 80 dB @ 2 GHz to 4 GHz ≥ 70 dB @ 4 GHz to 6 GHz
Intermodulation 3rd order Intermodulation 3. Ordnung	≤ -120 dBc (2 x 43 dBm)
Mechanical data Mechanische Daten	
Mating cycles Steckzyklen	≥ 100
Interface retention force Interface Haltekraft	≥ 60 N
Engagement force Steckkraft	≤ 25 N
Disengagement force Ziehkraft	≤ 20 N
Pitch Packungsdichte	≥ 12.4 mm
Environmental data Umweltdaten	
Temperature range Temperaturbereich	-40 °C to +85 °C
Thermal shock Temperaturzyklen	IEC 61169-1, Sub-clause 9.4.4 (-40 °C / +85 °C)
Damp heat Feuchte Wärme	IEC 60169-1, Sub-clause 16.3 (96 hrs; steady state)
Corrosion resistance Korrosionsbeständigkeit	IEC 60169-1, Sub-clause 16.7 (48 hrs)
Vibration Vibration	IEC 60068-2-64 random
Max. soldering temperature (PCB connectors) Max. Löttemperatur (Leiterplattensteckverbinder)	IEC 61760-1, +260 °C for 10 sec.
Materials Materialien	
Spring loaded contact parts Federnde Kontaktteile	CuBe / CuSn, Au plating
Center contact Innenleiter	CuZn, Au plating
Outer contact Außenleiter	CuZn, Au / white bronze plating
Body Gehäuse	CuZn, Au / white bronze plating
Locking sleeve Verriegelungshülse	QLF®: CuZn, white bronze plating Plastic: POM (black, blue, green, red)
Crimping ferrule Crimphülse	Cu, Au / white bronze plating
Dielectric Dielektrikum	PTFE
Gasket Dichtung	Silicon

Rosenberger connectors generally fulfill the indicated technical data. Individual values of connectors may deviate depending upon application, design, type of cable, assembly method and workmanship. Data sheets for particular products can be downloaded on our website or can be provided on request from your Rosenberger sales partner.

Rosenberger-Steckverbinder erfüllen grundsätzlich die hier angegebenen technischen Daten. Je nach Anwendung, Bauart, Kabeltyp, Montageart und -ausführung können einzelne Werte der Steckverbinder hiervon abweichen. Datenblätter zu einzelnen Produkten können Sie von unserer Website herunterladen oder auf Anfrage von Ihrem Rosenberger-Ansprechpartner erhalten.

Cable Connectors Semi-Rigid Cables

**Straight Plug, solder
without pin, without dielectric**

Semi-Rigid Cables

Rosenberger No.	Order No.	Sales Unit	Packaging	Remarks	Cable Group	
28 S 101-272 N	218302	25	standard	QLF®	72	



Straight Plug, plug-in/solder

Semi-Rigid Cables

Rosenberger No.	Order No.	Sales Unit	Packaging	Remarks	Cable Group	
28 S 107-271 N5	149573	25	standard	QLF®	71	
28 S 107-272 N5	148860	50	standard	QLF®	72	

Right Angle Plug, solder

Semi-Rigid Cables

Rosenberger No.	Order No.	Sales Unit	Packaging	Remarks	Cable Group	
28 S 206-271 N5	151556	100	standard	QLF®	71	
28 S 208-272 N5	199214	100	standard	QLF®	72	

Panel Jack, plug-in/solder, hexagonal flange



Semi-Rigid Cables

Rosenberger No.	Order No.	Sales Unit	Packaging	Remarks	Cable Group	
28 K 607-271 L5	159305	25	standard	QLF®	71	
28 K 607-272 L5	148861	50	standard	QLF®	72	

Cable Connectors - Flexible Cables

Straight Plug, full crimp

Flexible Cables

Rosenberger No.	Order No.	Sales Unit	Packaging	Remarks	Cable Group	
28 S 107-102 N5	156467	50	standard	QLF®	02	
28 S 161-102 N5	263993	50	standard	IP 68 (mated pair)	02	
28 S 107-103 N5	149572	50	standard	QLF®	03	
28 S 147-103 N5-bl	153641	25	standard	blue POM sleeve	03	
28 S 147-103 N5-gn	153639	25	standard	green POM sleeve	03	
28 S 147-103 N5-ro	153640	25	standard	red POM sleeve	03	
28 S 147-103 N5-sw	153638	25	standard	black POM sleeve	03	

Straight Plug, solder-crimp

Flexible Cables

Rosenberger No.	Order No.	Sales Unit	Packaging	Remarks	Cable Group	
28 S 107-302 N5	156780	50	standard	QLF®	02	
28 S 107-303 N5	183399	50	standard	QLF®	03	
28 S 107-307 N5	147301	25	standard	QLF®	07	

Right Angle Plug, solder-crimp

Flexible Cables

Rosenberger No.	Order No.	Sales Unit	Packaging	Remarks	Cable Group	
28 S 207-302 N5	153274	100	standard	QLF®	02	
28 S 207-303 N5	140441	100	standard	QLF®	03	
28 S 207-307 N5	166159	50	standard	QLF®	07	
28 S 263-303 N5	223005	50	standard	IP 68 (mated pair)	03	
28 S 247-303 N5-bl	147323	25	standard	blue POM sleeve	03	
28 S 247-303 N5-gn	147322	25	standard	green POM sleeve	03	
28 S 247-303 N5-ro	147324	25	standard	red POM sleeve	03	
28 S 247-303 N5-sw	274857	25	standard	black POM sleeve	03	

Panel Jack, solder-crimp, hexagonal flange

Flexible Cables

Rosenberger No.	Order No.	Sales Unit	Packaging	Remarks	Cable Group	
28 K 607-302 N5	156779	50	standard	QLF® hexagonal flange	02	
28 K 607-303 N5	146783	50	standard	QLF® hexagonal flange	03	

Panel Connectors - Coaxial End

Panel Jack, 4-hole flange

Coaxial End

Rosenberger No.	Order No.	Sales Unit	Packaging	Remarks	
28 K 401-500 N5	140444	25	blister	QLF® 4-hole flange 12.7 mm 4 x Ø 2.6 mm	

Panel Jack, hexagonal flange

Coaxial End

Rosenberger No.	Order No.	Sales Unit	Packaging	Remarks	
28 K 601-500 N5	161567	25	blister	QLF® hexagonal flange	

PCB Connectors - SMD

Straight Jack, PCB

SMD

Rosenberger No.	Order No.	Sales Unit	Packaging	Remarks	
28 K 101-40M L5	148878	100	blister	QLF®	

Right Angle Jack, PCB

SMD

Rosenberger No.	Order No.	Sales Unit	Packaging	Remarks	
28 K 201-40M L5	166347	25	blister	QLF®	
28 K 203-40M L5	153611	100	blister	QLF®	

PCB Connectors - Solder Pin

Straight Jack, PCB

Solder Pin

Rosenberger No.	Order No.	Sales Unit	Packaging	Remarks	
28 K 101-400 L5	148877	25	blister	QLF® round pins	

Right Angle Jack, PCB

Solder Pin

Rosenberger No.	Order No.	Sales Unit	Packaging	Remarks	
28 K 201-400 N5	148879	100	blister	QLF® round pins	

Adaptors

Adaptors QMA - QMA

Rosenberger No.	Order No.	Sales Unit	Packaging	Remarks	Return Loss	
28 S 101-S00 N5	147022	1	standard	QMA male - male		
28 S 121-S20 N3	148950	1	standard	QMA male - male calibration adaptor	≥ 32 dB @ DC to 4 GHz ≥ 24 dB @ 4 GHz to 18 GHz	
28 K 101-K00 N5	147023	1	standard	QMA female - female		
28 K 121-K20 N3	148952	1	standard	QMA female - female calibration adaptor	≥ 32 dB @ DC to 4 GHz ≥ 24 dB @ 4 GHz to 18 GHz	
28 S 101-K00 N5	147024	1	standard	QMA male - female		
28 S 121-K20 N3	148951	1	standard	QMA male - female calibration adaptor	≥ 32 dB @ DC to 4 GHz ≥ 24 dB @ 4 GHz to 18 GHz	



Adaptors QMA - SMA

Rosenberger No.	Order No.	Sales Unit	Packaging	Remarks	
28 S 132-S00 N5	157980	1	standard	QMA male - SMA male	
28 S 132-K00 N5	154721	1	standard	QMA male - SMA female	
28 K 132-S00 N5	147025	1	standard	QMA female - SMA male	
28 K 132-K00 N5	156117	1	standard	QMA female - SMA female	



Adaptors QMA - RPC-3.50

Rosenberger No.	Order No.	Sales Unit	Packaging	Remarks	Return Loss	
03 S 128-S20 N3	148944	1	standard	RPC-3.50 male - QMA male, calibration adaptor	≥ 32 dB @ DC to 4 GHz ≥ 24 dB @ 4 GHz to 18 GHz	
03 S 128-K20 N3	148947	1	standard	RPC-3.50 male - QMA female, calibration adaptor	≥ 32 dB @ DC to 4 GHz ≥ 24 dB @ 4 GHz to 18 GHz	
03 K 128-S20 N3	148948	1	standard	RPC-3.50 female - QMA male, calibration adaptor	≥ 32 dB @ DC to 4 GHz ≥ 24 dB @ 4 GHz to 18 GHz	
03 K 128-K20 N3	148949	1	standard	RPC-3.50 female - QMA female, calibration adaptor	≥ 32 dB @ DC to 4 GHz ≥ 24 dB @ 4 GHz to 18 GHz	
03 K 728-S22 S3	147490	1	standard	RPC-3.50 female - QMA male 2-hole flange floating test adaptor	≥ 40 dB @ DC to 2.5 GHz ≥ 28 dB @ 2.5 GHz to 6 GHz ≥ 24 dB @ 6 GHz to 18 GHz	

Adaptors QMA - N 50 Ω

Rosenberger No.	Order No.	Sales Unit	Packaging	Remarks	
28 S 153-K00 N5	166928	1	standard	QMA male - N 50 Ω female	
28 K 153-K00 N5	166457	1	standard	QMA female - N 50 Ω female	

Adaptors QMA - 7-16

Rosenberger No.	Order No.	Sales Unit	Packaging	Remarks	
28 K 160-S00 N5	159005	1	standard	QMA female - 7-16 male	
28 S 160-S00 N5	160223	1	standard	QMA male - 7-16 male	

QMA

Terminations

Termination Plug

Rosenberger No.	Order No.	Sales Unit	Packaging	Remarks	Return Loss	
28 S 1ER-001 N5	161718	50	standard	1 Watt Frequency: DC to 12.4 GHz	≥ 29 dB @ DC to 1 GHz ≥ 21 dB @ 1 GHz to 2.5 GHz ≥ 17 dB @ 2.5 GHz to 12.4 GHz	

Termination Jack

Rosenberger No.	Order No.	Sales Unit	Packaging	Remarks	Return Loss	
28 K 1ER-001 N3	154558	5	standard	1 Watt Frequency: DC to 12.4 GHz	≥ 29 dB @ DC to 1 GHz ≥ 21 dB @ 1 GHz to 2.5 GHz ≥ 17 dB @ 2.5 GHz to 12.4 GHz	

Special Tools

Extraction Tool

Rosenberger No.	Order No.	Sales Unit	Packaging	Remarks	
28 W 001-000	146488	1	standard	extraction tool for QMA Locking Nut	

SMB, SMC, SMG, SSMB, SSMC



Rosenberger provides the following subminiature coaxial connector series for various application fields:

- ▶ SMB connectors:
Snap-on connectors for applications up to 4 GHz
- ▶ SMC connectors:
Screw-on connectors for applications up to 6 GHz
- ▶ SMG connectors:
Slide-on connectors for applications up to 4 GHz
- ▶ SSMB connectors:
Snap-on connectors for applications up to 3 GHz
- ▶ SSMC connectors:
Screw-on connectors for applications up to 6 GHz

Rosenberger bietet eine Reihe von Subminiatur-Koaxial-Steckverbinder-Serien für verschiedene Anwendungsbereiche:

- ▶ SMB-Steckverbinder:
Snap-on Steckverbinder für Anwendungen bis 4 GHz
- ▶ SMC-Steckverbinder:
Schraub-Steckverbinder für Anwendungen bis 6 GHz
- ▶ SMG-Steckverbinder:
Einschub-Steckverbinder für Anwendungen bis 4 GHz
- ▶ SSMB-Steckverbinder:
Snap-on-Steckverbinder für Anwendungen bis 3 GHz
- ▶ SSMC-Steckverbinder:
Schraub-Steckverbinder für Anwendungen bis 6 GHz

SMB 50 Ω

SMC 50 Ω

SMG 50 Ω

SMB 75 Ω

SSMB

SSMC

SMB, SMC, SMG,
SSMB, SSMC



Interface Dimensions SMB 50 Ω

Code 59

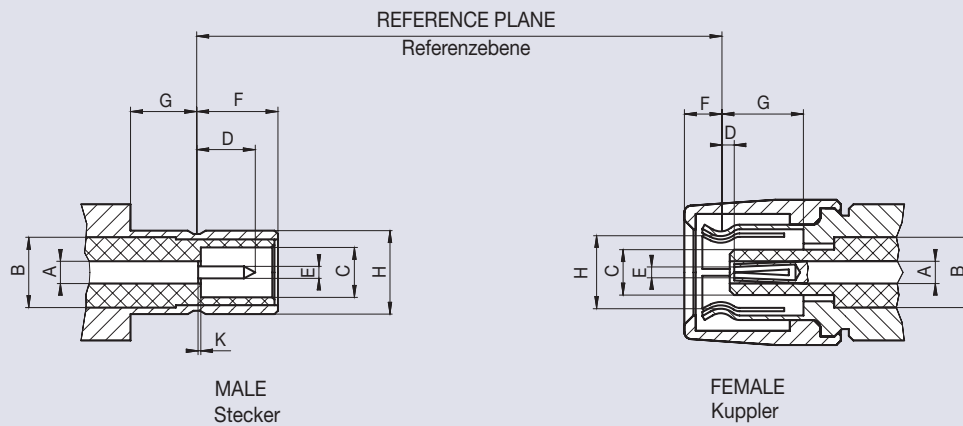

	Male Stecker		Female Kuppler	
	min.	max.	min.	max.
A		²⁾		²⁾
B	Ø 3.05 nom.		Ø 3.05 nom.	
C	Ø 2.08	–	–	Ø 2.06
D	–	2.97	0.18	0.94
E	Ø 0.48	Ø 0.53		¹⁾
F	3.33	3.58	–	1.63
G	1.65	–	3.58	–
H	Ø 3.66	Ø 3.71		¹⁾
K	0.00	0.18	–	–

Dimensions in mm

¹⁾ Resilient, dimension to meet electrical and mechanical requirements

²⁾ Contact diameter refers to 50 Ω

Please note: Rosenberger defines male – female according the design of center contact.

Bitte beachten: Rosenberger definiert die Stecker-Kuppler-Bezeichnung nach der Form des Innenleiters.

Features

- ▶ Interface according to IEC 60169-10, CECC 22130, MIL-PRF-39012
- ▶ Frequency range DC to 4 GHz
- ▶ Return loss (cable connector straight) ≥ 17 dB (typ.)
- ▶ Impedance 50 Ω
- ▶ Snap-on coupling

Product Range

- ▶ Cable connectors
- ▶ PCB connectors
- ▶ Panel connectors
- ▶ Adaptors
- ▶ Terminations

Technical Data SMB 50 Ω

Code 59

Applicable standards Anwendbare Normen	
Interface according to Interface gemäß	IEC 60169-10, CECC 22130, MIL-PRF-39012
Electrical data Elektrische Daten	
Impedance Wellenwiderstand	50 Ω
Frequency range Frequenzbereich	DC to 4 GHz
Return loss (cable connector straight) Rückflusdämpfung (Kabelsteckverbinder gerade)	≥ 17 dB (typ.)
Insertion loss Dämpfung	≤ 0.1 × √f (GHz) dB
Insulation resistance Isolationswiderstand	≥ 1 GΩ
Center contact resistance Übergangswiderstand Innenleiter	≤ 5 mΩ
Outer contact resistance Übergangswiderstand Außenleiter	≤ 2.5 mΩ
Test voltage Prüfspannung	750 V rms
Working voltage Betriebsspannung	250 V rms
Contact current Kontaktstrombelastbarkeit	≤ 1.5 A DC
RF leakage - Interface Schirmdämpfung	≥ 55 dB @ DC to 1 GHz
Mechanical data Mechanische Daten	
Mating cycles Steckzyklen	≥ 500
Center contact captivation Innenleiter Haltekraft	axial: ≥ 10 N
Engagement force Steckkraft	≤ 63 N
Disengagement force Ziehkraft	8 N to 63 N
Environmental data Umweltdaten	
Temperature range Temperaturbereich	-55 °C to +155 °C
Thermal shock Temperaturzyklen	MIL-STD-202, Method 107, Condition B
Corrosion resistance Korrosionsbeständigkeit	MIL-STD-202, Method 101, Condition B
Moisture resistance Feuchtigkeitsbeständigkeit	MIL-STD-202, Method 106
Vibration Vibration	MIL-STD-202, Method 204, Condition B
Max. soldering temperature (PCB connectors) Max. Löttemperatur (Leiterplattensteckverbinder)	IEC 61760-1, +260 °C for 10 sec.
Materials Materialien	
Spring loaded contact parts Federnde Kontaktteile	CuBe, Au plating
Center contact Innenleiter	CuZn, Au plating
Outer contact Außenleiter	CuZn, Au plating
Crimping ferrule Crimphülse	Cu, Au plating
Dielectric Dielektrikum	PTFE
Gasket Dichtung	Rubber

Rosenberger connectors generally fulfill the indicated technical data. Individual values of connectors may deviate depending upon application, design, type of cable, assembly method and workmanship. Data sheets for particular products can be downloaded on our website or can be provided on request from your Rosenberger sales partner.

Rosenberger-Steckverbinder erfüllen grundsätzlich die hier angegebenen technischen Daten. Je nach Anwendung, Bauart, Kabeltyp, Montageart und -ausführung können einzelne Werte der Steckverbinder hiervon abweichen. Datenblätter zu einzelnen Produkten können Sie von unserer Website herunterladen oder auf Anfrage von Ihrem Rosenberger-Ansprechpartner erhalten.

Cable Connectors - Semi-Rigid Cables

Straight Jack, solder

Semi-Rigid Cables

Rosenberger No.	Order No.	Sales Unit	Packaging	Cable Group	
59 K 101-271 L5	171541	100	standard	71	

Right Angle Jack, solder

Semi-Rigid Cables

Rosenberger No.	Order No.	Sales Unit	Packaging	Cable Group	
59 K 214-271 L5	171578	50	standard	71	

Cable Connectors - Flexible Cables

Straight Plug, crimp

Flexible Cables

Rosenberger No.	Order No.	Sales Unit	Packaging	Remarks	Cable Group	
59 S 102-102 L5	171543	50	standard	MIL-PRF-39012/68-0009	02	

Straight Jack, clamp

Flexible Cables

Rosenberger No.	Order No.	Sales Unit	Packaging	Remarks	Cable Group	
59 K 101-001 L5	170629	25	standard	MIL-PRF-39012/67-0003	01	
59 K 101-002 L5	171551	25	standard		02	

Straight Jack, crimp

Flexible Cables

Rosenberger No.	Order No.	Sales Unit	Packaging	Cable Group	
59 K 106-101 L5	170403	100	standard	01	
59 K 106-102 L5	171475	100	standard	02	
59 K 106-103 L5	171568	50	standard	03	

Right Angle Jack, solder-crimp



Flexible Cables

Rosenberger No.	Order No.	Sales Unit	Packaging	Cable Group	
59 K 204-301 L5	104873	50	standard	01	
59 K 214-302 L5	171361	100	standard	02	
59 K 214-303 L5	170630	50	standard	03	

Panel Connectors - Solder End

Panel Plug, hexagonal flange

Solder End

Rosenberger No.	Order No.	Sales Unit	Packaging	Remarks	
59 S 601-200 L5	170631	100	standard	hexagonal flange front mount MIL-PRF-39012/71-0002	
59 S 602-200 L5	171555	100	standard	hexagonal flange rear mount MIL-PRF-39012/71-0001	

SMB, SMC, SMG,
SSMB, SSMC

PCB Connectors - Solder Pin



Straight Plug, PCB

Solder Pin

Rosenberger No.	Order No.	Sales Unit	Packaging	Remarks	
59 S 101-400 L5	170623	300	standard		

Right Angle Plug, PCB

Solder Pin

Rosenberger No.	Order No.	Sales Unit	Packaging	Remarks	
59 S 225-400 L5	246871	100	standard	round pins	
59 S 212-400 L5	171557	50	standard		

Right Angle Plug, PCB, panel mount

Solder Pin

Rosenberger No.	Order No.	Sales Unit	Packaging	Remarks	
59 S 206-400 L5	171556	50	standard	rear mount	

Straight Jack, PCB

Solder Pin

Rosenberger No.	Order No.	Sales Unit	Packaging	Remarks	
59 K 102-400 L5	171558	50	blister		

Adaptors





Adaptors SMB 50 Ω - SMB 50 Ω

Rosenberger No.	Order No.	Sales Unit	Packaging	Remarks	
59 S 101-S00 L5	182492	1	standard	SMB male - male	
59 S 601-S00 L5	182490	1	standard	SMB male - male hexagonal flange	
59 K 101-K00 L5	182485	1	standard	SMB female - female	
59 S 301-S00 L5	107115	1	standard	SMB male - male - male T-adaptor	
59 S 301-K00 L5	103744	1	standard	SMB male - female - male T-adaptor	

Adaptors SMB 50 Ω - SMA

Rosenberger No.	Order No.	Sales Unit	Packaging	Remarks	
59 S 132-S00 L5	108160	1	standard	SMB male - SMA male	
59 S 132-K00 L5	182491	1	standard	SMB male - SMA female	
59 K 132-S00 L5	104605	1	standard	SMB female - SMA male	
59 K 132-K00 L5	182487	1	standard	SMB female - SMA female	

Adaptors SMB 50 Ω - BNC 50 Ω

Rosenberger No.	Order No.	Sales Unit	Packaging	Remarks	
59 S 151-S00 L5	196195	1	standard	SMB male - BNC male	
59 S 151-K00 L5	196194	1	standard	SMB male - BNC female	
59 K 151-S00 L5	104641	1	standard	SMB female - BNC male	
59 K 151-K00 L5	196192	1	standard	SMB female - BNC female	

SMB 50 Ω

Adaptors SMB 50 Ω - N 50 Ω

Rosenberger No.	Order No.	Sales Unit	Packaging	Remarks	
59 S 153-S00 L5	196198	1	standard	SMB male - N male	
59 S 153-K00 L5	196197	1	standard	SMB male - N female	
59 K 153-S00 L5	104667	1	standard	SMB female - N male	
59 K 153-K00 L5	196193	1	standard	SMB female - N female	

Terminations

Termination Plug

Rosenberger No.	Order No.	Sales Unit	Packaging	Remarks	Return Loss	
59 S 15R-001 E3	107877	1	standard	1 Watt Frequency: DC to 6 GHz	≥ 23.1 dB @ DC to 2.5 GHz ≥ 17 dB @ 2.5 GHz to 6 GHz	

Termination Jack

Rosenberger No.	Order No.	Sales Unit	Packaging	Remarks	Return Loss	
59 K 15R-001 E3	136898	1	standard	1 Watt Frequency: DC to 2 GHz	≥ 24.9 dB @ DC to 1 GHz ≥ 20.8 dB @ 1 GHz to 2 GHz	

SMC 50 Ω

Interface Dimensions SMC 50 Ω

Code 39

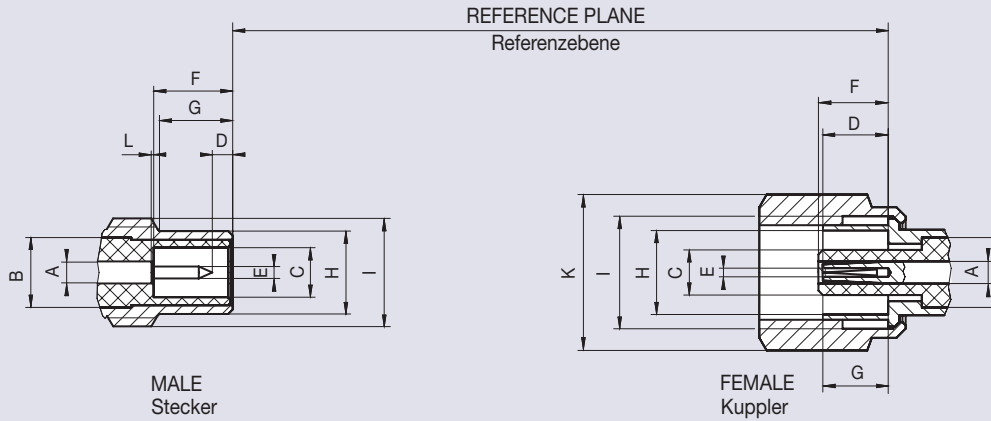

	Male Stecker		Female Kuppler	
	min.	max.	min.	max.
A	2)		2)	
B	–	Ø 3.07	–	Ø 3.07
C	Ø 2.08	–	–	Ø 2.06
D	0.61	–	2.85	3.40
E	Ø 0.48	Ø 0.53	1)	
F	3.40	–	–	3.40
G	3.12	3.38	–	3.10
H	–	Ø 3.71	Ø 3.73	–
I	10-32 UNF-2A		10-32 UNF-2B	
K	–	–	hex 6	
L	0.00	0.18	–	–

Dimensions in mm

¹⁾ Resilient, dimension to meet electrical and mechanical requirements

²⁾ Contact diameter refers to 50 Ω

Features

- ▶ Interface according to IEC 60169-9, CECC 22140, MIL-PRF-39012
- ▶ Frequency range DC to 6 GHz
- ▶ Return loss (cable connector straight) ≥ 20 dB @ 3 GHz
- ▶ Impedance 50 Ω
- ▶ Screw-on coupling

Product Range

- ▶ Cable connectors
- ▶ PCB connectors
- ▶ Panel connectors
- ▶ Adaptors

Technical Data SMC 50 Ω

Code 39

Applicable standards Anwendbare Normen	
Interface according to Interface gemäß	IEC 60169-9, CECC 22140, MIL-PRF-39012
Electrical data Elektrische Daten	
Impedance Wellenwiderstand	50 Ω
Frequency range Frequenzbereich	DC to 6 GHz
Return loss (cable connector straight) Rückflusdämpfung (Kabelsteckverbinder gerade)	≥ 30 dB @ DC to 1 GHz ≥ 20 dB @ 1 GHz to 3 GHz ≥ 18 dB @ 3 GHz to 6 GHz
Insertion loss Dämpfung	≤ 0.1 × √f (GHz) dB
Insulation resistance Isolationswiderstand	≥ 1 GΩ
Center contact resistance Übergangswiderstand Innenleiter	≤ 5 mΩ
Outer contact resistance Übergangswiderstand Außenleiter	≤ 2.5 mΩ
Test voltage Prüfspannung	750 V rms
Working voltage Betriebsspannung	250 V rms
Contact current Kontaktstrombelastbarkeit	≤ 1.5 A DC
RF leakage - Interface Schirmdämpfung	≥ 90 dB @ DC to 1 GHz
Mechanical data Mechanische Daten	
Mating cycles Steckzyklen	≥ 500
Center contact captivation Innenleiter Haltekraft	axial: ≥ 10 N
Coupling test torque Prüfdrehmoment	≤ 0.71 Nm
Coupling torque recommended Drehmoment empfohlen	0.25 Nm to 0.35 Nm
Environmental data Umweltdaten	
Temperature range Temperaturbereich	-55 °C to +155 °C
Thermal shock Temperaturzyklen	MIL-STD-202, Method 107, Condition B
Corrosion resistance Korrosionsbeständigkeit	MIL-STD-202, Method 101, Condition B
Moisture resistance Feuchtigkeitsbeständigkeit	MIL-STD-202, Method 106
Vibration Vibration	MIL-STD-202, Method 204, Condition D
Max. soldering temperature (PCB connectors) Max. Löttemperatur (Leiterplattensteckverbinder)	IEC 61760-1, +260 °C for 10 sec.
Materials Materialien	
Spring loaded contact parts Federnde Kontaktteile	CuBe, Au plating
Center contact Innenleiter	CuZn, Au plating
Outer contact Außenleiter	CuZn, Au plating
Crimping ferrule Crimphülse	Cu, Au plating
Dielectric Dielektrikum	PTFE
Gasket Dichtung	Rubber

Rosenberger connectors generally fulfill the indicated technical data. Individual values of connectors may deviate depending upon application, design, type of cable, assembly method and workmanship. Data sheets for particular products can be downloaded on our website or can be provided on request from your Rosenberger sales partner.

Rosenberger-Steckverbinder erfüllen grundsätzlich die hier angegebenen technischen Daten. Je nach Anwendung, Bauart, Kabeltyp, Montageart und -ausführung können einzelne Werte der Steckverbinder hiervon abweichen. Datenblätter zu einzelnen Produkten können Sie von unserer Website herunterladen oder auf Anfrage von Ihrem Rosenberger-Ansprechpartner erhalten.

Cable Connectors - Semi-Rigid Cables

Panel Plug, solder, round flange

Semi-Rigid Cables

Rosenberger No.	Order No.	Sales Unit	Packaging	Remarks	Cable Group	
39 S 501-271 L5	180222	25	standard	round flange rear mount length 15 mm	71	

Right Angle Jack, solder

Semi-Rigid Cables

Rosenberger No.	Order No.	Sales Unit	Packaging	Cable Group	
39 K 20A-271 L5	180225	25	standard	71	

Cable Connectors - Flexible Cables

Straight Jack, crimp

Flexible Cables

Rosenberger No.	Order No.	Sales Unit	Packaging	Cable Group	
39 K 102-101 L5	141397	25	standard	01	
39 K 102-102 L5	138704	25	standard	02	

Right Angle Jack, solder-crimp

Flexible Cables

Rosenberger No.	Order No.	Sales Unit	Packaging	Cable Group	
39 K 202-301 L5	155428	25	standard	01	
39 K 202-302 L5	107970	25	standard	02	
39 K 202-303 L5	107214	25	standard	03	

SMB, SMC, SMG,
SSMB, SSMC

Panel Connectors - Solder End

Panel Plug, hexagonal flange

Solder End

Rosenberger No.	Order No.	Sales Unit	Packaging	Remarks	
39 S 601-200 L5	180221	25	standard	hexagonal flange front mount	

PCB Connectors - Solder Pin



Straight Plug, PCB

Solder Pin

Rosenberger No.	Order No.	Sales Unit	Packaging		
39 S 101-400 L5	180224	25	blister		

Adaptors

Adaptors SMC - SMA

Rosenberger No.	Order No.	Sales Unit	Packaging	Remarks	
39 S 132-S00 L5	101139	1	standard	SMC male - SMA male	
39 S 132-K00 L5	104040	1	standard	SMC male - SMA female	
39 K 132-K00 L5	180220	1	standard	SMC female - SMA female	

SMB, SMC, SMG,
SSMB, SSMC

SMG 50 Ω

Interface Dimensions SMG 50 Ω

Code 49

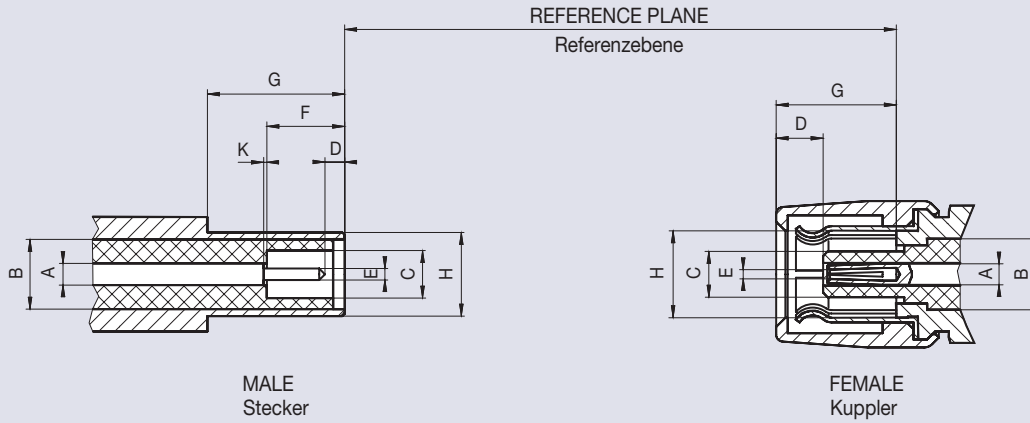

	Male Stecker		Female Kuppler	
	min.	max.	min.	max.
A	2)		2)	
B	Ø 3.05 nom.		Ø 3.05 nom.	
C	Ø 2.08	Ø 2.16	–	Ø 2.06
D	0.61	–	1.81	2.36
E	Ø 0.48	Ø 0.53	1)	
F	3.40	–	–	–
G	6.00	–	–	6.10
H	Ø 3.66	Ø 3.71	1)	
K	0.00	0.18	–	–

Dimensions in mm

¹⁾ Resilient, dimension to meet electrical and mechanical requirements

²⁾ Contact diameter refers to 50 Ω

Features

- ▶ Interface intermateable with SMB connectors
- ▶ Frequency range DC to 4 GHz
- ▶ Return loss (cable connector straight) ≥ 17 dB (typ.)
- ▶ Impedance 50 Ω
- ▶ Slide-on coupling

Product Range

Connectors are available on request

Technical Data SMG 50 Ω

Code 49

Applicable standards Anwendbare Normen	
Interface intermateable with Interface steckkompatibel mit	SMB connectors
Electrical data Elektrische Daten	
Impedance Wellenwiderstand	50 Ω
Frequency range Frequenzbereich	DC to 4 GHz
Return loss (cable connector straight) Rückflusdämpfung (Kabelsteckverbinder gerade)	≥ 17 dB (typ.)
Insertion loss Dämpfung	≤ 0.1 × √f (GHz) dB
Insulation resistance Isolationswiderstand	≥ 1 GΩ
Center contact resistance Übergangswiderstand Innenleiter	≤ 5 mΩ
Outer contact resistance Übergangswiderstand Außenleiter	≤ 2.5 mΩ
Test voltage Prüfspannung	750 V rms
Working voltage Betriebsspannung	250 V rms
Contact current Kontaktstrombelastbarkeit	≤ 1.5 A DC
RF leakage - Interface Schirmdämpfung	≥ 55 dB @ DC to 1 GHz
Mechanical data Mechanische Daten	
Mating cycles Steckzyklen	≥ 500
Center contact captivation Innenleiter Haltekraft	axial: ≥ 10 N
Engagement force Steckkraft	≤ 8 N
Disengagement force Ziehkraft	≥ 3 N
Environmental data Umweltdaten	
Temperature range Temperaturbereich	-55 °C to +155 °C
Thermal shock Temperaturzyklen	MIL-STD-202, Method 107, Condition B
Corrosion resistance Korrosionsbeständigkeit	MIL-STD-202, Method 101, Condition B
Moisture resistance Feuchtigkeitsbeständigkeit	MIL-STD-202, Method 106
Vibration Vibration	MIL-STD-202, Method 204, Condition C
Max. soldering temperature (PCB connectors) Max. Löttemperatur (Leiterplattensteckverbinder)	IEC 61760-1, +260 °C for 10 sec.
Materials Materialien	
Spring loaded contact parts Federnde Kontaktteile	CuBe, Au plating
Center contact Innenleiter	CuZn, Au plating
Outer contact Außenleiter	CuZn, Au plating
Crimping ferrule Crimphülse	Cu, Au plating
Dielectric Dielektrikum	PTFE
Gasket Dichtung	Rubber

Rosenberger connectors generally fulfill the indicated technical data. Individual values of connectors may deviate depending upon application, design, type of cable, assembly method and workmanship. Data sheets for particular products can be downloaded on our website or can be provided on request from your Rosenberger sales partner.

Rosenberger-Steckverbinder erfüllen grundsätzlich die hier angegebenen technischen Daten. Je nach Anwendung, Bauart, Kabeltyp, Montageart und -ausführung können einzelne Werte der Steckverbinder hiervon abweichen. Datenblätter zu einzelnen Produkten können Sie von unserer Website herunterladen oder auf Anfrage von Ihrem Rosenberger-Ansprechpartner erhalten.

SMB 75 Ω

Interface Dimensions SMB 75 Ω

Code 759

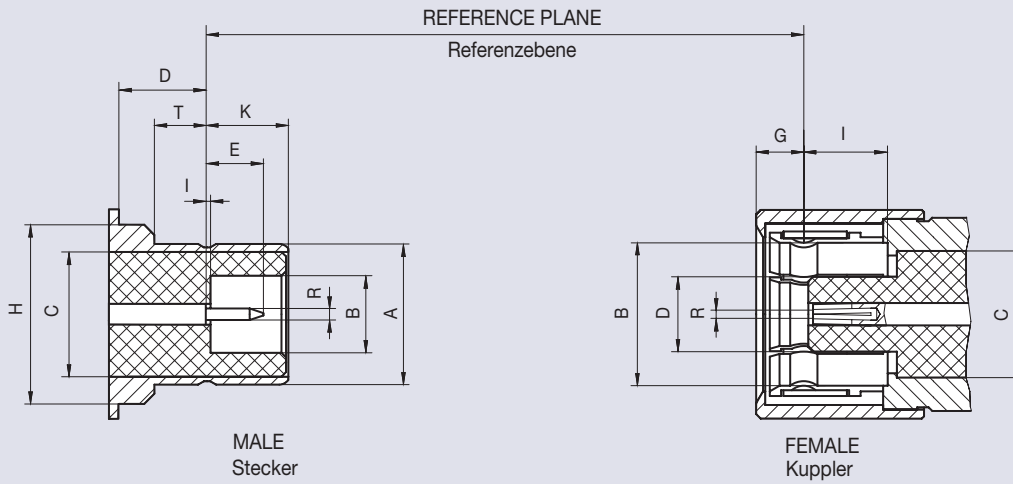

	Male Stecker		Female Kuppler	
	min.	max.	min.	max.
A	Ø 6.20	Ø 6.25	–	–
B	Ø 3.35	–	Ø 6.25	–
C	Ø 5.60 nom.		Ø 5.60 nom.	
D	2.36	–	–	Ø 3.33
E	–	2.97	–	–
G	–	–	–	2.36
H	–	Ø 7.94	–	–
I	–	0.18	3.58	–
K	3.33	3.58	–	–
R	Ø 0.48	Ø 0.53		1)
T	2.01	–	–	–

Dimensions in mm

¹⁾ Resilient, dimension to meet electrical and mechanical requirements

Features

- ▶ Interface similar to BT 43 (BS 9210 F0022)
- ▶ Frequency range DC to 4 GHz
- ▶ Return loss (cable connector straight) ≥ 20 dB (typ.)
- ▶ Impedance 75 Ω
- ▶ Snap-on coupling

Product Range

Connectors are available on request

Technical Data SMB 75 Ω

Code 759

Applicable standards Anwendbare Normen	
Interface similar to Interface ähnlich	BT 43 (BS 9210 F0022)
Electrical data Elektrische Daten	
Impedance Wellenwiderstand	75 Ω
Frequency range Frequenzbereich	DC to 4 GHz
Return loss (cable connector straight) Rückflusdämpfung (Kabelsteckverbinder gerade)	≥ 20 dB (typ.)
Insertion loss Dämpfung	≤ 0.1 × √f (GHz) dB
Insulation resistance Isolationswiderstand	≥ 2 GΩ
Center contact resistance Übergangswiderstand Innenleiter	≤ 5 mΩ
Outer contact resistance Übergangswiderstand Außenleiter	≤ 2.5 mΩ
Test voltage Prüfspannung	750 V rms
Working voltage Betriebsspannung	250 V rms
Contact current Kontaktstrombelastbarkeit	≤ 1.0 A DC
RF leakage - Interface Schirmdämpfung	≥ 70 dB @ DC to 1 GHz
Mechanical data Mechanische Daten	
Mating cycles Steckzyklen	≥ 500
Center contact captivation Innenleiter Haltekraft	axial: ≥ 10 N
Engagement force Steckkraft	8 N to 63 N
Disengagement force Ziehkraft	8 N to 63 N
Environmental data Umweltdaten	
Temperature range Temperaturbereich	-40 °C to +100 °C
Dry heat Trockene Wärme	IEC 60068-2-2
Damp heat Feuchte Wärme	IEC 60068-2-78
Climatic category Klimakategorie	IEC 60068-2-1 40/100/21
Max. soldering temperature (PCB connectors) Max. Löttemperatur (Leiterplattensteckverbinder)	IEC 61760-1, +260 °C for 10 sec.
Materials Materialien	
Spring loaded contact parts Federnde Kontaktteile	CuBe, Au plating
Center contact Innenleiter	CuZn, Au plating
Outer contact Außenleiter	CuZn, Au plating
Crimping ferrule Crimphülse	Cu, Ni plating
Dielectric Dielektrikum	PTFE

Rosenberger connectors generally fulfill the indicated technical data. Individual values of connectors may deviate depending upon application, design, type of cable, assembly method and workmanship. Data sheets for particular products can be downloaded on our website or can be provided on request from your Rosenberger sales partner.

Rosenberger-Steckverbinder erfüllen grundsätzlich die hier angegebenen technischen Daten. Je nach Anwendung, Bauart, Kabeltyp, Montageart und -ausführung können einzelne Werte der Steckverbinder hiervon abweichen. Datenblätter zu einzelnen Produkten können Sie von unserer Website herunterladen oder auf Anfrage von Ihrem Rosenberger-Ansprechpartner erhalten.

Interface Dimensions SSMB

Code 35

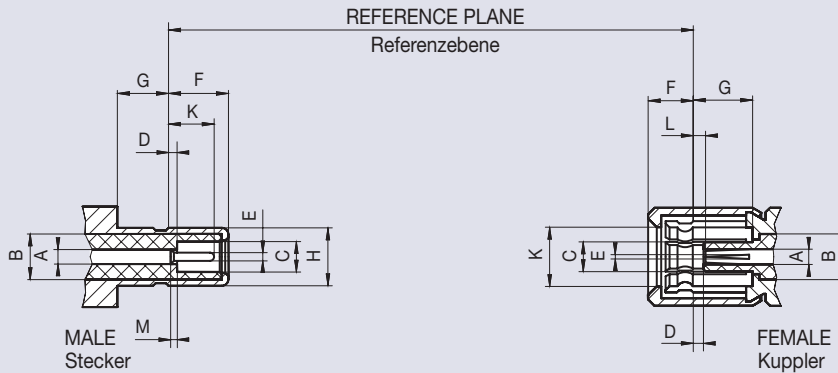

	Male Stecker		Female Kuppler	
	min.	max.	min.	max.
A		¹⁾		¹⁾
B	Ø 2.11 nom.		Ø 2.11 nom.	
C	Ø 1.37	–	–	Ø 1.35
D	–	0.56	0.53	–
E	Ø 0.35	Ø 0.38		²⁾
F	–	2.77	–	2.26
G	2.30	–	2.74	–
H	–	Ø 2.69	–	–
K	–	2.44	Ø 2.74	–
L	–	–	0.53	0.89
M	0.00	0.13	–	–

Dimensions in mm

¹⁾ Contact diameter refers to 50 Ω

²⁾ Resilient, dimension to meet electrical and mechanical requirements

Features

- ▶ Interface according to EN 122170, IEC 60169-19
- ▶ Frequency range DC to 3 GHz
- ▶ Return loss (cable connector straight) ≥ 17 dB (typ.)
- ▶ Impedance 50 Ω
- ▶ Snap-on coupling

Product Range

Connectors are available on request

Technical Data SSMB

Code 35

Applicable standards Anwendbare Normen	
Interface according to Interface gemäß	EN 122170, IEC 61169-19
Electrical data Elektrische Daten	
Impedance Wellenwiderstand	50 Ω
Frequency range Frequenzbereich	DC to 3 GHz
Return loss (cable connector straight) Rückflusdämpfung (Kabelsteckverbinder gerade)	≥ 17 dB (typ.)
Insertion loss Dämpfung	≤ 0.1 × √f (GHz) dB
Insulation resistance Isolationswiderstand	≥ 1 GΩ
Center contact resistance Übergangswiderstand Innenleiter	≤ 5 mΩ
Outer contact resistance Übergangswiderstand Außenleiter	≤ 2.5 mΩ
Test voltage Prüfspannung	500 V rms
Working voltage Betriebsspannung	175 V rms
RF leakage - Interface Schirmdämpfung	≥ 40 dB @ DC to 1 GHz
Mechanical data Mechanische Daten	
Mating cycles Steckzyklen	≥ 500
Center contact captivation Innenleiter Haltekraft	axial: ≥ 8 N
Engagement force Steckkraft	8 N to 27 N
Disengagement force Ziehkraft	8 N to 27 N
Environmental data Umweltdaten	
Temperature range Temperaturbereich	-55 °C to +155 °C
Dry heat Trockene Wärme	IEC 60068-2-2
Damp heat Feuchte Wärme	IEC 60068-2-78
Climatic category Klimakategorie	IEC 60068-2-1 55/155/21
Vibration Vibration	IEC 60068-2-6 (10 Hz to 500 Hz, 98 m/s ²)
Max. soldering temperature (PCB connectors) Max. Löttemperatur (Leiterplattensteckverbinder)	IEC 61760-1, +260 °C for 10 sec.
Materials Materialien	
Spring loaded contact parts Federnde Kontaktteile	CuBe, Au plating
Center contact Innenleiter	CuBe, Au plating
Outer contact Außenleiter	CuZn, Au plating
Crimping ferrule Crimphülse	Cu, Au plating
Dielectric Dielektrikum	PTFE

Rosenberger connectors generally fulfill the indicated technical data. Individual values of connectors may deviate depending upon application, design, type of cable, assembly method and workmanship. Data sheets for particular products can be downloaded on our website or can be provided on request from your Rosenberger sales partner.

Rosenberger-Steckverbinder erfüllen grundsätzlich die hier angegebenen technischen Daten. Je nach Anwendung, Bauart, Kabeltyp, Montageart und -ausführung können einzelne Werte der Steckverbinder hiervon abweichen. Datenblätter zu einzelnen Produkten können Sie von unserer Website herunterladen oder auf Anfrage von Ihrem Rosenberger-Ansprechpartner erhalten.

Interface Dimensions SSMC

Code 38

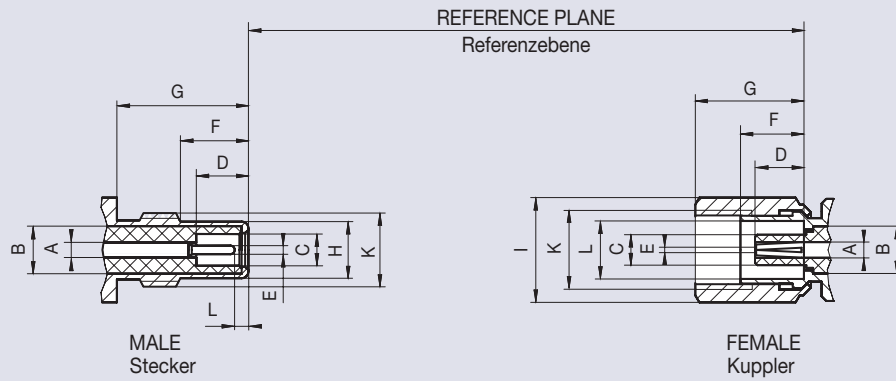

	Male Stecker		Female Kuppler	
	min.	max.	min.	max.
A		¹⁾		¹⁾
B	Ø 2.11 nom.		Ø 2.11 nom.	
C	Ø 1.37	–	–	Ø 1.35
D	2.29	–	–	2.29
E	Ø 0.35	Ø 0.38		²⁾
F	2.94	–	–	2.84
G	5.71	–	–	5.70
H	–	Ø 2.54	–	–
I	–	–		hex 4
K	6-40 UNF-2A		6-40 UNF-2B	
L	–	0.84	2.59	–

Dimensions in mm

¹⁾ Contact diameter refers to 50 Ω

²⁾ Resilient, dimension to meet electrical and mechanical requirements

Features

- ▶ Interface according to EN 122180, IEC 60169-20
- ▶ Frequency range DC to 6 GHz
- ▶ Return loss (cable connector straight) ≥ 16 dB (typ.)
- ▶ Impedance 50 Ω
- ▶ Screw-on coupling

Product Range

Connectors are available on request

Technical Data SSMC

Code 38

Applicable standards Anwendbare Normen	
Interface according to Interface gemäß	EN 122180, IEC 60169-20
Electrical data Elektrische Daten	
Impedance Wellenwiderstand	50 Ω
Frequency range Frequenzbereich	DC to 6 GHz
Return loss (cable connector straight) Rückflusdämpfung (Kabelsteckverbinder gerade)	≥ 16 dB (typ.)
Insertion loss Dämpfung	≤ 0.1 × √f (GHz) dB
Insulation resistance Isolationswiderstand	≥ 1 GΩ
Center contact resistance Übergangswiderstand Innenleiter	≤ 5 mΩ
Outer contact resistance Übergangswiderstand Außenleiter	≤ 2.5 mΩ
Test voltage Prüfspannung	500 V rms
Working voltage Betriebsspannung	175 V rms
RF leakage - Interface Schirmdämpfung	≥ 70 dB @ DC to 1 GHz
Mechanical data Mechanische Daten	
Mating cycles Steckzyklen	≥ 500
Coupling nut retention Überwurfmutter Haltekraft	≥ 100 N
Center contact captivation Innenleiter Haltekraft	axial: ≥ 8 N
Coupling test torque Prüfdrehmoment	≤ 0.3 Nm
Coupling torque recommended Drehmoment empfohlen	0.20 Nm to 0.23 Nm
Environmental data Umweltdaten	
Temperature range Temperaturbereich	-55 °C to +155 °C
Dry heat Trockene Wärme	IEC 60068-2-2
Damp heat Feuchte Wärme	IEC 60068-2-78
Climatic category Klimakategorie	IEC 60068-2-1 55/155/21
Vibration Vibration	IEC 60068-2-6 (10 Hz to 500 Hz, 98 m/s ²)
Max. soldering temperature (PCB connectors) Max. Löttemperatur (Leiterplattensteckverbinder)	IEC 61760-1, +260 °C for 10 sec.
Materials Materialien	
Spring loaded contact parts Federnde Kontaktteile	CuBe, Au plating
Center contact Innenleiter	CuBe, Au plating
Outer contact Außenleiter	CuZn, Au plating
Crimping ferrule Crimphülse	Cu, Au plating
Dielectric Dielektrikum	PTFE

Rosenberger connectors generally fulfill the indicated technical data. Individual values of connectors may deviate depending upon application, design, type of cable, assembly method and workmanship. Data sheets for particular products can be downloaded on our website or can be provided on request from your Rosenberger sales partner.

Rosenberger-Steckverbinder erfüllen grundsätzlich die hier angegebenen technischen Daten. Je nach Anwendung, Bauart, Kabeltyp, Montageart und -ausführung können einzelne Werte der Steckverbinder hiervon abweichen. Datenblätter zu einzelnen Produkten können Sie von unserer Website herunterladen oder auf Anfrage von Ihrem Rosenberger-Ansprechpartner erhalten.

1.6-5.6 1.0-2.3 DIN 47297



1.6.-5.6 and 1.0-2.3 (DIN 47297) connectors are characterized by high mechanical and electrical stability, they are mainly used for reliable transmission of high bit-rates. 1.6.-5.6. connectors, IIrd and IIIrd generations are intermateable, male types can be connected with all female types.

1.6-5.6 und 1.0-2-3 (DIN 47297)-Steckverbinder zeichnen sich durch gute elektrische und mechanische Stabilität aus, Hauptanwendungsgebiet ist die Übertragung hoher Bit-Raten. Steckverbinder der II. und III. Generation sind steckkompatibel, die Stecker-Typen sind mit den Kuppler-Typen koppelbar.

1.6-5.6
1.0-2.3 DIN 47297



1.6-5.6

Interface Dimensions 1.6-5.6

Code 78 / 88

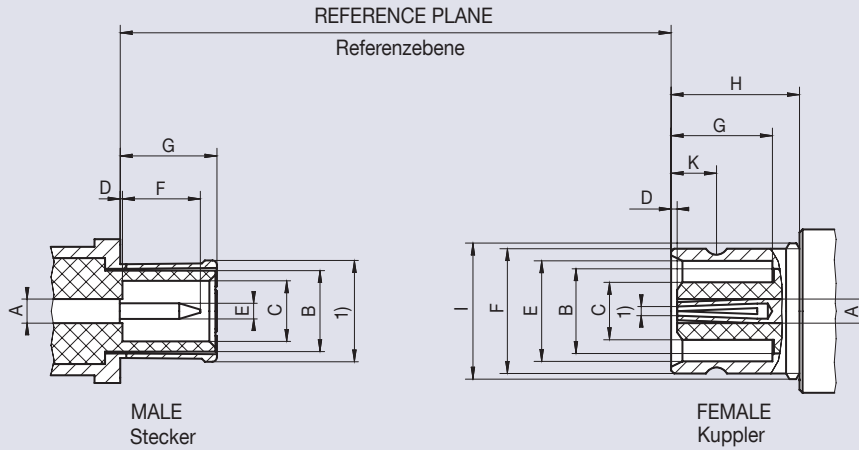

	Male Stecker		Female Kuppler	
	min.	max.	min.	max.
A	Ø 1.60 nom.		Ø 1.60 nom.	
B	Ø 5.60 nom.		Ø 5.60 nom.	
C	Ø 4.00	–	–	Ø 3.80
D	–	0.15	0.25	–
E	Ø 0.97	Ø 1.03	Ø 6.60	Ø 6.69
F	–	5.50	Ø 8.10	Ø 8.25
G	6.40	6.60	6.70	–
H	–	–	9.70	–
I	–	–	M 9 x 0.5	
K	–	–	2.90	3.10

Dimensions in mm

Features

- ▶ Interface according to CECC 22240
- ▶ Frequency range DC to 4 GHz (II. Gen.), DC to 12 GHz (III. Gen.)
- ▶ Return loss (cable connector straight) ≥ 27 dB @ 1 GHz to 2 GHz
- ▶ Impedance 75 Ω

Product Range

- ▶ Cable connectors
- ▶ PCB connectors
- ▶ Adaptors

Coupling mechanisms, male types:

- ▶ Type A: Screw-on coupling
Screwing plug and jack by hand using a coupling nut
- ▶ Type B: Snap-on coupling
Male connector with spring mechanism, snaps into slot on female connector body
- ▶ Type C: Slide-on coupling with centering sleeve
Conical insertion guide of floating male connector facilitates connection to fixed female connectors. The interconnection is a slide fit.
- ▶ Type F: Quick-lock coupling mechanism
Quick-lock coupling mechanism for fast, easy and reliable connections in tightest spaces, assembly tools not necessary.

Technical Data 1.6-5.6

Code 78 / 88

Applicable standards Anwendbare Normen	
Interface according to Interface gemäß	CECC 22240
Electrical data Elektrische Daten	
Impedance Wellenwiderstand	75 Ω
Frequency range Frequenzbereich	DC to 4 GHz (II. generation) DC to 12 GHz (III. generation)
Return loss (cable connector straight) Rückflussdämpfung (Kabelsteckverbinder gerade)	≥ 33 dB @ DC to 1 GHz (III. generation) ≥ 27 dB @ 1 GHz to 2 GHz (III. generation) ≥ 20 dB @ 2 GHz to 4 GHz (III. generation)
Insertion loss Dämpfung	≤ 0.1 x √f (GHz) dB
Insulation resistance Isolationswiderstand	≥ 10 GΩ
Center contact resistance Übergangswiderstand Innenleiter	≤ 4 mΩ
Outer contact resistance Übergangswiderstand Außenleiter	≤ 2 mΩ
Test voltage Prüfspannung	1000 V rms
Working voltage Betriebsspannung	330 V rms
RF leakage - Interface Schirmdämpfung	≥ 100 dB @ DC to 1 GHz (Type A)
Mechanical data Mechanische Daten	
Mating cycles Steckzyklen	≥ 500
Center contact captivation Innenleiter Haltekraft	axial: ≥ 30 N
Engagement force Steckkraft	2.2 N to 12 N (Type A) 18 N to 50 N (Type F)
Disengagement force Ziehkraft	2.2 N to 12 N (Type A) 18 N to 50 N (Type F)
Environmental data Umweltdaten	
Temperature range Temperaturbereich	-40 °C to +85 °C
Dry heat Trockene Wärme	IEC 60068-2-2
Damp heat Feuchte Wärme	IEC 60068-2-78
Climatic category Klimakategorie	IEC 60068-2-1 40/85/21
Vibration Vibration	IEC 60068-2-6 (10 Hz to 2000 Hz, 100 m/s ²)
Max. soldering temperature (PCB connectors) Max. Löttemperatur (Leiterplattensteckverbinder)	IEC 61760-1, +260 °C for 10 sec.
Materials Materialien	
Spring loaded contact parts Federnde Kontaktteile	CuBe / CuSn, Au plating
Center contact Innenleiter	CuZn, Au plating
Outer contact Außenleiter	CuZn, Au plating
Body Gehäuse	CuZn, Ni plating
Crimping ferrule Crimphülse	Cu, white bronze plating
Dielectric Dielektrikum	PTFE (II. generation) LCP or equivalent (III. generation)

Rosenberger connectors generally fulfill the indicated technical data. Individual values of connectors may deviate depending upon application, design, type of cable, assembly method and workmanship. Data sheets for particular products can be downloaded on our website or can be provided on request from your Rosenberger sales partner.

Rosenberger-Steckverbinder erfüllen grundsätzlich die hier angegebenen technischen Daten. Je nach Anwendung, Bauart, Kabeltyp, Montageart und -ausführung können einzelne Werte der Steckverbinder hiervon abweichen. Datenblätter zu einzelnen Produkten können Sie von unserer Website herunterladen oder auf Anfrage von Ihrem Rosenberger-Ansprechpartner erhalten.

Cable Connectors - Flexible Cables

Straight Plug, crimp

Flexible Cables

Rosenberger No.	Order No.	Sales Unit	Packaging	Remarks	Cable Group	
88 S 105-1V2 L5	183742	25	standard	III. generation type A	V2	

Right Angle Plug, solder crimp

Flexible Cables

Rosenberger No.	Order No.	Sales Unit	Packaging	Remarks	Cable Group	
88 S 203-3V2 L5	183750	25	standard	III. generation type A	V2	

Panel Jack, crimp, round flange

Flexible Cables

Rosenberger No.	Order No.	Sales Unit	Packaging	Remarks	Cable Group	
88 K 505-1V2 L5	162067	25	standard	round flange rear mount III. generation	V2	

Right Angle Panel Jack, solder crimp round flange

Flexible Cables

Rosenberger No.	Order No.	Sales Unit	Packaging	Remarks	Cable Group	
88 K 203-302 L5	103557	25	standard	round flange rear mount III. generation	02	
88 K 203-3V2 L5	153451	25	standard	round flange rear mount III. generation	V2	

PCB Connectors - Solder Pin



Straight Jack, PCB

Solder Pin

Rosenberger No.	Order No.	Sales Unit	Packaging	Remarks		
78 K 104-400 L5	103671	50	blister	II. generation		

Adaptors

Adaptors 1.6-5.6 - 1.6-5.6

Rosenberger No.	Order No.	Sales Unit	Packaging	Remarks	
78 K 102-K00 L5	108617	10	standard	1.6-5.6 female - female II. generation round flange	
78 S 301-K00 L5	140268	1	standard	1.6-5.6 male - female - male II. generation type A Y-adaptor	

Adaptors 1.6-5.6 - BNC 75 Ω

Rosenberger No.	Order No.	Sales Unit	Packaging	Remarks	
88 S 171-S00 L5	100625	1	standard	1.6-5.6 male III. generation type A - BNC 75 Ω male	
88 S 171-K00 L5	182694	1	standard	1.6-5.6 male III. generation type A - BNC 75 Ω female	
88 K 171-K00 L5	103048	1	standard	1.6-5.6 female III. generation - BNC 75 Ω female round flange	
71 S 188-K00 L5	107786	1	standard	BNC 75 Ω male - 1.6-5.6 female III. generation	

1.0-2.3 DIN 47297 50 Ω

Interface Dimensions 1.0-2.3 DIN 47297 50 Ω

Code 34

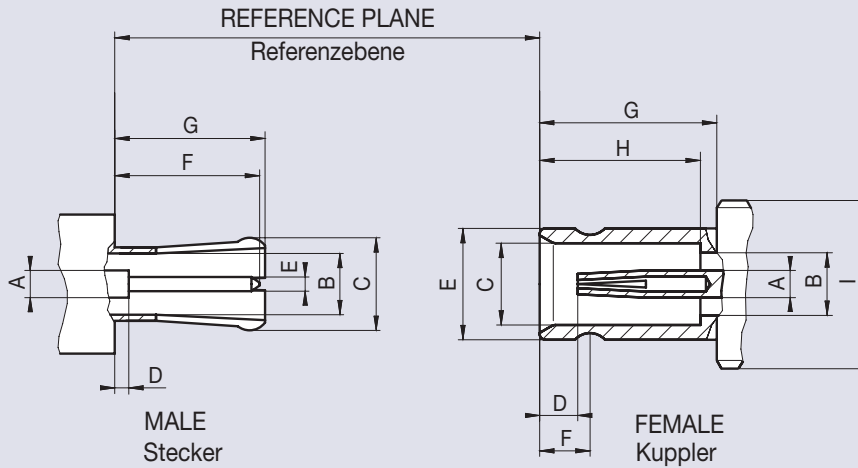

	Male Stecker		Female Kuppler	
	min.	max.	min.	max.
A	Ø 1.00 nom.		Ø 1.00 nom. ^{1) 2)}	
B	–	Ø 2.30 nom. ¹⁾	–	Ø 2.30 nom.
C	²⁾		Ø 3.00	Ø 3.06
D	–	1.15	1.15	1.75
E	Ø 0.475	Ø 0.52	Ø 4.03	Ø 4.15
F	–	5.50	1.80	1.90
G	5.40	5.70	6.40	6.50
H	–	–	5.80	5.90
I	–	–	M 5.5 x 0.5	

Dimensions in mm

¹⁾ Contact diameter refers to 50 Ω

²⁾ Resilient, dimension to meet electrical and mechanical requirements

Features

- ▶ Interface according to CECC 22230, DIN 47297
- ▶ Frequency range DC to 10 GHz
- ▶ Return loss (cable connector straight) ≥ 23 dB @ 1 GHz to 4 GHz
- ▶ Impedance 50 Ω
- ▶ 40% size reduction compared to 1.6-5.6 connectors

Product Range

Connectors are available on request

Coupling mechanisms, male types:

- ▶ Type A: Screw-on coupling
Screwing plug and jack by hand with a coupling nut.
- ▶ Type C: Slide-on coupling with centering sleeve
Conical insertion guide of floating male connector facilitates connection to fixed female connectors. The interconnection is a slide fit.
- ▶ Type E: Slide-on coupling with retention clip
For use in multiple or mixed connector housings. In contrast to type C, additional retention clip. The interconnection is a slide fit.
- ▶ Type F: Quick-lock coupling mechanism
Quick-lock coupling mechanism for fast, easy and reliable connections in tightest spaces, assembly tools are not necessary.

Technical Data 1.0-2.3 DIN 47297 50 Ω

Code 34

Applicable standards Anwendbare Normen	
Interface according to Interface gemäß	CECC 22230, DIN 47297
Electrical data Elektrische Daten	
Impedance Wellenwiderstand	50 Ω
Frequency range Frequenzbereich	DC to 10 GHz (max.) DC to 2.5 GHz (opt.)
Return loss (cable connector straight) Rückflussdämpfung (Kabelsteckverbinder gerade)	≥ 32 dB @ DC to 1 GHz ≥ 23 dB @ 1 GHz to 4 GHz ≥ 16 dB @ 4 GHz to 10 GHz
Insertion loss Dämpfung	≤ 0.1 x √f (GHz) dB
Insulation resistance Isolationswiderstand	≥ 1 GΩ
Center contact resistance Übergangswiderstand Innenleiter	≤ 4 mΩ
Outer contact resistance Übergangswiderstand Außenleiter	≤ 2.5 mΩ
Test voltage Prüfspannung	750 V rms
Working voltage Betriebsspannung	250 V rms
RF leakage - Interface Schirmdämpfung	≥ 90 dB @ DC to 1 GHz
Mechanical data Mechanische Daten	
Mating cycles Steckzyklen	≥ 500
Center contact captivation Innenleiter Haltekraft	axial: ≥ 10 N
Engagement force Steckkraft	≤ 10 N
Disengagement force Ziehkraft	≤ 10 N
Environmental data Umweltdaten	
Temperature range Temperaturbereich	-40 °C to +85 °C
Dry heat Trockene Wärme	IEC 60068-2-2
Damp heat Feuchte Wärme	IEC 60068-2-78
Climatic category Klimakategorie	IEC 60068-2-1 40/85/21
Vibration Vibration	IEC 60068-2-6 (10 Hz to 2000 Hz, 100 m/s ²)
Max. soldering temperature (PCB connectors) Max. Löttemperatur (Leiterplattensteckverbinder)	IEC 61760-1, +260 °C for 10 sec.
Materials Materialien	
Spring loaded contact parts Federnde Kontaktteile	CuBe, Au plating
Center contact Innenleiter	CuZn, Au plating
Outer contact Außenleiter	CuZn, Au plating
Body Gehäuse	CuZn, Ag / Ni plating
Crimping ferrule Crimphülse	Cu, white bronze plating
Dielectric Dielektrikum	PTFE

Rosenberger connectors generally fulfill the indicated technical data. Individual values of connectors may deviate depending upon application, design, type of cable, assembly method and workmanship. Data sheets for particular products can be downloaded on our website or can be provided on request from your Rosenberger sales partner.

Rosenberger-Steckverbinder erfüllen grundsätzlich die hier angegebenen technischen Daten. Je nach Anwendung, Bauart, Kabeltyp, Montageart und -ausführung können einzelne Werte der Steckverbinder hiervon abweichen. Datenblätter zu einzelnen Produkten können Sie von unserer Website herunterladen oder auf Anfrage von Ihrem Rosenberger-Ansprechpartner erhalten.

1.0-2.3 DIN 47297 75 Ω

Interface Dimensions 1.0-2.3 DIN 47297 75 Ω

Code 734

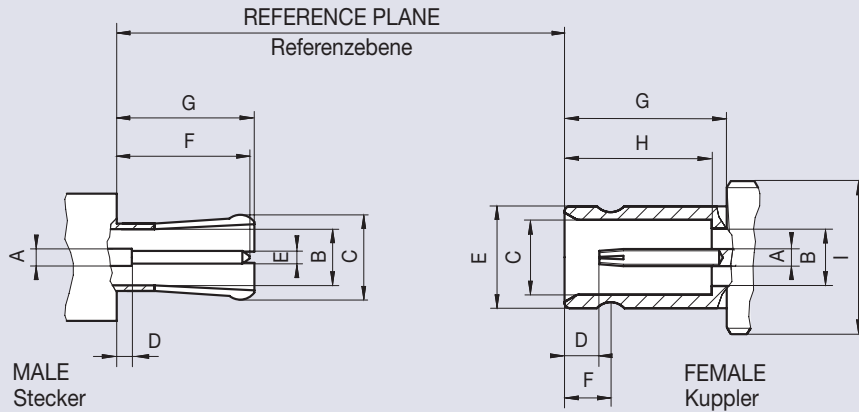

	Male Stecker		Female Kuppler	
	min.	max.	min.	max.
A	Ø 0.70 nom.		Ø 0.70 nom. ^{1) 2)}	
B	-	Ø 2.30 nom. ¹⁾	-	Ø 2.30 nom.
C	²⁾		Ø 3.00	Ø 3.06
D	-	1.15	1.15	1.75
E	Ø 0.475	Ø 0.52	Ø 4.03	Ø 4.15
F	-	5.50	1.80	1.90
G	5.40	5.70	6.40	6.50
H	-	-	5.80	5.90
I	-	-	M 5.5 x 0.5	

Dimensions in mm

¹⁾ Contact diameter refers to 50 Ω

²⁾ Resilient, dimension to meet electrical and mechanical requirements

Features

- ▶ Interface according to CECC 22230, DIN 47297
- ▶ Frequency range DC to 2 GHz
- ▶ Return loss (cable connector straight) ≥ 20 dB (typ.)
- ▶ Impedance 75 Ω
- ▶ 40% size reduction compared to 1.6-5.6 connectors

Product Range

Connectors are available on request

Coupling mechanisms, male types:

- ▶ Type A: Screw-on coupling
Screwing plug and jack by hand with a coupling nut.
- ▶ Type C: Slide-on coupling with centering sleeve
Conical insertion guide of floating male connector facilitates connection to fixed female connectors. The interconnection is a slide fit.
- ▶ Type E: Slide-on coupling with retention clip
For use in multiple or mixed connector housings. In contrast to type C, additional retention clip. The interconnection is a slide fit.
- ▶ Type F: Quick-lock coupling mechanism
Quick-lock coupling mechanism for fast, easy and reliable connections in tightest spaces, assembly tools are not necessary.

Technical Data 1.0-2.3 DIN 47297 75 Ω

Code 734

Applicable standards Anwendbare Normen	
Interface according to Interface gemäß	CECC 22230, DIN 47297
Electrical data Elektrische Daten	
Impedance Wellenwiderstand	75 Ω
Frequency range Frequenzbereich	DC to 2 GHz (max.)
Return loss (cable connector straight) Rückflusdämpfung (Kabelsteckverbinder gerade)	≥ 20 dB (typ.)
Insertion loss Dämpfung	≤ 0.1 × √f (GHz) dB
Insulation resistance Isolationswiderstand	≥ 2 GΩ
Center contact resistance Übergangswiderstand Innenleiter	≤ 4 mΩ
Outer contact resistance Übergangswiderstand Außenleiter	≤ 2.5 mΩ
Test voltage Prüfspannung	750 V rms
Working voltage Betriebsspannung	250 V rms
RF leakage - Interface Schirmdämpfung	≥ 90 dB @ DC to 1 GHz
Mechanical data Mechanische Daten	
Mating cycles Steckzyklen	≥ 500
Center contact captivation Innenleiter Haltekraft	axial: ≥ 10 N
Engagement force Steckkraft	≤ 10 N
Disengagement force Ziehkraft	≤ 10 N
Environmental data Umweltdaten	
Temperature range Temperaturbereich	-40 °C to +85 °C
Dry heat Trockene Wärme	IEC 60068-2-2
Damp heat Feuchte Wärme	IEC 60068-2-78
Climatic category Klimakategorie	IEC 60068-2-1 40/85/21
Vibration Vibration	IEC 60068-2-6 (10 Hz to 2000 Hz, 100 m/s ²)
Max. soldering temperature (PCB connectors) Max. Löttemperatur (Leiterplattensteckverbinder)	IEC 61760-1, +260 °C for 10 sec.
Materials Materialien	
Spring loaded contact parts Federnde Kontaktteile	CuBe, Au plating
Center contact Innenleiter	CuZn, Au plating
Outer contact Außenleiter	CuZn, Au plating
Body Gehäuse	CuZn, Ag / Ni plating
Crimping ferrule Crimphülse	Cu, white bronze plating
Dielectric Dielektrikum	PTFE

Rosenberger connectors generally fulfill the indicated technical data. Individual values of connectors may deviate depending upon application, design, type of cable, assembly method and workmanship. Data sheets for particular products can be downloaded on our website or can be provided on request from your Rosenberger sales partner.

Rosenberger-Steckverbinder erfüllen grundsätzlich die hier angegebenen technischen Daten. Je nach Anwendung, Bauart, Kabeltyp, Montageart und -ausführung können einzelne Werte der Steckverbinder hiervon abweichen. Datenblätter zu einzelnen Produkten können Sie von unserer Website herunterladen oder auf Anfrage von Ihrem Rosenberger-Ansprechpartner erhalten.

Inserts: 1.0-2.3, 08.-2.7 DIN 41626, D-Sub, High Voltage & Power, Mini-Coax



Rosenberger provides a variety of coaxial inserts, high voltage and high power inserts. Due to their small dimensions, high packing densities are possible. A part of these products are designed as reverse polarity versions.

Für Anwendungen in verschiedenen Mischleisten bietet Rosenberger eine Vielzahl an Koaxial-Einsätzen, Hochstrom- und Hochspannungs-Einsätzen, die aufgrund ihrer geringen Abmessungen hohe Packungsdichten erlauben. Ein Teil der Produkte wird als Reverse Polarity-Ausführung angeboten.

1.0-2.3 DIN 41626 50 Ω , 75 Ω

0.8-2.7 75 Ω

D-Sub

Power (DIN, D-Sub)

High Voltage DIN

Mini-Coax



Inserts Coax 1.0-2.3 DIN 41626-T2 50 Ω

Interface Dimensions Inserts Coax 1.0-2.3 DIN 41626-T2 50 Ω

Code 45

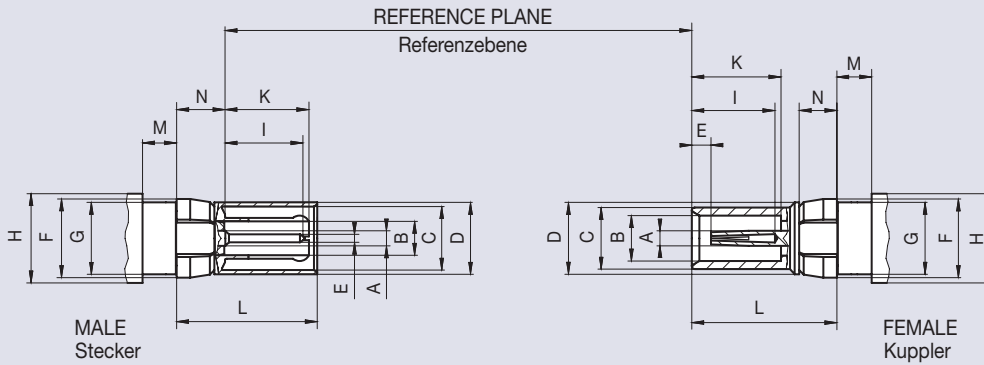

	Male Stecker		Female Kuppler	
	min.	max.	min.	max.
A	Ø 1.00 nom.		Ø 1.00 nom. ^{1) 2)}	
B	–	Ø 2.30 ^{1) 2)}	Ø 3.00	Ø 3.06
C	Ø 4.20	Ø 4.275	Ø 4.03	Ø 4.15
D	Ø 4.66	Ø 4.72	Ø 4.72	Ø 4.75
E	Ø 0.475	Ø 0.52	1.15	1.45
F	–	Ø 5.25	–	Ø 5.25
G	Ø 4.76	Ø 4.79	Ø 4.76	Ø 4.79
H	–	Ø 6.00	–	Ø 6.00 ³⁾
I	5.20	5.50	5.50	–
K	5.40	5.70	5.80	5.90
L	9.25	9.35	9.50	9.60
M	2.22	2.40	2.22	2.40
N	3.05	3.20	2.45	2.50

Dimensions in mm

¹⁾ Contact diameter refers to 50 Ω

²⁾ Resilient, dimension to meet electrical and mechanical requirements

³⁾ Square shape optional

1.0-2.3 DIN 41626 Coax Inserts are designed for use in mixed card edge connections in accordance to DIN 41612. The maximum frequency is approximately 2 GHz, small dimensions enable high packaging densities. The contacts are installed by snap-in method, a combination with high current and high voltage connectors is possible.

1.0-2.3 DIN 41626 Coax-Einsätze sind für den Einsatz in Mischleisten nach DIN 41612 ausgelegt. Die maximale Frequenz liegt bei 2 GHz, die geringe Baugröße ermöglicht hohe Packungsdichten. Die Montage in Leisten erfolgt durch Einrasten, eine Kombination mit Hochstrom- und Hochspannungs-Steckverbindern ist möglich.

Features

- ▶ Interface according to DIN 41626-T2, BS 9525 F0011
- ▶ Frequency range DC to 2 GHz
- ▶ Return loss (cable connector straight) ≥ 20 dB (typ.)
- ▶ Impedance 50 Ω
- ▶ Plug-in/Snap-in DIN 41612 chassis

Product Range

- ▶ Cable connectors
- ▶ PCB connectors
- ▶ Adaptors
- ▶ Extraction tools

Technical Data Inserts Coax 1.0-2.3 DIN 41626-T2 50 Ω

Code 45

Applicable standards Anwendbare Normen	
Interface according to Interface gemäß	DIN 41626-T2, BS 9525 F0011
Electrical data Elektrische Daten	
Impedance Wellenwiderstand	50 Ω
Frequency range Frequenzbereich	DC to 2 GHz
Return loss (cable connector straight) Rückflusdämpfung (Kabelsteckverbinder gerade)	≥ 20 dB (typ.)
Insertion loss Dämpfung	≤ 0.1 × √f (GHz) dB
Insulation resistance Isolationswiderstand	≥ 0.2 GΩ
Center contact resistance Übergangswiderstand Innenleiter	≤ 10 mΩ
Outer contact resistance Übergangswiderstand Außenleiter	≤ 3 mΩ
Test voltage Prüfspannung	750 V rms
Working voltage Betriebsspannung	250 V rms
RF leakage - Interface Schirmdämpfung	≥ 80 dB @ DC to 0.5 GHz ≥ 65 dB @ 0.5 GHz to 1.5 GHz
Mechanical data Mechanische Daten	
Mating cycles Steckzyklen	≥ 500
Connector captivation in plastic Haltekraft des Steckverbinders in Kunststoff	≥ 52 N
Center contact captivation Innenleiter Haltekraft	axial: ≥ 10 N
Engagement force Steckkraft	≤ 10 N
Disengagement force Ziehkraft	≤ 10 N
Environmental data Umweltdaten	
Temperature range Temperaturbereich	-55 °C to +125 °C
Dry heat Trockene Wärme	IEC 60068-2-2
Damp heat Feuchte Wärme	IEC 60068-2-78
Climatic category Klimakategorie	IEC 60068-2-1 55/125/21
Max. soldering temperature (PCB connectors) Max. Löttemperatur (Leiterplattensteckverbinder)	IEC 61760-1, +260 °C for 10 sec.
Materials Materialien	
Spring loaded contact parts Federnde Kontaktteile	CuBe, Au plating
Center contact Innenleiter	CuZn, Au plating
Outer contact Außenleiter	CuZn, Au plating
Crimping ferrule Crimphülse	Cu, Au plating
Clip Clip	CuBe, Ni plating
Dielectric Dielektrikum	PTFE

Rosenberger connectors generally fulfill the indicated technical data. Individual values of connectors may deviate depending upon application, design, type of cable, assembly method and workmanship. Data sheets for particular products can be downloaded on our website or can be provided on request from your Rosenberger sales partner.

Rosenberger-Steckverbinder erfüllen grundsätzlich die hier angegebenen technischen Daten. Je nach Anwendung, Bauart, Kabeltyp, Montageart und -ausführung können einzelne Werte der Steckverbinder hiervon abweichen. Datenblätter zu einzelnen Produkten können Sie von unserer Website herunterladen oder auf Anfrage von Ihrem Rosenberger-Ansprechpartner erhalten.

Inserts Coax 1.0-2.3 DIN 41626-T2 50 Ω

Cable Connectors - Semi-Rigid Cables

Straight Jack, solder

Semi-Rigid Cables

Rosenberger No.	Order No.	Sales Unit	Packaging	Cable Group	
45 K 102-271 L5	106603	50	standard	71	

Cable Connectors - Flexible Cables

Straight Plug, crimp

Flexible Cables

Rosenberger No.	Order No.	Sales Unit	Packaging	Cable Group	
45 S 105-101 L5	184381	50	standard	01	
45 S 101-102 L5	188873	50	standard	02	
45 S 101-103 L5	188901	50	standard	03	

Right Angle Plug, solder-crimp

Flexible Cables

Rosenberger No.	Order No.	Sales Unit	Packaging	Cable Group	
45 S 201-301 L5	103698	25	standard	01	
45 S 201-302 L5	188987	50	standard	02	
45 S 201-303 L5	106449	50	standard	03	

Straight Jack, crimp

Flexible Cables

Rosenberger No.	Order No.	Sales Unit	Packaging	Cable Group	
45 K 101-102 L5	100242	50	standard	02	
45 K 101-103 L5	188650	50	standard	03	

PCB Connectors - Solder Pin

Straight Plug, PCB

Solder Pin

Rosenberger No.	Order No.	Sales Unit	Packaging	Remarks	
45 S 106-400 L5	152156	50	blister	round pins	

Right Angle Plug, PCB

Solder Pin

Rosenberger No.	Order No.	Sales Unit	Packaging	Remarks	
45 S 201-400 L5	150669	50	blister	round pins	

Right Angle Jack, PCB

Solder Pin

Rosenberger No.	Order No.	Sales Unit	Packaging	Remarks	
45 K 201-400 L5	106220	100	blister	round pins	

Inserts Coax 1.0-2.3 DIN 41626-T2 50 Ω



Adaptors

Adaptors 1.0-2.3 DIN 41626 - SMA

Rosenberger No.	Order No.	Sales Unit	Packaging	Remarks	
32 K 145-S00 L5	103442	1	standard	SMA female - 1.0-2.3 DIN 41626 male	

Special Tools

Extraction Tools

Rosenberger No.	Order No.	Sales Unit	Packaging	Remarks	
11 W 102-000	104300	1	standard	extraction tool for DIN 41626 inserts	
11 W 102-001	108279	1	standard	replacement sleeve for extraction tool 11W102-000	

Inserts Coax 1.0-2.3 75 Ω, interm. 50 Ω

Interface Dimensions Inserts Coax 1.0-2.3 75 Ω, interm. 50 Ω

Code 75

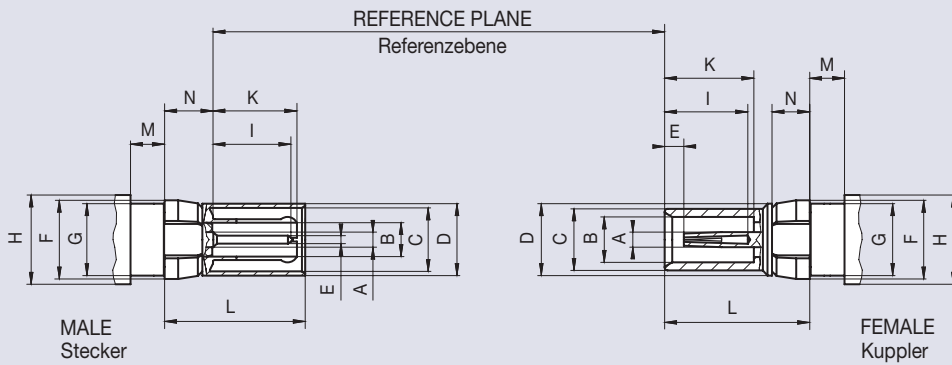

	Male Stecker		Female Kuppler	
	min.	max.	min.	max.
A	–	Ø 1.00	–	Ø 1.00 ^{1) 2)}
B	–	Ø 2.30 ^{1) 2)}	Ø 3.00	Ø 3.06
C	Ø 4.20	Ø 4.275	Ø 4.03	Ø 4.15
D	Ø 4.66	Ø 4.72	Ø 4.72	Ø 4.75
E	Ø 0.475	Ø 0.52	1.15	1.45
F	–	Ø 5.25	–	Ø 5.25
G	Ø 4.76	Ø 4.79	Ø 4.76	Ø 4.79
H	–	Ø 6.00	–	Ø 6.00 ³⁾
I	5.20	5.50	5.50	–
K	5.40	5.70	5.80	5.90
L	9.25	9.35	9.50	9.60
M	2.22	2.40	2.22	2.40
N	3.05	3.20	2.45	2.50

Dimensions in mm

¹⁾ Contact diameter refers to 75 Ω

²⁾ Resilient, dimension to meet electrical and mechanical requirements

³⁾ Square shape optional

1.0-2.3 Coax Inserts, 75 Ω, are similar to DIN 41626-T2 and are designed for use in mixed card edge connections in accordance to DIN 41612. The maximum frequency is approx. 1.5 GHz, small dimensions enable high packing densities. The contacts are installed by snap-in method, a combination with high current and high voltage connectors is possible. 50 Ω and 75 Ω versions are intermateable.

Die 75 Ω -Ausführungen sind ähnlich der Norm DIN 41626-T2 und für den Einsatz in Mischleisten, ähnlich DIN 41612, ausgelegt. Die max. Frequenz liegt bei 1,5 GHz, die geringe Baugröße ermöglicht hohe Packungsdichten. Die Montage in Leisten erfolgt durch Einrasten, eine Kombination mit Hochstrom- und Hochspannungs-Steckverbindern ist möglich. 50 Ω und 75 Ω -Ausführungen sind steckkompatibel.

Features

- ▶ Interface according to DIN 41626-T2 (intermateable with 50 Ω)
- ▶ Frequency range DC to 1.5 GHz
- ▶ Return loss (cable connector straight) ≥ 20 dB (typ.)
- ▶ Impedance 50 Ω
- ▶ Plug-in/Snap-in DIN 41612 chassis

Product Range

Connectors are available on request

Technical Data Inserts Coax 1.0-2.3 75 Ω, interm. 50 Ω

Code 75

Applicable standards Anwendbare Normen	
Interface according to Interface gemäß	DIN 41626-T2 (intermateable with 50 Ω)
Electrical data Elektrische Daten	
Impedance Wellenwiderstand	75 Ω
Frequency range Frequenzbereich	DC to 1.5 GHz
Return loss (cable connector straight) Rückflusdämpfung (Kabelsteckverbinder gerade)	≥ 20 dB (typ.)
Insertion loss Dämpfung	≤ 0.1 × √f (GHz) dB
Insulation resistance Isolationswiderstand	≥ 0.2 GΩ
Center contact resistance Übergangswiderstand Innenleiter	≤ 10 mΩ
Outer contact resistance Übergangswiderstand Außenleiter	≤ 3 mΩ
Test voltage Prüfspannung	750 V rms
Working voltage Betriebsspannung	250 V rms
RF leakage - Interface Schirmdämpfung	≥ 80 dB @ DC to 0.5 GHz ≥ 65 dB @ 0.5 GHz to 1.5 GHz
Mechanical data Mechanische Daten	
Mating cycles Steckzyklen	≥ 500
Connector captivation in plastic Haltekraft des Steckverbinders in Kunststoff	≥ 52 N
Center contact captivation Innenleiter Haltekraft	axial: ≥ 10 N
Engagement force Steckkraft	≤ 10 N
Disengagement force Ziehkraft	≤ 10 N
Environmental data Umweltdaten	
Temperature range Temperaturbereich	-55 °C to +125 °C
Dry heat Trockene Wärme	IEC 60068-2-2
Damp heat Feuchte Wärme	IEC 60068-2-78
Climatic category Klimakategorie	IEC 60068-2-1 55/125/21
Max. soldering temperature (PCB connectors) Max. Löttemperatur (Leiterplattensteckverbinder)	IEC 61760-1, +260 °C for 10 sec.
Materials Materialien	
Spring loaded contact parts Federnde Kontaktteile	CuBe, Au plating
Center contact Innenleiter	CuZn, Au plating
Outer contact Außenleiter	CuZn, Au plating
Crimping ferrule Crimphülse	Cu, Au plating
Clip Clip	CuBe, Ni plating
Dielectric Dielektrikum	PTFE

Rosenberger connectors generally fulfill the indicated technical data. Individual values of connectors may deviate depending upon application, design, type of cable, assembly method and workmanship. Data sheets for particular products can be downloaded on our website or can be provided on request from your Rosenberger sales partner.

Rosenberger-Steckverbinder erfüllen grundsätzlich die hier angegebenen technischen Daten. Je nach Anwendung, Bauart, Kabeltyp, Montageart und -ausführung können einzelne Werte der Steckverbinder hiervon abweichen. Datenblätter zu einzelnen Produkten können Sie von unserer Website herunterladen oder auf Anfrage von Ihrem Rosenberger-Ansprechpartner erhalten.

Inserts Coax 0.8-2.7 DIN 41626-T2 75 Ω

Interface Dimensions Inserts Coax 0.8-2.7 DIN 41626-T2 75 Ω

Code 745

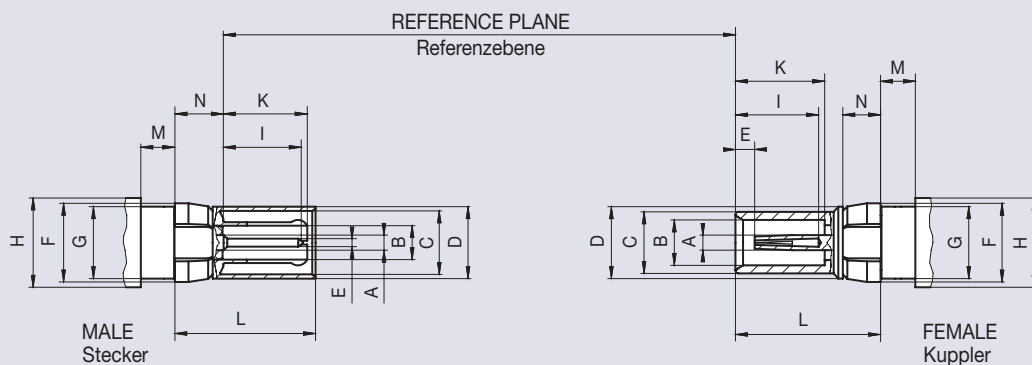

	Male Stecker		Female Kuppler	
	min.	max.	min.	max.
A	–	Ø 0.77	–	Ø 0.77 ^{1) 2)}
B	–	Ø 2.70 ^{1) 2)}	Ø 3.35	Ø 3.38
C	Ø 4.35	Ø 4.38	Ø 4.30	Ø 4.33
D	Ø 4.76	Ø 4.79	Ø 4.72	Ø 4.75
E	Ø 0.37	Ø 0.41	1.15	1.45
F	–	Ø 5.25	–	Ø 5.25
G	Ø 4.76	Ø 4.79	Ø 4.76	Ø 4.79
H	–	Ø 6.00 ³⁾	–	Ø 6.00 ³⁾
I	5.20	5.50	5.50	–
K	5.40	5.70	5.80	5.90
L	9.25	9.35	9.50	9.60
M	2.22	2.40	2.22	2.40
N	2.45	2.50	2.45	2.50

Dimensions in mm

¹⁾ Contact diameter refers to 75 Ω

²⁾ Resilient, dimension to meet electrical and mechanical requirements

³⁾ Square shape optional

0.8-2.7 Coax Inserts, 75 Ω are similar to DIN 41626-T2 and are designed for use in mixed card edge connections in accordance to DIN 41612. The maximum frequency is approx. 1.5 GHz, small dimensions enable high packing densities. The contacts are installed by snap-in method, a combination with high current and high voltage connectors is possible. 50 Ω and 75 Ω versions are intermateable.

0.8-2.7 Koax-Einsätze in 75 Ω sind ähnlich der Norm DIN 41626-T2 und für den Einsatz in Mischleisten nach DIN 41612 ausgelegt. Die max. Frequenz liegt bei 1,5 GHz, die geringe Baugröße ermöglicht hohe Packungsdichten. Die Montage in Leisten erfolgt durch Einrasten, eine Kombination mit Hochstrom- und Hochspannungs-Steckverbindern ist möglich. 50 Ω und 75 Ω -Ausführungen sind steckkompatibel.

Features

- ▶ Interface according to DIN 41626-T2 (not intermateable with 50 Ω)
- ▶ Frequency range DC to 1.5 GHz
- ▶ Return loss (cable connector straight) ≥ 20 dB (typ.)
- ▶ Impedance 50 Ω
- ▶ Plug-in/Snap-in DIN 41612 chassis

Product Range

Connectors are available on request

Technical Data Inserts Coax 0.8-2.7 DIN 41626-T2 75 Ω

Code 745

Applicable standards Anwendbare Normen	
Interface according to Interface gemäß	DIN 41626-T2 (not intermateable with 50 Ω)
Electrical data Elektrische Daten	
Impedance Wellenwiderstand	75 Ω
Frequency range Frequenzbereich	DC to 1.5 GHz
Return loss (cable connector straight) Rückflussdämpfung (Kabelsteckverbinder gerade)	≥ 20 dB (typ.)
Insertion loss Dämpfung	≤ 0.1 × √f (GHz) dB
Insulation resistance Isolationswiderstand	≥ 0.2 GΩ
Center contact resistance Übergangswiderstand Innenleiter	≤ 10 mΩ
Outer contact resistance Übergangswiderstand Außenleiter	≤ 3 mΩ
Test voltage Prüfspannung	750 V rms
Working voltage Betriebsspannung	250 V rms
RF leakage - Interface Schirmdämpfung	≥ 80 dB @ DC to 0.5 GHz ≥ 65 dB @ 0.5 GHz to 1.5 GHz
Mechanical data Mechanische Daten	
Mating cycles Steckzyklen	≥ 500
Connector captivation in plastic Haltekraft des Steckverbinders in Kunststoff	≥ 52 N
Center contact captivation Innenleiter Haltekraft	axial: ≥ 10 N
Engagement force Steckkraft	≤ 10 N
Disengagement force Ziehkraft	≤ 10 N
Environmental data Umweltdaten	
Temperature range Temperaturbereich	-55 °C to +125 °C
Dry heat Trockene Wärme	IEC 60068-2-2
Damp heat Feuchte Wärme	IEC 60068-2-78
Climatic category Klimakategorie	IEC 60068-2-1 55/125/21
Max. soldering temperature (PCB connectors) Max. Löttemperatur (Leiterplattensteckverbinder)	IEC 61760-1, +260 °C for 10 sec.
Materials Materialien	
Spring loaded contact parts Federnde Kontaktteile	CuBe, Au plating
Center contact Innenleiter	CuZn, Au plating
Outer contact Außenleiter	CuZn, Au plating
Crimping ferrule Crimphülse	Cu, Au plating
Clip Clip	CuBe, Ni plating
Dielectric Dielektrikum	PTFE

Rosenberger connectors generally fulfill the indicated technical data. Individual values of connectors may deviate depending upon application, design, type of cable, assembly method and workmanship. Data sheets for particular products can be downloaded on our website or can be provided on request from your Rosenberger sales partner.

Rosenberger-Steckverbinder erfüllen grundsätzlich die hier angegebenen technischen Daten. Je nach Anwendung, Bauart, Kabeltyp, Montageart und -ausführung können einzelne Werte der Steckverbinder hiervon abweichen. Datenblätter zu einzelnen Produkten können Sie von unserer Website herunterladen oder auf Anfrage von Ihrem Rosenberger-Ansprechpartner erhalten.

Inserts Coax D-Sub

Interface Dimensions Inserts Coax D-Sub

Code 55

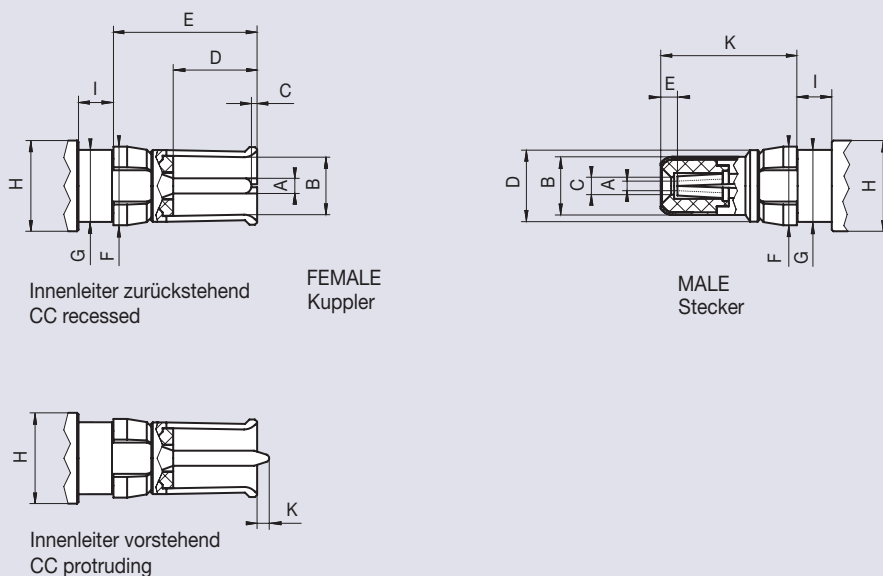

	Male Stecker		Female Kuppler	
	min.	max.	min.	max.
A	Ø 0.99	Ø 1.01		1) 2)
B	1) 2)		Ø 3.85	
C	0.10	0.50	-	Ø 1.20
D	5.45	5.65	-	Ø 4.75
E	9.35	9.50	0.90	1.10
F	-	Ø 5.25	-	Ø 5.25
G	Ø 4.76	Ø 4.79	Ø 4.76	Ø 4.79
H	-	Ø 6.00 ³⁾	-	Ø 6.00 ³⁾
I	2.22	2.40	2.22	2.40
K	0.40	0.80	8.85	9.00

Dimensions in mm

¹⁾ Contact diameter refers to 50 Ω

²⁾ Resilient, dimension to meet electrical and mechanical requirements

³⁾ Square shape optional

Features

- ▶ Interface according to D-Sub connectors
- ▶ Frequency range DC to 2 GHz
- ▶ Return loss (cable connector straight) ≥ 14 dB @ 2 GHz
- ▶ Impedance 50 Ω
- ▶ Plug-in/Snap-in D-Sub chassis
- ▶ Inverse center contact

Product Range

Connectors are available on request

Technical Data Inserts Coax D-Sub

Code 55

Applicable standards Anwendbare Normen	
Interface according to Interface gemäß	D-Sub
Electrical data Elektrische Daten	
Impedance Wellenwiderstand	50 Ω
Frequency range Frequenzbereich	DC to 2 GHz
Return loss (cable connector straight) Rückflusdämpfung (Kabelsteckverbinder gerade)	≥ 30 dB @ DC to 0.1 GHz ≥ 20 dB @ 0.1 GHz to 0.5 GHz ≥ 14 dB @ 0.5 GHz to 2 GHz
Insertion loss Dämpfung	≤ 0.1 × √f (GHz) dB
Insulation resistance Isolationswiderstand	≥ 10 GΩ
Center contact resistance Übergangswiderstand Innenleiter	≤ 10 mΩ
Outer contact resistance Übergangswiderstand Außenleiter	≤ 3 mΩ
Test voltage Prüfspannung	1500 V rms
Working voltage Betriebsspannung	500 V rms
RF leakage - Interface Schirmdämpfung	≥ 80 dB @ DC to 0.5 GHz ≥ 65 dB @ 0.5 GHz to 1.5 GHz
Mechanical data Mechanische Daten	
Mating cycles Steckzyklen	≥ 50
Connector captivation in plastic Haltekraft des Steckverbinders in Kunststoff	≥ 52 N
Center contact captivation Innenleiter Haltekraft	axial: ≥ 10 N
Engagement force Steckkraft	≤ 10 N
Disengagement force Ziehkraft	≤ 10 N
Environmental data Umweltdaten	
Temperature range Temperaturbereich	-55 °C to +125 °C
Dry heat Trockene Wärme	IEC 60068-2-2
Damp heat Feuchte Wärme	IEC 60068-2-78
Climatic category Klimakategorie	IEC 60068-2-1 55/125/21
Max. soldering temperature (PCB connectors) Max. Löttemperatur (Leiterplattensteckverbinder)	IEC 61760-1, +260 °C for 10 sec.
Materials Materialien	
Spring loaded contact parts Federnde Kontaktteile	CuBe, Au plating
Center contact Innenleiter	CuZn, Au plating
Outer contact Außenleiter	CuZn, Au plating
Crimping ferrule Crimphülse	Cu, Au plating
Clip Clip	CuBe, Ni plating
Dielectric Dielektrikum	PTFE

Rosenberger connectors generally fulfill the indicated technical data. Individual values of connectors may deviate depending upon application, design, type of cable, assembly method and workmanship. Data sheets for particular products can be downloaded on our website or can be provided on request from your Rosenberger sales partner.

Rosenberger-Steckverbinder erfüllen grundsätzlich die hier angegebenen technischen Daten. Je nach Anwendung, Bauart, Kabeltyp, Montageart und -ausführung können einzelne Werte der Steckverbinder hiervon abweichen. Datenblätter zu einzelnen Produkten können Sie von unserer Website herunterladen oder auf Anfrage von Ihrem Rosenberger-Ansprechpartner erhalten.

Inserts Power DIN 41626-T1 / D-Sub

Interface Dimensions Inserts Power DIN 41626-T1 / D-Sub

Code 50

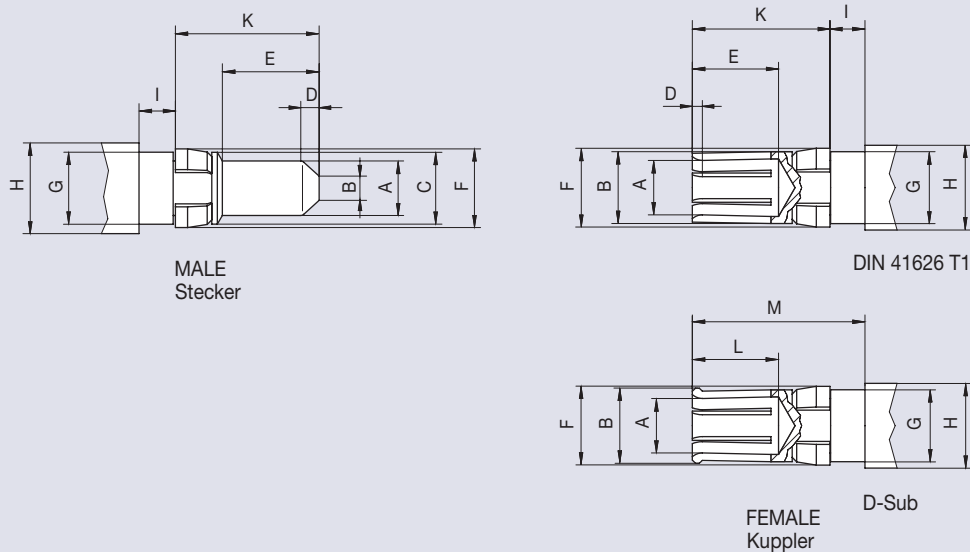

	Male Stecker		Female Kuppler	
	min.	max.	min.	max.
A	Ø 3.55	Ø 3.60		1)
B	Ø 1.00	Ø 1.60	–	Ø 4.75
C	–	Ø 4.76	–	–
D	0.90	1.10	0.40	0.50
E	6.40	6.50	5.70	5.85
F	–	Ø 5.25	–	Ø 5.25
G	Ø 4.76	Ø 4.79	Ø 4.76	Ø 4.79
H	–	Ø 6.00 2)	–	Ø 6.00 2)
I	2.22	2.40	2.22	2.40
K	9.50	9.65	9.00	9.15
L	–	–	–	6.50
M	–	–	11.75	11.90

Dimensions in mm

¹⁾ Resilient, dimension to meet electrical and mechanical requirements
²⁾ Square shape optional

High Power Inserts meet the requirements of DIN 41626-T1 and are designed for use in mixed card edge connections in accordance to DIN 41612 or D-Sub. The contacts are installed by snap-in method, a combination with coaxial connectors, high current and high voltage connectors is possible.

Hochstrom-Einsätze entsprechen der Norm DIN 41626-T1 und sind für Anwendungen in Mischleisten nach DIN 41612 oder D-Sub ausgelegt. Die Montage der Kontakte erfolgt durch Einrasten, eine Kombination mit Koaxial-Steckverbindern, Hochstrom- und Hochspannungs-Steckverbindern ist möglich.

Features

- ▶ Interface according to DIN 41626-T1 / D-Sub
- ▶ Contact current 10 A, 20 A, 30 A, 40 A
- ▶ Plug-in/Snap-in DIN 41612 chassis

Product Range

Connectors are available on request

Technical Data Inserts Power DIN 41626-T1 / D-Sub

Code 50

Applicable standards Anwendbare Normen	
Interface according to Interface gemäß	DIN 41626-T1, D-Sub
Electrical data Elektrische Daten	
Contact resistance Übergangswiderstand	≤ 1 mΩ
Contact current Kontaktstrombelastbarkeit	10 A, 20 A, 30 A, 40 A
Mechanical data Mechanische Daten	
Mating cycles Steckzyklen	≥ 500
Connector captivation in plastic Haltekraft des Steckverbinders in Kunststoff	≥ 52 N
Engagement force Steckkraft	≤ 10 N
Disengagement force Ziehkraft	≥ 1.6 N
Environmental data Umweltdaten	
Temperature range Temperaturbereich	-55 °C to +125 °C
Dry heat Trockene Wärme	IEC 60068-2-2
Damp heat Feuchte Wärme	IEC 60068-2-78
Climatic category Klimakategorie	IEC 60068-2-1 55/125/21
Max. soldering temperature (PCB connectors) Max. Löttemperatur (Leiterplattensteckverbinder)	IEC 61760-1, +260 °C for 10 sec.
Materials Materialien	
Spring loaded contact parts Federnde Kontaktteile	CuBe / CuSn, Au plating
Center contact Innenleiter	CuZn, Au plating
Clip Clip	CuBe, Ni plating

Rosenberger connectors generally fulfill the indicated technical data. Individual values of connectors may deviate depending upon application, design, type of cable, assembly method and workmanship. Data sheets for particular products can be downloaded on our website or can be provided on request from your Rosenberger sales partner.

Rosenberger-Steckverbinder erfüllen grundsätzlich die hier angegebenen technischen Daten. Je nach Anwendung, Bauart, Kabeltyp, Montageart und -ausführung können einzelne Werte der Steckverbinder hiervon abweichen. Datenblätter zu einzelnen Produkten können Sie von unserer Website herunterladen oder auf Anfrage von Ihrem Rosenberger-Ansprechpartner erhalten.

Inserts High Voltage DIN 41626-T2

Interface Dimensions Inserts High Voltage DIN 41626-T2

Code 25

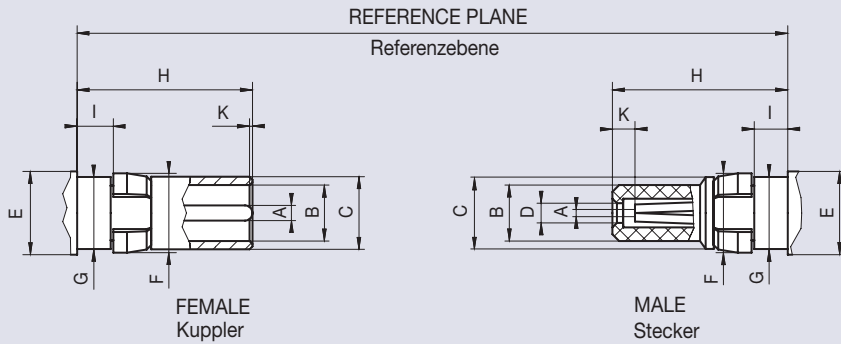

	Female Kuppler		Male Stecker	
	min.	max.	min.	max.
A	Ø 0.99	Ø 1.04		1)
B	Ø 3.69	Ø 3.75	Ø 3.55	Ø 3.65
C	Ø 4.70	Ø 4.80	Ø 4.70	Ø 4.80
D	-	-	Ø 1.25	Ø 1.35
E	-	Ø 5.50	-	Ø 5.50
F	-	Ø 5.25	-	Ø 5.25
G	Ø 4.74	Ø 4.79	Ø 4.74	Ø 4.79
H	11.50	11.70	11.50	11.70
I	2.22	2.40	2.22	2.40
K	-0.25	0.25	1.10	1.70

Dimensions in mm

¹⁾ Resilient, dimension to meet electrical and mechanical requirements

High Voltage Inserts are designed for use in mixed card edge connections in accordance to DIN 41612. Small dimensions enable high packing densities, the contacts are installed by snap-in method. A combination with coaxial connectors, high current and high voltage connectors is possible.

Please note - reverse polarity design

Male connectors are equipped with female center contacts, female connectors with male center contacts.

Hochspannungs-Einsätze sind für den Einsatz in Mischleisten nach DIN 41612 ausgelegt, die geringe Baugröße ermöglicht hohe Packungsdichten. Die Montage in Leisten erfolgt durch Einrasten, eine Kombination mit Koaxial-Steckverbindern, Hochstrom- und Hochspannungs-Steckverbindern ist möglich.

Achtung - Reverse Polarity-Ausführung:

Die Stecker sind mit einem Buchsen-Innenleiter, die Kuppler mit einem Stift-Innenleiter ausgestattet.

Features

- ▶ Interface according to DIN 41626-T2
- ▶ Working voltage 2800 V rms
- ▶ Plug-in/Snap-in DIN 41612 chassis
- ▶ Inverse center contact

Product Range

Connectors are available on request

Technical Data Inserts High Voltage DIN 41626-T2

Code 25

Applicable standards Anwendbare Normen	
Interface according to Interface gemäß	DIN 41626-T2
Electrical data Elektrische Daten	
Contact resistance Übergangswiderstand	≤ 3 mΩ
Test voltage Prüfspannung	3800 V rms
Working voltage Betriebsspannung	2800 V rms
Contact current Kontaktstrombelastbarkeit	≤ 1.5 A
Mechanical data Mechanische Daten	
Mating cycles Steckzyklen	≥ 100
Environmental data Umweltdaten	
Temperature range Temperaturbereich	-55 °C to +125 °C
Dry heat Trockene Wärme	IEC 60068-2-2
Damp heat Feuchte Wärme	IEC 60068-2-78
Climatic category Klimakategorie	IEC 60068-2-1 55/125/21
Materials Materialien	
Spring loaded contact parts Federnde Kontaktteile	CuBe, Au plating
Center contact Innenleiter	CuZn, Au plating
Clip Clip	CuBe, Ni plating
Dielectric Dielektrikum	PTFE

Rosenberger connectors generally fulfill the indicated technical data. Individual values of connectors may deviate depending upon application, design, type of cable, assembly method and workmanship. Data sheets for particular products can be downloaded on our website or can be provided on request from your Rosenberger sales partner.

Rosenberger-Steckverbinder erfüllen grundsätzlich die hier angegebenen technischen Daten. Je nach Anwendung, Bauart, Kabeltyp, Montageart und -ausführung können einzelne Werte der Steckverbinder hiervon abweichen. Datenblätter zu einzelnen Produkten können Sie von unserer Website herunterladen oder auf Anfrage von Ihrem Rosenberger-Ansprechpartner erhalten.

Inserts Mini-Coax

Interface Dimensions Inserts Mini-Coax

Code 23

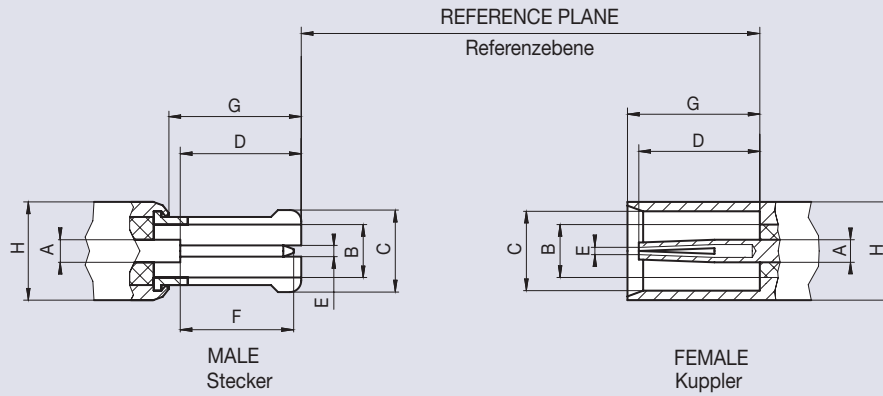

	Male Stecker		Female Kuppler	
	min.	max.	min.	max.
A	Ø 0.60 nom.		Ø 0.60 nom.	
B	Ø 1.40 nom.		Ø 1.40 nom.	
C	1)		Ø 2.10	Ø 2.125
D	3.20	–	–	3.20
E	0.30	0.33	1)	
F	3.00 nom.		–	–
G	–	3.50	3.50	–
H	Ø 2.60 nom.		Ø 2.60 nom.	

Dimensions in mm

¹⁾ Resilient, dimension to meet electrical and mechanical requirements

Features

- ▶ Interface according to Rosenberger Mini-Coax
- ▶ Frequency range DC to 6 GHz
- ▶ Return loss (cable connector straight) ≥ 28 dB @ 6 GHz
- ▶ Impedance 50 Ω
- ▶ Plug-in/Snap-in Metral chassis

Product Range

Connectors are available on request

Technical Data Inserts Mini-Coax

Code 23

Applicable standards Anwendbare Normen	
Interface according to Interface gemäß	Rosenberger Mini-Coax
Electrical data Elektrische Daten	
Impedance Wellenwiderstand	50 Ω
Frequency range Frequenzbereich	DC to 6 GHz
Return loss (cable connector straight) Rückflusdämpfung (Kabelsteckverbinder gerade)	≥ 28 dB @ DC to 1 GHz ≥ 24 dB @ 1 GHz to 3 GHz ≥ 16 dB @ 3 GHz to 6 GHz
Insertion loss Dämpfung	≤ 0.1 × √f (GHz) dB
Insulation resistance Isolationswiderstand	≥ 1 GΩ
Center contact resistance Übergangswiderstand Innenleiter	≤ 10 mΩ
Outer contact resistance Übergangswiderstand Außenleiter	≤ 3 mΩ
Test voltage Prüfspannung	750 V rms
Working voltage Betriebsspannung	500 V rms
RF leakage - Interface Schirmdämpfung	≥ 80 dB @ DC to 1 GHz ≥ 60 dB @ 1 GHz to 4 GHz
Mechanical data Mechanische Daten	
Mating cycles Steckzyklen	≥ 500
Engagement force Steckkraft	1 N to 4 N
Disengagement force Ziehkraft	1 N to 4 N
Environmental data Umweltdaten	
Temperature range Temperaturbereich	-40 °C to +85 °C
Dry heat Trockene Wärme	IEC 60068-2-2
Damp heat Feuchte Wärme	IEC 60068-2-78
Climatic category Klimakategorie	IEC 60068-2-1 40/85/21
Shock Schock	IEC 60068-2-27 (50g halfsinus 2 shocks/axis during 11 sec.)
Max. soldering temperature (PCB connectors) Max. Löttemperatur (Leiterplattensteckverbinder)	IEC 61760-1, +260 °C for 10 sec.
Materials Materialien	
Spring loaded contact parts Federnde Kontaktteile	CuBe, Au plating
Center contact Innenleiter	CuBe, Au plating
Outer contact Außenleiter	CuZn, Au plating
Crimping ferrule Crimphülse	Cu, Au plating
Dielectric Dielektrikum	PTFE

Rosenberger connectors generally fulfill the indicated technical data. Individual values of connectors may deviate depending upon application, design, type of cable, assembly method and workmanship. Data sheets for particular products can be downloaded on our website or can be provided on request from your Rosenberger sales partner.

Rosenberger-Steckverbinder erfüllen grundsätzlich die hier angegebenen technischen Daten. Je nach Anwendung, Bauart, Kabeltyp, Montageart und -ausführung können einzelne Werte der Steckverbinder hiervon abweichen. Datenblätter zu einzelnen Produkten können Sie von unserer Website herunterladen oder auf Anfrage von Ihrem Rosenberger-Ansprechpartner erhalten.

BNC TNC



BNC coaxial connectors, with a two stud bayonet coupling mechanism for easy, fast and reliable connections, are mainly applied in data systems and telecom applications.

TNC coaxial connectors are based on BNC connector characteristics and interface dimensions. The screw-on coupling mechanism enables quicker and easier interconnections compared to BNC connectors.

BNC-Koaxial-Steckverbinder verfügen über einen 2-nockigen Bajonettverschluss für einfache, schnelle und zuverlässige Steckverbindungen. Anwendungsbereiche sind insbesondere Datentechnik und Telekommunikation.

TNC-Koaxial-Steckverbinder basieren in Eigenschaften und Abmessungen auf der Serie BNC, sind jedoch Schraubsteckverbinder und damit schneller und einfacher zu montieren als BNC-Steckverbinder.

BNC 50 Ω

BNC 75 Ω

TNC 50 Ω

TNC 75 Ω



BNC 50 Ω

Interface Dimensions BNC 50 Ω

Code 51

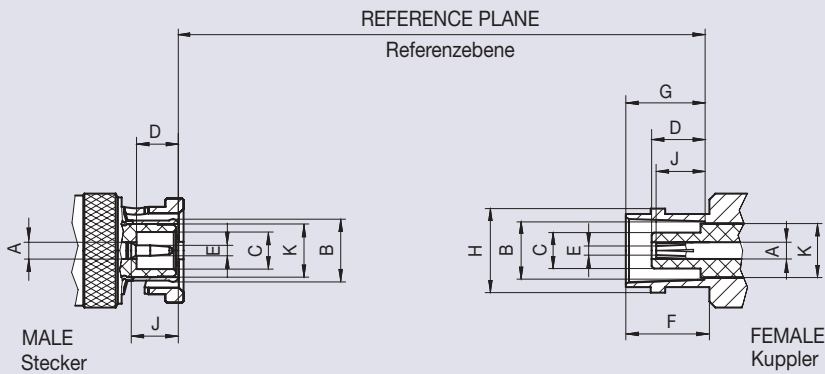

	Male Stecker		Female Kuppler	
	min.	max.	min.	max.
A	Ø 2.14 nom.		Ø 2.14 nom.	
B	1)		Ø 8.10	Ø 8.15
C	Ø 4.83	–	–	Ø 4.72
D	5.28	–	–	5.28
E	Ø 1.32	Ø 1.37	1)	
F	–	–	10.52	–
G	–	–	8.31	8.51
H	–	–	10.97	11.07
I	5.33	–	4.55	5.23
K	Ø 7.00 nom.		Ø 7.00 nom.	

Dimensions in mm

¹⁾ Resilient, dimension to meet electrical and mechanical requirements

50 Ω and 75 Ω connector types are intermateable without any restrictions within BNC.

50 Ω und 75 Ω BNC Steckverbinder sind innerhalb der Serie steckkompatibel.

Features

- ▶ Interface according to IEC 61169-8, MIL-PRF-39012, CECC 22120
- ▶ Frequency range DC to 10 GHz (max.), DC to 4 GHz (opt.)
- ▶ Return loss (cable connector straight) ≥ 20 dB (typ.)
- ▶ Impedance 50 Ω
- ▶ Bayonet coupling

Product Range

- ▶ Cable connectors
- ▶ PCB connectors
- ▶ Panel connectors
- ▶ Adaptors
- ▶ Terminations
- ▶ Accessoriess

Technical Data BNC 50 Ω

Code 51

Applicable standards Anwendbare Normen	
Interface according to Interface gemäß	IEC 60169-8, MIL-PRF-39012, CECC 22120
Electrical data Elektrische Daten	
Impedance Wellenwiderstand	50 Ω
Frequency range Frequenzbereich	DC to 10 GHz (max.) DC to 4 GHz (opt.)
Return loss (cable connector straight) Rückflussdämpfung (Kabelsteckverbinder gerade)	≥ 20 dB (typ.)
Insertion loss Dämpfung	≤ 0.1 × √f (GHz) dB
Insulation resistance Isolationswiderstand	≥ 5 GΩ
Center contact resistance Übergangswiderstand Innenleiter	≤ 1.5 mΩ
Outer contact resistance Übergangswiderstand Außenleiter	≤ 1 mΩ
Test voltage Prüfspannung	1500 V rms
Working voltage Betriebsspannung	400 V rms
Power handling Leistungsbelastbarkeit	80 W @ 2 GHz
Mechanical data Mechanische Daten	
Mating cycles Steckzyklen	≥ 500
Center contact captivation Innenleiter Haltekraft	axial: ≥ 27 N
Environmental data Umweltdaten	
Temperature range Temperaturbereich	-65 °C to +165 °C
Thermal shock Temperaturzyklen	MIL-STD-202, Method 107, Condition B
Corrosion resistance Korrosionsbeständigkeit	MIL-STD-202, Method 101, Condition B
Moisture resistance Feuchtigkeitsbeständigkeit	MIL-STD-202, Method 106
Vibration Vibration	MIL-STD-202, Method 204, Condition B
Shock Schock	MIL-STD-202, Method 213, Condition G
Max. soldering temperature (PCB connectors) Max. Löttemperatur (Leiterplattensteckverbinder)	IEC 61760-1, +260 °C for 10 sec.
Materials Materialien	
Spring loaded contact parts Federnde Kontaktteile	CuBe / CuSn, Au plating
Center contact Innenleiter	CuZn, Au plating
Outer contact Außenleiter	CuZn, Ni / Ag / white bronze plating
Crimping ferrule Crimphülse	Cu, white bronze plating
Dielectric Dielektrikum	PTFE
Gasket Dichtung	Rubber

Rosenberger connectors generally fulfill the indicated technical data. Individual values of connectors may deviate depending upon application, design, type of cable, assembly method and workmanship. Data sheets for particular products can be downloaded on our website or can be provided on request from your Rosenberger sales partner.

Rosenberger-Steckverbinder erfüllen grundsätzlich die hier angegebenen technischen Daten. Je nach Anwendung, Bauart, Kabeltyp, Montageart und -ausführung können einzelne Werte der Steckverbinder hiervon abweichen. Datenblätter zu einzelnen Produkten können Sie von unserer Website herunterladen oder auf Anfrage von Ihrem Rosenberger-Ansprechpartner erhalten.

Cable Connectors - Semi-Rigid Cables

Straight Plug, solder

Semi-Rigid Cables

Rosenberger No.	Order No.	Sales Unit	Packaging	Cable Group	
51 S 101-272 B5	103745	50	standard	72	

Panel Jack, solder, hexagonal flange



Semi-Rigid Cables

Rosenberger No.	Order No.	Sales Unit	Packaging	Remarks	Cable Group	
51 K 611-271 N5	105373	50	standard	hexagonal flange rear mount	71	
51 K 611-272 N5	108004	50	standard	hexagonal flange rear mount	72	

Cable Connectors - Flexible Cables

Straight Plug, clamp



Flexible Cables

Rosenberger No.	Order No.	Sales Unit	Packaging	Remarks	Cable Group	
51 S 106-001 N5	101125	25	standard	captivated center contact	01	
51 S 106-002 N5	100814	25	standard	captivated center contact	02, 03	
51 S 106-006 N5	101996	50	standard	captivated center contact	06, 07, 08	
51 S 105-015 N5	139738	50	standard		15, 17	

Straight Plug, crimp

Flexible Cables

Rosenberger No.	Order No.	Sales Unit	Packaging	Cable Group	
51 S 107-801 N5	102687	50	standard	01	
51 S 107-802 N5	101759	50	standard	02	
	196393	100	standard	02	
51 S 107-803 N5	106798	50	standard	03	

Rosenberger No.	Order No.	Sales Unit	Packaging	Cable Group	
51 S 107-106 N5	192064	50	standard	06	
	217671	100	standard	06	
51 S 107-108 N5	101731	50	standard	07, 08	
	151726	100	standard	07, 08	
51 S 101-115 N5	104715	50	standard	15	
51 S 101-117 N5	100919	50	standard	17	



Right Angle Plug, clamp

Flexible Cables

Rosenberger No.	Order No.	Sales Unit	Packaging	Cable Group	
51 S 201-006 N5	105704	25	standard	06, 07, 08	

Right Angle Plug, solder crimp

Flexible Cables

Rosenberger No.	Order No.	Sales Unit	Packaging	Cable Group	
51 S 207-302 N5	135947	50	box	02	
51 S 207-303 N5	140216	100	box	03	
51 S 207-306 N5	145831	50	box	06	
51 S 207-308 N5	145815	100	box	07, 08	



Straight Jack, clamp

Flexible Cables

Rosenberger No.	Order No.	Sales Unit	Packaging	Cable Group	
51 K 106-002 N5	145823	25	standard	02	
51 K 106-006 N5	103835	25	standard	06	

Straight Jack, crimp

Flexible Cables

Rosenberger No.	Order No.	Sales Unit	Packaging	Cable Group	
51 K 107-801 N5	137307	25	standard	01	
51 K 107-802 N5	136841	25	standard	02	
51 K 107-803 N5	139390	25	standard	03	
51 K 107-106 N5	135262	25	standard	06	
51 K 107-108 N5	135344	25	standard	07, 08	



Panel Jack, crimp, round flange

Flexible Cables

Rosenberger No.	Order No.	Sales Unit	Packaging	Remarks	Cable Group	
51 K 507-801 N5	134958	50	standard	round flange front mount	01	
51 K 507-802 N5	135765	50	standard	round flange front mount	02	
51 K 507-803 N5	137901	50	standard	round flange front mount	03	

Panel Jack, crimp, hexagonal flange

Flexible Cables

Rosenberger No.	Order No.	Sales Unit	Packaging	Remarks	Cable Group	
51 K 607-801 N5	107687	50	standard	hexagonal flange rear mount	01	
51 K 607-802 N5	102969	50	standard	hexagonal flange rear mount	02	
51 K 607-803 N5	104004	50	standard	hexagonal flange rear mount	03	
51 K 607-106 N5	136847	50	standard	hexagonal flange rear mount	06	
51 K 607-108 N5	138698	50	standard	hexagonal flange rear mount	07, 08	

Panel Connectors - Coaxial End

Panel Jack, 4-hole flange

Coaxial End

Rosenberger No.	Order No.	Sales Unit	Packaging	Remarks	
51 K 405-500 N5	145949	25	standard	4-hole flange 17.5 mm 4 x Ø 3.2 mm	

Panel Connectors - Solder End

Panel Jack, round flange

Solder End

Rosenberger No.	Order No.	Sales Unit	Packaging	Remarks	
51 K 502-200 N5	144493	100	standard	round flange front mount length 26.2 mm	
51 K 504-200 N5	105763	100	standard	round flange front mount length 26.2 mm	
51 K 506-200 N5	108080	100	standard	round flange front mount length 30.4 mm	
51 K 507-200 N5	144715	25	standard	round flange front mount length 28.5 mm pressurized	

Panel Jack, insulated, round flange

Solder End

Rosenberger No.	Order No.	Sales Unit	Packaging	Remarks	
51 K 553-200 N5	139824	50	standard	round flange front mount	

Panel Jack, 4-hole flange

Solder End

Rosenberger No.	Order No.	Sales Unit	Packaging	Remarks	
51 K 404-200 N5	145940	25	standard	4-hole flange 17.5 mm 4 x Ø 3.1 mm	

Right Angle Panel Jack, 4-hole flange

Solder End

Rosenberger No.	Order No.	Sales Unit	Packaging	Remarks	
51 K 201-200 N5	185603	50	standard	4-hole flange 17.5 mm 4 x Ø 3.1 mm	

PCB Connectors - Solder Pin



Straight Jack, PCB

Solder Pin

Rosenberger No.	Order No.	Sales Unit	Packaging	Remarks	
51 K 101-400 A5	101796	50	blister	round pins	

Right Angle Jack, PCB

Solder Pin





Rosenberger No.	Order No.	Sales Unit	Packaging	Remarks	
51 K 201-400 A5	102609	50	blister	round pins	
51 K 204-400 A5	103623	25	blister	round pins Ø 12.5 mm insulation sleeve	

Adaptors

Adaptors BNC 50 Ω - BNC 50 Ω

Rosenberger No.	Order No.	Sales Unit	Packaging	Remarks	Return Loss	
51 S 101-S00 N5	142480	1	standard	BNC male - male		
51 S 121-S20 S3	108554	1	standard	BNC male - male calibration adaptor	≥ 34 dB @ DC to 2 GHz ≥ 30 dB @ 2 GHz to 4 GHz	
51 K 101-K00 N5	102160	1	standard	BNC female - female		
51 K 121-K20 S3	101391	1	standard	BNC female - female calibration adaptor	≥ 34 dB @ DC to 2 GHz ≥ 30 dB @ 2 GHz to 4 GHz	
51 K 401-K00 N5	147930	1	standard	BNC female - female 4-hole flange 17.5 mm 4 x M2.5		
51 K 501-K00 N5	105676	1	standard	BNC female - female round flange pressurized		
51 K 542-K00 A5	144823	1	standard	BNC female - female round flange insulated		



BNC 50 Ω

Rosenberger No.	Order No.	Sales Unit	Packaging	Remarks	Return Loss	
51 S 201-K00 N5	100754	1	box	BNC male - female right angle		
51 S 301-K00 N5	101014	25	standard	BNC female - male - female T-adaptor		
51 S 303-K00 N5	145948	1	standard	BNC male - female - female T-adaptor		
51 K 301-K00 N5	144498	1	standard	BNC female - female - female T-adaptor		

Adaptors BNC 50 Ω - TNC 50 Ω

Rosenberger No.	Order No.	Sales Unit	Packaging	Remarks	
51 S 156-S00 N5	139836	1	standard	BNC male - TNC male	
51 S 156-K00 N5	102737	1	standard	BNC male - TNC female	
51 K 156-K00 N5	139851	1	standard	BNC female - TNC female	
56 S 151-K00 N5	139867	1	standard	TNC male - BNC female	





Adaptors BNC 50 Ω - UHF

Rosenberger No.	Order No.	Sales Unit	Packaging	Remarks	
51 S 154-K00 N5	157308	1	standard	BNC male - UHF female	
54 S 151-K00 A1	105681	1	standard	UHF male - BNC female	

Adaptors BNC 50 Ω - Microdot

Rosenberger No.	Order No.	Sales Unit	Packaging	Remarks	
51 S 131-K00 N5	104029	1	standard	BNC male - Microdot female	

Adaptors BNC 50 Ω - SMB

Rosenberger No.	Order No.	Sales Unit	Packaging	Remarks	
59 S 151-S00 L5	196195	1	standard	SMB male - BNC male	
59 S 151-K00 L5	196194	1	standard	SMB male - BNC female	
59 K 151-S00 L5	104641	1	standard	SMB female - BNC male	
59 K 151-K00 L5	196192	1	standard	SMB female - BNC female	

Adaptors BNC 50 Ω - SMA

Rosenberger No.	Order No.	Sales Unit	Packaging	Remarks	
32 S 151-S00 L5	103531	1	standard	SMA male - BNC male	
32 S 151-K00 L5	106545	1	standard	SMA male - BNC female	
32 K 151-S00 L5	103503	1	standard	SMA female - BNC male	
32 K 151-K00 L5	102638	1	standard	SMA female - BNC female	

BNC 50 Ω

Adaptors BNC 50 Ω - N 50 Ω

Rosenberger No.	Order No.	Sales Unit	Packaging	Remarks	
51 S 153-S00 N5	104872	1	standard	BNC male - N male	
51 S 153-K00 N5	139877	1	standard	BNC male - N female	
53 S 151-K00 N5	107599	1	standard	N male - BNC female	
53 K 151-K00 N5	139881	1	standard	N female - BNC female	

Adaptors BNC 50 Ω - RPC-N 50 Ω

Rosenberger No.	Order No.	Sales Unit	Packaging	Remarks	Return Loss	
05 S 151-S20 S3	101155	1	standard	RPC-N 50 Ω male - BNC 50 Ω male, calibration adaptor	≥ 36 dB @ DC to 2 GHz ≥ 30 dB @ 2 GHz to 4 GHz	
05 K 151-K20 S3	105131	1	standard	RPC-N 50 Ω female - BNC 50 Ω female, calibration adaptor	≥ 36 dB @ DC to 2 GHz ≥ 30 dB @ 2 GHz to 4 GHz	

Adaptors BNC 50 Ω - RPC-7

Rosenberger No.	Order No.	Sales Unit	Packaging	Remarks	Return Loss	
07 P 151-K00 S3	101980	1	standard	RPC-7 - BNC 50 Ω female	≥ 22 dB @ DC to 4 GHz	
07 P 151-S00 S3	107170	1	standard	RPC-7 - BNC 50 Ω male	≥ 22 dB @ DC to 4 GHz	

Terminations

Termination Plug



Rosenberger No.	Order No.	Sales Unit	Packaging	Remarks	Return Loss	
51 S 1RR-001 N4	142483	10	blister	1 Watt Frequency: DC to 2 GHz	≥ 20.8 dB @ DC to 1 GHz ≥ 15.6 dB @ 1 GHz to 2 GHz	
51 S 170-C10 S3	108569	1	standard	1 Watt Frequency: DC to 4 GHz for calibration kit	≥ 34 dB @ DC to 2 GHz ≥ 30 dB @ 2 GHz to 4 GHz	

Termination Jack

Rosenberger No.	Order No.	Sales Unit	Packaging	Remarks	Return Loss	
51 K 170-C10 S3	102690	1	standard	1 Watt Frequency: DC to 4 GHz for calibration kit	≥ 34 dB @ DC to 2 GHz ≥ 30 dB @ 2 GHz to 4 GHz	

Accessories

Protection Cap

Rosenberger No.	Order No.	Sales Unit	Packaging	Remarks	
51 Z 110-000 N	143457	25	standard	male	
51 Z 112-000 N	151143	100	standard	male with chain	
51 Z 115-000 N	105548	25	standard	female with chain	

Shorting Cap

Rosenberger No.	Order No.	Sales Unit	Packaging	Remarks	
51 Z 111-000 N5	145953	50	standard	male with chain	

Lötfahne

Rosenberger No.	Order No.	Sales Unit	Packaging	Remarks	
51 Z 120-000 B	103870	500	standard	for panel jacks outer Ø 15 mm inner Ø 9.7 mm	

Spring Washer

Rosenberger No.	Order No.	Sales Unit	Packaging	Remarks	
51 Z 121-000 N	105852	100	standard	for panel jacks outer Ø 14.5 mm inner Ø 10 mm	

Insulation Washer

Rosenberger No.	Order No.	Sales Unit	Packaging	Remarks	
51 Z 122-000	100908	100	standard	for panel jacks outer Ø 14 mm inner Ø 9.9 mm	
51 Z 322-000	100468	100	standard	for panel jacks outer Ø 20 mm inner Ø 12.85 mm	

Interface Dimensions BNC 75 Ω

Code 71

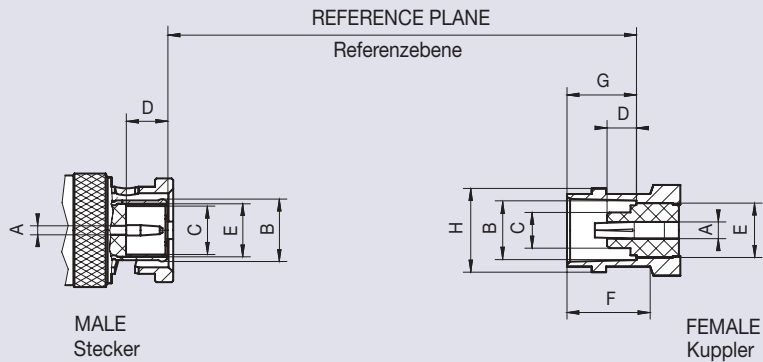

	Male Stecker		Female Kuppler	
	min.	max.	min.	max.
A	Ø 1.32	Ø 1.37	Ø 1.88	Ø 2.29
B	1)		Ø 8.10	Ø 8.15
C	Ø 4.83	–	–	Ø 4.72
D	5.28	5.79	–	2.31
E	Ø 7.00 nom.		Ø 7.00 nom.	
F	–	–	10.52	–
G	–	–	8.31	8.51
H	–	–	10.97	11.07

Dimensions in mm

¹⁾ Resilient, dimension to meet electrical and mechanical requirements

50 Ω and 75 Ω connector types are intermateable without any restrictions within BNC.

50 Ω und 75 Ω BNC Steckverbinder sind innerhalb der Serie steckkompatibel.

Features

- ▶ Interface according to IEC 61169-8, MIL-PRF-39012, CECC 22120
- ▶ Frequency range DC to 4 GHz (max.), DC to 1 GHz (opt.)
- ▶ Return loss (cable connector straight) ≥ 20 dB (typ.)
- ▶ Impedance 75 Ω
- ▶ Bayonet coupling

Product Range

- ▶ Cable connectors
- ▶ PCB connectors
- ▶ Panel connectors
- ▶ Adaptors
- ▶ Terminations

Technical Data BNC 75 Ω

Code 71

Applicable standards Anwendbare Normen	
Interface according to Interface gemäß	IEC 61169-8, MIL-PRF-39012, CECC 22120
Electrical data Elektrische Daten	
Impedance Wellenwiderstand	75 Ω
Frequency range Frequenzbereich	DC to 4 GHz (max.) DC to 1 GHz (opt.)
Return loss (cable connector straight) Rückflusdämpfung (Kabelsteckverbinder gerade)	≥ 20 dB (typ.)
Insertion loss Dämpfung	≤ 0.1 × √f (GHz) dB
Insulation resistance Isolationswiderstand	≥ 5 GΩ
Center contact resistance Übergangswiderstand Innenleiter	≤ 1.5 mΩ
Outer contact resistance Übergangswiderstand Außenleiter	≤ 1 mΩ
Test voltage Prüfspannung	1500 V rms
Working voltage Betriebsspannung	400 V rms
Power handling Leistungsbelastbarkeit	80 W @ 2 GHz
Mechanical data Mechanische Daten	
Mating cycles Steckzyklen	≥ 500
Center contact captivation Innenleiter Haltekraft	axial: ≥ 27 N
Environmental data Umweltdaten	
Temperature range Temperaturbereich	-65 °C to +165 °C
Thermal shock Temperaturzyklen	MIL-STD-202, Method 107, Condition B
Corrosion resistance Korrosionsbeständigkeit	MIL-STD-202, Method 101, Condition B
Moisture resistance Feuchtigkeitsbeständigkeit	MIL-STD-202, Method 106
Vibration Vibration	MIL-STD-202, Method 204, Condition B
Shock Schock	MIL-STD-202, Method 213, Condition G
Max. soldering temperature (PCB connectors) Max. Löttemperatur (Leiterplattensteckverbinder)	IEC 61760-1, +260 °C for 10 sec.
Materials Materialien	
Spring loaded contact parts Federnde Kontaktteile	CuBe / CuSn, Au plating
Center contact Innenleiter	CuZn, Au plating
Outer contact Außenleiter	CuZn, Ni / white bronze plating
Crimping ferrule Crimphülse	Cu, white bronze plating
Dielectric Dielektrikum	PTFE
Gasket Dichtung	Rubber

Rosenberger connectors generally fulfill the indicated technical data. Individual values of connectors may deviate depending upon application, design, type of cable, assembly method and workmanship. Data sheets for particular products can be downloaded on our website or can be provided on request from your Rosenberger sales partner.

Rosenberger-Steckverbinder erfüllen grundsätzlich die hier angegebenen technischen Daten. Je nach Anwendung, Bauart, Kabeltyp, Montageart und -ausführung können einzelne Werte der Steckverbinder hiervon abweichen. Datenblätter zu einzelnen Produkten können Sie von unserer Website herunterladen oder auf Anfrage von Ihrem Rosenberger-Ansprechpartner erhalten.

Cable Connectors - Flexible Cables



Straight Plug, crimp

Flexible Cables

Rosenberger No.	Order No.	Sales Unit	Packaging	Remarks	Cable Group	
71 S 106-009 N5	150798	25	standard	captivated center contact	09	

Straight Plug, crimp

Flexible Cables

Rosenberger No.	Order No.	Sales Unit	Packaging	Remarks	Cable Group	
71 S 107-802 N5	248535	25	standard	length 26 mm	02	
71 S 102-140 N5	139828	25	standard	length 26.6 mm	40	
	139826	100	standard		40	
71 S 102-1V6 N5	101149	50	standard	length 26.6 mm	V6	
71 S 102-109 N5	103506	25	standard	length 29.6 mm	09	
	103022	100	standard		09	
71 S 102-110 N5	147719	100	standard	length 29.6 mm	09, 10	
71 S 102-1T6 N5	151418	50	standard	length 29.7 mm	T6	

Right Angle Plug, solder-crimp

Flexible Cables

Rosenberger No.	Order No.	Sales Unit	Packaging	Cable Group	
71 S 207-302 N5	143392	50	box	02	
71 S 201-309 N5	145954	25	box	09	

Straight Jack, crimp

Flexible Cables

Rosenberger No.	Order No.	Sales Unit	Packaging	Cable Group	
71 K 101-109 N5	102051	50	standard	09	

Panel Jack, crimp, round flange

Flexible Cables

Rosenberger No.	Order No.	Sales Unit	Packaging	Remarks	Cable Group	
71 K 507-802 N5	136594	50	standard	round flange front mount length 32.5 mm	02	
	149481	100	standard		02	

Panel Jack, crimp, hexagonal flange

Flexible Cables

Rosenberger No.	Order No.	Sales Unit	Packaging	Remarks	Cable Group	
71 K 607-802 N5	139008	25	standard	hexagonal flange rear mount length 32.5 mm	02	
71 K 611-109 N5	102277	25	standard	hexagonal flange rear mount length 34.5 mm	09	

Panel Connectors - Solder End

Panel Jack, round flange



Solder End

Rosenberger No.	Order No.	Sales Unit	Packaging	Remarks	
71 K 504-200 N5	139829	50	standard	round flange front mount length 26.3 mm	

PCB Connectors - Solder Pin

Straight Jack, PCB

Solder Pin

Rosenberger No.	Order No.	Sales Unit	Packaging	Remarks	
71 K 101-400 A5	100877	50	blister	round pins length 15.0 mm	
71 K 103-400 A5	100577	50	blister	round pins, stand-off version length 22.0 mm	

Right Angle Jack, PCB

Solder Pin

Rosenberger No.	Order No.	Sales Unit	Packaging	Remarks	
71 K 201-400 A5	101193	50	blister	round pins	

Adaptors

Adaptors BNC 75 Ω - BNC 75 Ω

Rosenberger No.	Order No.	Sales Unit	Packaging	Remarks	
71 K 101-K00 N5	105992	1	standard	BNC 75 Ω female - female	
71 K 501-K00 N5	105931	1	standard	BNC 75 Ω female - female round flange	
71 K 542-K00 A5	142983	1	standard	BNC 75 Ω female - female round flange insulated	
71 S 201-K00 N5	108018	1	standard	BNC 75 Ω male - female right angle	
71 S 301-K00 N5	103852	1	standard	BNC 75 Ω female - male - female T-adaptor	

Adaptors BNC 75 Ω - 1.6-5.6

Rosenberger No.	Order No.	Sales Unit	Packaging	Remarks	
88 S 171-S00 L5	100625	1	standard	1.6-5.6 male III. generation type A-BNC 75 Ω male	
88 S 171-K00 L5	182694	1	standard	1.6-5.6 male III. generation type A-BNC 75 Ω female	
88 K 171-K00 L5	103048	1	standard	1.6-5.6 female III. generation - BNC 75 Ω female round flange	
71 S 188-K00 L5	107786	1	standard	BNC 75 Ω male - 1.6-5.6 female III. generation	

BNC
75Ω

Terminations

Termination Plug

Rosenberger No.	Order No.	Sales Unit	Packaging	Remarks	Return Loss	
71 S 1RR-001 N4	105772	10	blister	1 Watt Frequency: DC to 2 GHz	≥ 20.8 dB @ DC to 1 GHz ≥ 15.6 dB @ 1 GHz to 2 GHz	

Interface Dimensions TNC 50 Ω

Code 56

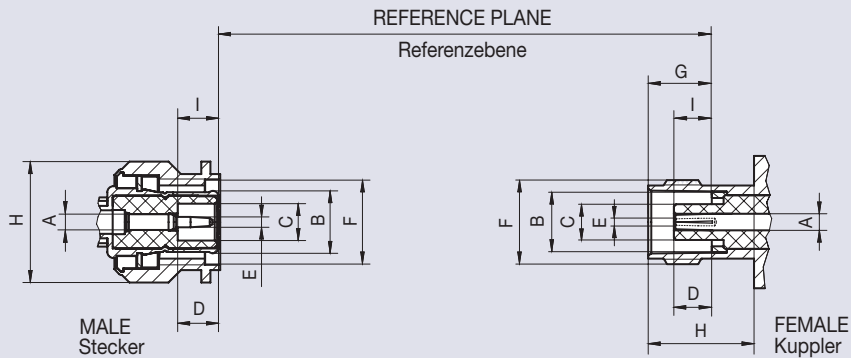

	Male Stecker		Female Kuppler	
	min.	max.	min.	max.
A	Ø 2.14 nom.		Ø 2.14 nom.	
B	1)		Ø 8.10	Ø 8.15
C	Ø 4.83	–	–	Ø 4.72
D	5.28	–	–	5.28
E	Ø 1.32	Ø 1.37	1)	
F	7/16-28 UNEF-2B		7/16-28 UNEF-2A	
G	–	–	8.31	8.51
H	–	–	10.52	–
I	5.33	–	4.55	5.23

Dimensions in mm

¹⁾ Resilient, dimension to meet electrical and mechanical requirements

50 Ω and 75 Ω connector types are intermateable without any restrictions within TNC.

50 Ω und 75 Ω TNC Steckverbinder sind innerhalb der Serie steckkompatibel.

Features

- ▶ Interface according to IEC 60169-17, MIL-PRF-39012, DIN EN 122200
- ▶ Frequency range DC to 10 GHz (max.), DC to 4 GHz (opt.)
- ▶ Return loss (cable connector straight) ≥ 20 dB (typ.)
- ▶ Impedance 50 Ω
- ▶ Screw-on coupling

Product Range

- ▶ Cable connectors
- ▶ PCB connectors
- ▶ Panel connectors
- ▶ Adaptors
- ▶ Terminations
- ▶ Accessories

Technical Data TNC 50 Ω

Code 56

Applicable standards Anwendbare Normen	
Interface according to Interface gemäß	IEC 60169-17, MIL-PRF-39012, DIN EN 122200
Electrical data Elektrische Daten	
Impedance Wellenwiderstand	50 Ω
Frequency range Frequenzbereich	DC to 10 GHz (max.) DC to 4 GHz (opt.)
Return loss (cable connector straight) Rückflussdämpfung (Kabelsteckverbinder gerade)	≥ 20 dB (typ.)
Insertion loss Dämpfung	≤ 0.1 × √f (GHz) dB
Insulation resistance Isolationswiderstand	≥ 5 GΩ
Center contact resistance Übergangswiderstand Innenleiter	≤ 1.5 mΩ
Outer contact resistance Übergangswiderstand Außenleiter	≤ 1 mΩ
Test voltage Prüfspannung	1500 V rms
Working voltage Betriebsspannung	500 V rms
Power handling Leistungsbelastbarkeit	80 W @ 2 GHz
Mechanical data Mechanische Daten	
Mating cycles Steckzyklen	≥ 500
Center contact captivation Innenleiter Haltekraft	axial: ≥ 27 N
Coupling test torque Prüfdrehmoment	≤ 1.7 Nm
Coupling torque recommended Drehmoment empfohlen	0.46 Nm to 0.69 Nm
Environmental data Umweltdaten	
Temperature range Temperaturbereich	-65 °C to +165 °C
Thermal shock Temperaturzyklen	MIL-STD-202, Method 107, Condition B
Climatic category Klimakategorie	IEC 60068-2-1 65/165/21
Corrosion resistance Korrosionsbeständigkeit	MIL-STD-202, Method 101, Condition B
Moisture resistance Feuchtigkeitsbeständigkeit	MIL-STD-202, Method 106
Vibration Vibration	MIL-STD-202, Method 204, Condition B
Shock Schock	MIL-STD-202, Method 213, Condition G
Max. soldering temperature (PCB connectors) Max. Löttemperatur (Leiterplattensteckverbinder)	IEC 61760-1, +260 °C for 10 sec.
Materials Materialien	
Spring loaded contact parts Federnde Kontaktteile	CuBe / CuSn, Au plating
Center contact Innenleiter	CuZn, Au plating
Outer contact Außenleiter	CuZn, Ni / white bronze plating
Crimping ferrule Crimphülse	Cu, white bronze plating
Dielectric Dielektrikum	PTFE
Gasket Dichtung	Rubber

Rosenberger connectors generally fulfill the indicated technical data. Individual values of connectors may deviate depending upon application, design, type of cable, assembly method and workmanship. Data sheets for particular products can be downloaded on our website or can be provided on request from your Rosenberger sales partner.

Rosenberger-Steckverbinder erfüllen grundsätzlich die hier angegebenen technischen Daten. Je nach Anwendung, Bauart, Kabeltyp, Montageart und -ausführung können einzelne Werte der Steckverbinder hiervon abweichen. Datenblätter zu einzelnen Produkten können Sie von unserer Website herunterladen oder auf Anfrage von Ihrem Rosenberger-Ansprechpartner erhalten.

Cable Connectors - Semi-Rigid Cables

Straight Plug, solder

Semi-Rigid Cables

Rosenberger No.	Order No.	Sales Unit	Packaging	Cable Group	
56 S 101-272 B5	107534	25	standard	72	

Panel Jack, solder, hexagonal flange



Semi-Rigid Cables

Rosenberger No.	Order No.	Sales Unit	Packaging	Remarks	Cable Group	
56 K 611-271 N5	142478	50	standard	hexagonal flange rear mount	71	
56 K 611-272 N5	143243	50	standard	hexagonal flange rear mount	72	

Cable Connectors - Flexible Cables



Straight Plug, clamp

Flexible Cables

Rosenberger No.	Order No.	Sales Unit	Packaging	Remarks	Cable Group	
56 S 106-006 N5	139831	50	standard	captivated center contact	06, 07, 08	
56 S 105-015 N5	139834	25	standard		15, 17	



Straight Plug, crimp

Flexible Cables

Rosenberger No.	Order No.	Sales Unit	Packaging	Remarks	Cable Group	
56 S 107-802 N5	107976	50	standard	length 24.2 mm	02	
56 S 107-803 N5	101568	25	standard	length 24.2 mm	03	
56 S 107-106 N5	142485	25	standard	length 28.6 mm	06	
	169999	100	standard		06	
56 S 107-108 N5	142486	25	standard	length 28.6 mm	07, 08	
	160047	100	standard		07, 08	
56 S 101-115 N5	108649	50	standard		15	
56 S 101-117 N5	106490	50	standard		17	

Right Angle Plug, clamp

Flexible Cables

Rosenberger No.	Order No.	Sales Unit	Packaging	Cable Group	
56 S 201-006 N5	153942	25	standard	06, 07, 08	
56 S 201-015 N5	139883	25	standard	15, 17	



Right Angle Plug, solder crimp

Flexible Cables

Rosenberger No.	Order No.	Sales Unit	Packaging	Cable Group	
56 S 207-302 N5	144725	25	box	02	
56 S 207-303 N5	144726	25	box	03	
56 S 209-306 N5	159698	50	box	06	
56 S 209-308 N5	159773	100	box	07, 08	

Straight Jack, crimp

Flexible Cables

Rosenberger No.	Order No.	Sales Unit	Packaging	Cable Group	
56 K 107-802 N5	135347	25	standard	02	
56 K 107-106 N5	137794	25	standard	06	



Panel Jack, crimp, 4-hole flange

Flexible Cables

Rosenberger No.	Order No.	Sales Unit	Packaging	Remarks	Cable Group	
56 K 407-802 N5	104005	25	standard	4-hole flange 17.5 mm 4 x M 2.5	02	

Panel Jack, crimp, hexagonal flange

Flexible Cables

Rosenberger No.	Order No.	Sales Unit	Packaging	Remarks	Cable Group	
56 K 607-802 N5	106769	50	standard	hexagonal flange rear mount	02	
56 K 607-803 N5	107747	50	standard	hexagonal flange rear mount	03	
56 K 607-106 N5	142484	50	standard	hexagonal flange rear mount	06	
56 K 607-108 N5	146245	50	standard	hexagonal flange rear mount	07, 08	

Panel Connectors - Solder End

Panel Jack, round flange

Solder End

Rosenberger No.	Order No.	Sales Unit	Packaging	Remarks	
56 K 504-200 N5	103973	25	standard	round flange front mount length 26.5 mm	
56 K 508-200 N5	152199	25	standard	round flange front mount length 33.0 mm pressurized	

Panel Jack, 4-hole flange

Solder End

Rosenberger No.	Order No.	Sales Unit	Packaging	Remarks	
56 K 404-200 N5	153103	50	standard	4-hole flange 17.5 mm 4 x Ø 3.1 mm	

Right Angle Panel Jack, 4-hole flange

Solder End

Rosenberger No.	Order No.	Sales Unit	Packaging	Remarks	
56 K 201-200 N5	156802	25	standard	4-hole flange 17.5 mm 4 x Ø 3.1 mm	

Panel Connectors - Coaxial End

Panel Jack, 4-hole flange

Coaxial End

Rosenberger No.	Order No.	Sales Unit	Packaging	Remarks	
56 K 405-500 N5	144323	25	standard	4-hole flange 17.5 mm 4 x Ø 3.2 mm	

PCB Connectors - Solder Pin

Right Angle Jack, PCB

Solder Pin

Rosenberger No.	Order No.	Sales Unit	Packaging	Remarks	
56 K 201-400 A5	103989	50	blister	round pins	

Adaptors

Adaptors TNC 50 Ω - TNC 50 Ω

Rosenberger No.	Order No.	Sales Unit	Packaging	Remarks	
56 S 101-S00 N5	159997	1	standard	TNC male - male	
56 K 101-K00 N5	101507	1	standard	TNC female - female	
56 K 501-K00 N5	104699	1	standard	TNC female - female round flange	
56 S 201-K00 N5	103771	1	standard	TNC male - female right angle	
56 S 301-K00 N5	154225	1	standard	TNC female - male - female T-adaptor	



Adaptors TNC 50 Ω - SMA

Rosenberger No.	Order No.	Sales Unit	Packaging	Remarks	
56 S 132-K00 L5	192179	1	standard	TNC male - SMA female	
56 K 132-K00 L5	108760	1	standard	TNC female - SMA female	
32 S 156-S00 L5	104498	1	standard	SMA male - TNC male	
32 S 156-K00 L5	107063	1	standard	SMA male - TNC female	

Adaptors TNC 50 Ω - BNC 50 Ω

Rosenberger No.	Order No.	Sales Unit	Packaging	Remarks	
56 S 151-K00 N5	139867	1	standard	TNC male - BNC female	
51 S 156-S00 N5	139836	1	standard	BNC male - TNC male	
51 S 156-K00 N5	102737	1	standard	BNC male - TNC female	
51 K 156-K00 N5	139851	1	standard	BNC female - TNC female	

Adaptors TNC 50 Ω - N 50 Ω

Rosenberger No.	Order No.	Sales Unit	Packaging	Remarks	
56 S 153-K00 N5	148789	1	standard	TNC male - N female	
53 K 156-K00 N5	144501	1	standard	N female - TNC female	
53 S 156-K00 N5	107348	1	standard	N male - TNC female	

Adaptors TNC 50 Ω - QN

Rosenberger No.	Order No.	Sales Unit	Packaging	Remarks	
153Q S 156-K00 N5	195151	1	standard	QN male - TNC female	

Terminations

Termination Plug

Rosenberger No.	Order No.	Sales Unit	Packaging	Remarks	Return Loss	
56 S 1RR-001 N4	145665	1	standard	1 Watt Frequency: DC to 2 GHz	≥ 20.8 dB @ DC to 1 GHz ≥ 15.6 dB @ 1 GHz to 2 GHz	

Accessories

Protection Cap

Rosenberger No.	Order No.	Sales Unit	Packaging	Remarks	
56 Z 112-000 N	139885	25	standard	male with chain	

Interface Dimensions TNC 75 Ω

Code 76

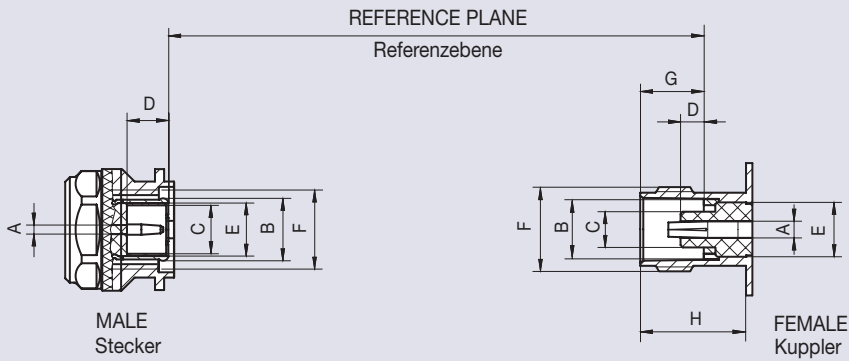

	Male Stecker		Female Kuppler	
	min.	max.	min.	max.
A	Ø 1.32	Ø 1.37	Ø 2.14 nom.	
B	1)		Ø 8.10	Ø 8.15
C	Ø 4.83	–	–	Ø 4.72
D	5.28	5.79	2.50 nom.	
E	Ø 7.00 nom.		Ø 7.00 nom.	
F	7/16-28 UNEF-2B		7/16-28 UNEF-2A	
G	–	–	8.31	8.51
H	–	–	10.52	–

Dimensions in mm

¹⁾ Resilient, dimension to meet electrical and mechanical requirements

50 Ω and 75 Ω connector types are intermateable without any restrictions within TNC.

50 Ω und 75 Ω TNC Steckverbinder sind innerhalb der Serie steckkompatibel.

Features

- ▶ Interface according to IEC 60169-17, MIL-PRF-39012, DIN EN 122200
- ▶ Frequency range DC to 4 GHz (max.), DC to 1.5 GHz (opt.)
- ▶ Return loss (cable connector straight) ≥ 20 dB (typ.)
- ▶ Impedance 75 Ω
- ▶ Screw-on coupling

Product Range

Connectors are available on request

Technical Data TNC 75 Ω

Code 76

Applicable standards Anwendbare Normen	
Interface according to Interface gemäß	IEC 60169-17, MIL-PRF-39012, DIN EN 122200
Electrical data Elektrische Daten	
Impedance Wellenwiderstand	75 Ω
Frequency range Frequenzbereich	DC to 4 GHz (max.) DC to 1.5 GHz (opt.)
Return loss (cable connector straight) Rückflusdämpfung (Kabelsteckverbinder gerade)	≥ 20 dB (typ.)
Insertion loss Dämpfung	≤ 0.1 × √f (GHz) dB
Insulation resistance Isolationswiderstand	≥ 5 GΩ
Center contact resistance Übergangswiderstand Innenleiter	≤ 1.5 mΩ
Outer contact resistance Übergangswiderstand Außenleiter	≤ 1 mΩ
Test voltage Prüfspannung	1500 V rms
Working voltage Betriebsspannung	500 V rms
Power handling Leistungsbelastbarkeit	80 W @ 2 GHz
Mechanical data Mechanische Daten	
Mating cycles Steckzyklen	≥ 500
Center contact captivation Innenleiter Haltekraft	axial: ≥ 27 N
Coupling test torque Prüfdrehmoment	≤ 1.7 Nm
Coupling torque recommended Drehmoment empfohlen	0.46 Nm to 0.69 Nm
Environmental data Umweltdaten	
Temperature range Temperaturbereich	-65 °C to +165 °C
Thermal shock Temperaturzyklen	MIL-STD-202, Method 107, Condition B
Climatic category Klimakategorie	IEC 60068-2-1 65/165/21
Corrosion resistance Korrosionsbeständigkeit	MIL-STD-202, Method 101, Condition B
Moisture resistance Feuchtigkeitsbeständigkeit	MIL-STD-202, Method 106
Vibration Vibration	MIL-STD-202, Method 204, Condition B
Shock Schock	MIL-STD-202, Method 213, Condition G
Max. soldering temperature (PCB connectors) Max. Löttemperatur (Leiterplattensteckverbinder)	IEC 61760-1, +260 °C for 10 sec.
Materials Materialien	
Spring loaded contact parts Federnde Kontaktteile	CuBe / CuSn, Au plating
Center contact Innenleiter	CuZn, Au plating
Outer contact Außenleiter	CuZn, Ni / white bronze plating
Crimping ferrule Crimphülse	Cu, white bronze plating
Dielectric Dielektrikum	PTFE
Gasket Dichtung	Rubber

Rosenberger connectors generally fulfill the indicated technical data. Individual values of connectors may deviate depending upon application, design, type of cable, assembly method and workmanship. Data sheets for particular products can be downloaded on our website or can be provided on request from your Rosenberger sales partner.

Rosenberger-Steckverbinder erfüllen grundsätzlich die hier angegebenen technischen Daten. Je nach Anwendung, Bauart, Kabeltyp, Montageart und -ausführung können einzelne Werte der Steckverbinder hiervon abweichen. Datenblätter zu einzelnen Produkten können Sie von unserer Website herunterladen oder auf Anfrage von Ihrem Rosenberger-Ansprechpartner erhalten.

N



N coaxial connectors are reliable screw-on connectors with high degree of protection and excellent intermodulation. Due to their mechanical stability and weather resistance N connectors are suitable for outdoor applications – 50 Ω versions up to max. 11 GHz, 75 Ω versions up to max. 6 GHz. 50 Ω and 75 Ω connectors are not intermateable.

N-Koaxial-Steckverbinder sind zuverlässige Schraubsteckverbinder mit hohem Reflexionsgrad und ausgezeichneter Intermodulation. Aufgrund hoher mechanischer Stabilität und ausgezeichneter Witterungsbeständigkeit sind sie besonders für Outdoor-Anwendungen geeignet, wobei 50 Ω -Steckverbinder bis max. 11 GHz, 75 Ω -Steckverbinder bis max. 6 GHz eingesetzt werden können. Die 50 Ω - und 75 Ω -Versionen sind nicht steckkompatibel.

N 50 Ω

N 75 Ω



Interface Dimensions N 50 Ω

Code 53

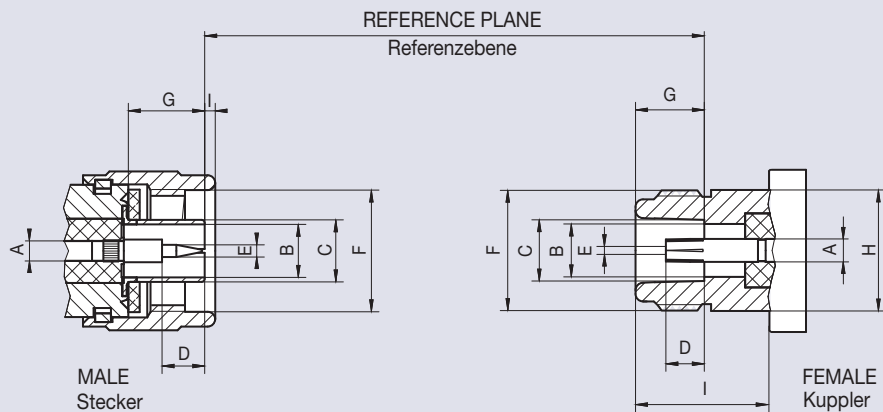

	Male Stecker		Female Kuppler	
	min.	max.	min.	max.
A	Ø 3.04 nom.		Ø 3.04 nom.	
B	Ø 7.00 nom.		Ø 7.00 nom.	
C	–	Ø 8.027	Ø 8.03	Ø 8.13
D	5.28	–	4.75	5.26
E	Ø 1.60	Ø 1.676	1)	
F	5/8-24 UNEF-2B		5/8-24 UNEF-2A	
G	9.25	–	9.15	9.19
H	–	–	–	Ø 15.93
I	0.41	1.52	10.72	–

Dimensions in mm

¹⁾ Resilient, dimension to meet electrical and mechanical requirements

N 50 Ω and RPC-N 50 Ω connectors are fully intermateable.

N 50 Ω und RPC-N 50 Ω-Steckverbinder sind steckkompatibel.

Features

- ▶ Interface according to IEC 61169-16, MIL-PRF-39012, CECC 22210
- ▶ Frequency range DC to 11 GHz
- ▶ Return loss (cable connector straight) ≥ 26 dB (typ.)
- ▶ Impedance 50 Ω
- ▶ Screw-on coupling
- ▶ N and RPC-N -50 Ω connectors are intermateable

Product Range

- ▶ Cable connectors
- ▶ Panel connectors
- ▶ Power Splitters
- ▶ Surge Arresters
- ▶ Adaptors
- ▶ Terminations
- ▶ Accessories

Technical Data N 50 Ω

Code 53

Applicable standards Anwendbare Normen	
Interface according to Interface gemäß	IEC 61169-16, MIL-PRF-39012, CECC 22210
Electrical data Elektrische Daten	
Impedance Wellenwiderstand	50 Ω
Frequency range Frequenzbereich	DC to 11 GHz
Return loss (cable connector straight) Rückflusdämpfung (Kabelsteckverbinder gerade)	≥ 26 dB (typ.)
Insertion loss Dämpfung	≤ 0.1 × √f (GHz) dB
Insulation resistance Isolationswiderstand	≥ 5 GΩ
Center contact resistance Übergangswiderstand Innenleiter	≤ 1 mΩ
Outer contact resistance Übergangswiderstand Außenleiter	≤ 0.25 mΩ
Working voltage Betriebsspannung	500 V rms
Power handling Leistungsbelastbarkeit	1000 W @ 1 GHz 700 W @ 2 GHz
RF leakage - Interface Schirmdämpfung	≥ 128 dB @ DC to 1 GHz
Intermodulation 3rd order Intermodulation 3. Ordnung	≤ -155 dBc (2 x 43 dBm)
Mechanical data Mechanische Daten	
Mating cycles Steckzyklen	≥ 500
Coupling nut retention Überwurfmutter Haltekraft	≥ 450 N
Center contact captivation Innenleiter Haltekraft	axial: ≥ 28 N radial: ≥ 3 Ncm
Coupling test torque Prüfdrehmoment	≤ 1.7 Nm
Coupling torque recommended Drehmoment empfohlen	0.7 Nm to 1.1 Nm
Environmental data Umweltdaten	
Temperature range Temperaturbereich	-65 °C to +165 °C
Thermal shock Temperaturzyklen	MIL-STD-202, Method 107, Condition B
Climatic category Klimakategorie	IEC 60068-2-1 65/165/21
Degree of protection (mated pair) Schutzgrad (gekoppeltes Paar)	IEC 60529, IP 68
Corrosion resistance Korrosionsbeständigkeit	MIL-STD-202, Method 101, Condition B
Moisture resistance Feuchtigkeitsbeständigkeit	MIL-STD-202, Method 106
Vibration Vibration	MIL-STD-202, Method 204, Condition B
Shock Schock	MIL-STD-202, Method 213, Condition I
Max. soldering temperature (PCB connectors) Max. Löttemperatur (Leiterplattensteckverbinder)	IEC 61760-1, +260 °C for 10 sec.
Materials Materialien	
Spring loaded contact parts Federnde Kontaktteile	CuBe, Au plating
Center contact Innenleiter	CuZn, Au / Ag plating
Outer contact Außenleiter	CuZn, Ag / white bronze plating
Crimping ferrule Crimphülse	Cu, white bronze plating
Dielectric Dielektrikum	PTFE
Gasket Dichtung	Rubber

Rosenberger connectors generally fulfill the indicated technical data. Individual values of connectors may deviate depending upon application, design, type of cable, assembly method and workmanship. Data sheets for particular products can be downloaded on our website or can be provided on request from your Rosenberger sales partner.

Rosenberger-Steckverbinder erfüllen grundsätzlich die hier angegebenen technischen Daten. Je nach Anwendung, Bauart, Kabeltyp, Montageart und -ausführung können einzelne Werte der Steckverbinder hiervon abweichen. Datenblätter zu einzelnen Produkten können Sie von unserer Website herunterladen oder auf Anfrage von Ihrem Rosenberger-Ansprechpartner erhalten.

Cable Connectors - Semi-Rigid Cables

Straight Plug, solder

Semi-Rigid Cables

Rosenberger No.	Order No.	Sales Unit	Packaging	Remarks	Cable Group
53 S 101-272 N5	102060	50	standard	length 24.3 mm	72
53 S 101-273 B5	102374	25	standard	length 30.1 mm	73



Right Angle Plug, solder

Semi-Rigid Cables

Rosenberger No.	Order No.	Sales Unit	Packaging	Cable Group
53 S 205-272 N5	285191	50	standard	72



Panel Jack, solder, 4-hole flange

Semi-Rigid Cables

Rosenberger No.	Order No.	Sales Unit	Packaging	Remarks	Cable Group
53 K 415-272 N5	188733	25	blister	4-hole flange 25.4 mm 4 x Ø 3.4 mm	72



Panel Jack, solder, round flange

Semi-Rigid Cables

Rosenberger No.	Order No.	Sales Unit	Packaging	Remarks	Cable Group
53 K 517-271 N5	193334	25	standard	round flange rear mount length 28.0 mm	71
53 K 504-272 N5	100464	50	standard	round flange rear mount length 33.0 mm	72
53 K 504-273 N5	106622	25	standard	round flange rear mount length 32.3 mm	73



Cable Connectors - Flexible Cables





Straight Plug, clamp

Flexible Cables

Rosenberger No.	Order No.	Sales Unit	Packaging	Remarks	Cable Group	
53 S 114-006 N5	102526	25	standard	captivated center contact	06, 07, 08	
53 S 102-015 N5	107244	25	standard	captivated center contact	15, 17	



Straight Plug, crimp

Flexible Cables

Rosenberger No.	Order No.	Sales Unit	Packaging	Cable Group	
53 S 107-802 N5	105231	25	standard	02	
53 S 107-803 N5	106202	25	standard	03	
	144148	100	standard	03	
53 S 107-106 N5	104461	50	standard	06	
	100961	100	standard	06	
53 S 107-108 N5	106754	50	standard	07, 08	
	105972	100	standard	07, 08	
53 S 101-115 N5	183093	100	standard	15	
53 S 101-117 N5	100456	1	standard	17	
	108219	50	standard	17	
53 S 101-1N9 N5	183094	50	standard	N9	



Right Angle Plug, solder crimp

Flexible Cables

Rosenberger No.	Order No.	Sales Unit	Packaging	Cable Group	
53 S 205-306 N5	105549	50	standard	06	
53 S 205-308 N5	189313	50	standard	07, 08	
53 S 205-315 N5	104721	25	standard	15	
53 S 205-317 N5	108265	50	standard	17	



Straight Jack, crimp

Flexible Cables

Rosenberger No.	Order No.	Sales Unit	Packaging	Cable Group	
53 K 107-106 N5	182065	50	standard	06	
53 K 107-108 N5	182066	50	standard	07, 08	
53 K 101-115 N5	181621	50	standard	15	
53 K 101-117 N5	181622	25	standard	17	



Panel Jack, crimp, 4-hole flange

Flexible Cables

Rosenberger No.	Order No.	Sales Unit	Packaging	Remarks	Cable Group	
53 K 407-106 N5	135179	25	standard	4-hole flange 25.4 mm 4 x Ø 3.4 mm	06	
53 K 407-108 N5	135898	25	standard	4-hole flange 25.4 mm 4 x Ø 3.4 mm	07, 08	
53 K 401-115 N5	108165	50	standard	4-hole flange 25.4 mm 4 x Ø 3.4 mm	15	
53 K 401-117 N5	103717	25	standard	4-hole flange 25.4 mm 4 x Ø 3.4 mm	17	

Panel Jack, crimp, round flange

Flexible Cables

Rosenberger No.	Order No.	Sales Unit	Packaging	Remarks	Cable Group	
53 K 517-802 N5	192936	50	standard	round flange rear mount length 31.5 mm	02	
53 K 517-803 N5	203703	50	standard	round flange rear mount length 31.5 mm	03	
53 K 507-106 N5	135941	50	standard	round flange rear mount length 41.9 mm	06	
53 K 507-108 N5	137264	50	standard	round flange rear mount length 41.9 mm	07, 08	
53 K 501-115 N5	102775	25	standard	round flange rear mount length 42.3 mm	15	
53 K 501-117 N5	103463	25	standard	round flange rear mount length 42.3 mm	17	

Panel Connectors - Solder End



Panel Plug, 4-hole flange

Solder End

Rosenberger No.	Order No.	Sales Unit	Packaging	Remarks	
53 S 401-200 N5	100339	25	blister	4-hole flange 25.4 mm 4 x Ø 3.4 mm	

Panel Jack, 4-hole flange

Solder End

Rosenberger No.	Order No.	Sales Unit	Packaging	Remarks	
53 K 401-200 N5	264738	25	standard	4-hole flange 25.4 mm 4 x Ø 3.4 mm	
	181237	100	standard		
53 K 403-200 N5	108199	25	standard	4-hole flange 17.5 mm 4 x Ø 3.2 mm	



Right Angle Panel Jack, 4-hole flange

Solder End

Rosenberger No.	Order No.	Sales Unit	Packaging	Remarks	
53 K 201-200 N5	102223	25	standard	4-hole flange 25.4 mm 4 x Ø 3.4 mm	

Panel Jack, round flange

Solder End

Rosenberger No.	Order No.	Sales Unit	Packaging	Remarks	
53 K 501-200 N5	147907	25	standard	round flange front mount length 36.8 mm pressurized	
53 K 505-200 N5	108468	25	standard	round flange rear mount length 35.9 mm	

Panel Connectors - Stripline

Panel Jack, 4-hole flange

Stripline

Rosenberger No.	Order No.	Sales Unit	Packaging	Remarks	
53 K 405-600 N5	149487	25	blister	4-hole flange 25.4 mm 4 x Ø 3.4 mm	

Panel Connectors - Microstrip

Panel Jack, 4-hole flange



Microstrip

Rosenberger No.	Order No.	Sales Unit	Packaging	Remarks	
53 K 401-800 N5	149488	50	standard	4-hole flange 25.4 mm 4 x Ø 3.3 mm accepts SMA-transition pins, Ø 0.91 mm	

Panel Connectors - Coaxial End

Panel Jack, 4-hole flange

Coaxial End

Rosenberger No.	Order No.	Sales Unit	Packaging	Remarks	
53 K 409-500 N5	138197	25	standard	4-hole flange 25.4 mm 4 x Ø 3.4 mm length 36.4 mm	
53 K 413-500 N5	139490	25	blister	4-hole flange 17.5 mm 4 x Ø 3.2 mm length 38.6 mm	
53 K 465-500 N5	149378	25	blister	4-hole flange 17.5 mm 4 x Ø 3.2 mm length 30.0 mm	

Panel Jack, round flange

Coaxial End



Rosenberger No.	Order No.	Sales Unit	Packaging	Remarks	
53 K 505-500 N5	100421	50	blister	round flange rear mount press-in length 26.8 mm	

Adaptors



Adaptors N 50 Ω - N 50 Ω

Rosenberger No.	Order No.	Sales Unit	Packaging	Remarks	
53 S 101-S00 N5	105362	1	standard	N male - male	
53 S 101-K00 N5	106083	1	standard	N male - female	
53 K 102-K00 N5	255385	1	standard	N female - female	
53 K 401-K00 N5	100840	1	standard	N female - female 4-hole flange 25.4 mm 4 x Ø 3.4 mm	
53 K 503-K00 N5	147625	1	standard	N female - female round flange	
53 K 502-K00 N5	107847	1	standard	N female - female round flange pressurized	
53 S 201-K00 N5	102052	1	standard	N male - female right angle	
53 S 301-K00 N5	100234	1	standard	N female - male - female T-adaptor	
53 K 301-K00 N5	103215	1	standard	N female - female - female T-adaptor	

Adaptors N 50 Ω - QN

Rosenberger No.	Order No.	Sales Unit	Packaging	Remarks	
153Q S 153-K00 N5	162704	1	standard	QN male - N female	
153Q K 153-S00 N5	162718	1	standard	QN female - N male	
153Q K 153-K00 N5	162713	1	standard	QN female - N female	

Adaptors N 50 Ω - SnapN

Rosenberger No.	Order No.	Sales Unit	Packaging	Remarks	
53Q S 153-K00 N5	167684	1	standard	SnapN male - N male	
53Q K 153-S00 N5	166862	1	standard	SnapN female - N male	



Adaptors N 50 Ω - P-SMP

Rosenberger No.	Order No.	Sales Unit	Packaging	Remarks	
119 K 153-K00 L5	210513	1	standard	P-SMP female - N female	

Adaptors N 50 Ω - SMA

Rosenberger No.	Order No.	Sales Unit	Packaging	Remarks	
53 S 132-K00 L5	189568	1	standard	N male - SMA female	
32 S 153-S00 L5	102934	1	standard	SMA male - N male	
53 K 132-K00 L5	108780	1	standard	N female - SMA female	
32 S 153-K00 L5	101424	1	standard	SMA male - N female	
32 S 453-K00 L5	107096	1	standard	SMA male - N female 4-hole flange 25.4 mm 4 x Ø 3.4 mm	
32 K 453-K00 L5	100755	1	standard	SMA female - N female 4-hole flange 25.4 mm 4 x Ø 3.4 mm	



Adaptors N 50 Ω - QMA

Rosenberger No.	Order No.	Sales Unit	Packaging	Remarks	
28 S 153-K00 N5	166928	1	standard	QMA male - N 50 Ω female	
28 K 153-K00 N5	166457	1	standard	QMA female - N 50 Ω female	



Adaptors N 50 Ω - BNC 50 Ω

Rosenberger No.	Order No.	Sales Unit	Packaging	Remarks	
53 S 151-K00 N5	107599	1	standard	N male - BNC female	
53 K 151-K00 N5	139881	1	standard	N female - BNC female	
51 S 153-K00 N5	139877	1	standard	BNC male - N female	
51 S 153-S00 N5	104872	1	standard	BNC male - N male	

Adaptors N 50 Ω - TNC 50 Ω

Rosenberger No.	Order No.	Sales Unit	Packaging	Remarks	
53 S 156-K00 N5	107348	1	standard	N male - TNC female	
56 S 153-K00 N5	148789	1	standard	TNC male - N female	
53 K 156-K00 N5	144501	1	standard	N female - TNC female	



Adaptors N 50 Ω - C 50 Ω

Rosenberger No.	Order No.	Sales Unit	Packaging	Remarks	
53 S 152-K00 N5	142572	1	standard	N male - C female	
52 S 153-K00 N3	142586	1	standard	C male - N female	

Adaptors N 50 Ω - 7-16

Rosenberger No.	Order No.	Sales Unit	Packaging	Remarks	
53 S 160-SIM N1	253033	1	standard	N male - 7-16 male	
53 S 160-KIM N1	238488	1	standard	N male - 7-16 female	
53 K 160-KIM N1	263127	1	standard	N female - 7-16 female	
60 S 153-KIM N1	238486	1	standard	7-16 male - N female	

Adaptors N 50 Ω - 4.3-10

Rosenberger No.	Order No.	Sales Unit	Packaging	Remarks	
53 K 164-S00 N1	256044	1	standard	N female - 4.3-10 male screw type	
53 S 164-K00 N1	255910	1	standard	N male - 4.3-10 female	
53 S 164-S00 N1	255912	1	standard	N male - 4.3-10 male screw type	

Adaptors N 50 Ω - 4.1-9.5

Rosenberger No.	Order No.	Sales Unit	Packaging	Remarks	
65 S 153-KIM N1	264916	1	standard	4.1-9.5 male - N female	
53 S 165-SIM N1	266929	1	standard	N male - 4.1-9.5 male	

Adaptors N 50 Ω - MCX

Rosenberger No.	Order No.	Sales Unit	Packaging	Remarks	
29 S 153-S00 Z5	102471	1	standard	MCX male - N male	
29 S 153-K00 Z5	100499	1	standard	MCX male - N female	
29 K 153-S00 Z5	104497	1	standard	MCX female - N male	
29 K 153-K00 Z5	101934	1	standard	MCX female - N female	

Adaptors N 50 Ω - SMB



Rosenberger No.	Order No.	Sales Unit	Packaging	Remarks	
59 S 153-S00 L5	196198	1	standard	SMB male - N male	
59 S 153-K00 L5	196197	1	standard	SMB male - N female	
59 K 153-S00 L5	104667	1	standard	SMB female - N male	
59 K 153-K00 L5	196193	1	standard	SMB female - N female	

Adaptors N 50 Ω - FME



Rosenberger No.	Order No.	Sales Unit	Packaging	Remarks	
26 S 153-S00 A1	102631	1	standard	FME male - N male	

Terminations

Termination Plug



Rosenberger No.	Order No.	Sales Unit	Packaging	Remarks	Return Loss	
53 S 1RR-001 N3	143402	25	blister	1 Watt Frequency: DC to 4 GHz	≥ 23.1 dB @ DC to 4 GHz	
53 S 17R-001 N3	149523	1	standard	1 Watt Frequency: DC to 12.4 GHz	≥ 32.2 dB @ DC to 1 GHz ≥ 26.4 dB @ 1 GHz to 2 GHz ≥ 20.8 dB @ 2 GHz to 12.4 GHz	
53 S 15R-005 N3	100418	1	standard	5 Watt Frequency: DC to 3 GHz	≥ 20.8 dB @ DC to 3 GHz	

Termination Jack

Rosenberger No.	Order No.	Sales Unit	Packaging	Remarks	Return Loss	
53 K 1RR-001 N3	102907	10	blister	1 Watt Frequency: DC to 4 GHz	≥ 23.1 dB @ DC to 4 GHz	
53 K 15R-005 N3	104226	1	standard	5 Watt Frequency: DC to 3 GHz	≥ 20.8 dB @ DC to 3 GHz	

Accessories

Protective Cap

Rosenberger No.	Order No.	Sales Unit	Packaging	Remarks	
53 Z 117-000 N	218644	50	standard	male without chain	
53 Z 113-001 N	153059	25	standard	male with cord	
53 Z 115-004 N	105718	10	standard	female with cord	

Shorting Cap Plug

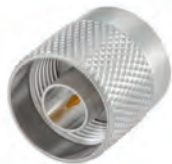
Rosenberger No.	Order No.	Sales Unit	Packaging	Remarks	
53 Z 111-000 N5	136955	5	standard	male	

Special Tools

Torque Wrench

Rosenberger No.	Order No.	Sales Unit	Packaging	Remarks	
53 W 008-000	104745	1	standard	N torque 1.1 Nm flat 18 mm	

Interface Dimensions N 75 Ω

Code 73

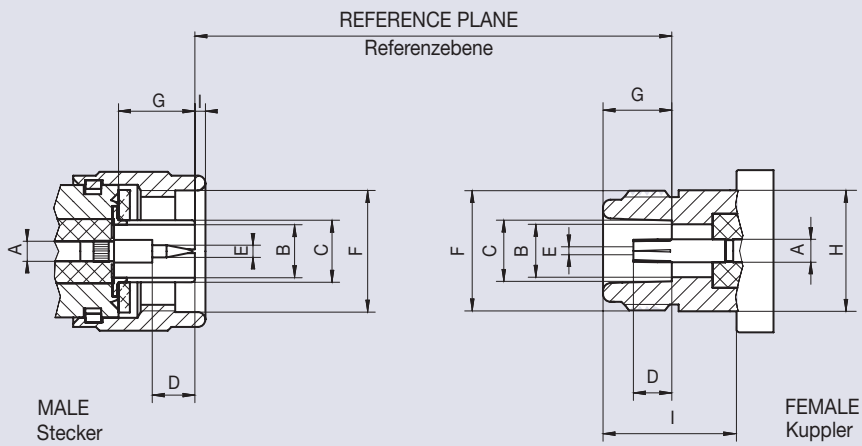

	Male Stecker		Female Kuppler	
	min.	max.	min.	max.
A	Ø 2.01 nom.		Ø 2.01 nom.	
B	Ø 7.00 nom.		Ø 7.00 nom.	
C	–	Ø 8.027	Ø 8.03	Ø 8.13
D	5.28	–	4.75	5.26
E	Ø 0.84	Ø 0.91	1)	
F	5/8-24 UNEF-2B		5/8-24 UNEF-2A	
G	9.25	–	9.05	9.19
H	–	–	–	Ø 15.93
I	0.41	1.52	10.72	–

Dimensions in mm

¹⁾ Resilient, dimension to meet electrical and mechanical requirements

N 75 Ω and RPC-N 75 Ω connectors are fully intermateable.

N 75 Ω und RPC-N 75 Ω-Steckverbinder sind steckkompatibel.

Features

- ▶ Interface according to IEC 61169-16 (Annex A)
- ▶ Frequency range DC to 6 GHz
- ▶ Return loss (cable connector straight) ≥ 26 dB (typ.)
- ▶ Impedance 75 Ω
- ▶ Screw-on coupling
- ▶ N and RPC-N -50 Ω connectors are intermateable

Product Range

- ▶ Cable connectors
- ▶ Panel connectors
- ▶ Adaptors

Technical Data N 75 Ω

Code 73

Applicable standards Anwendbare Normen	
Interface according to Interface gemäß	IEC 61169-16 (Annex A)
Electrical data Elektrische Daten	
Impedance Wellenwiderstand	75 Ω
Frequency range Frequenzbereich	DC to 6 GHz
Return loss (cable connector straight) Rückflussdämpfung (Kabelsteckverbinder gerade)	≥ 26 dB (typ.)
Insertion loss Dämpfung	≤ 0.1 × √f (GHz) dB
Insulation resistance Isolationswiderstand	≥ 5 GΩ
Center contact resistance Übergangswiderstand Innenleiter	≤ 1.5 mΩ
Outer contact resistance Übergangswiderstand Außenleiter	≤ 0.25 mΩ
Test voltage Prüfspannung	2500 V rms
Working voltage Betriebsspannung	1400 V rms
RF leakage - Interface Schirmdämpfung	≥ 128 dB @ DC to 1 GHz
Mechanical data Mechanische Daten	
Mating cycles Steckzyklen	≥ 500
Coupling nut retention Überwurfmutter Haltekraft	≥ 450 N
Center contact captivation Innenleiter Haltekraft	axial: ≥ 28 N radial: ≥ 3 Ncm
Coupling test torque Prüfdrehmoment	≤ 1.7 Nm
Coupling torque recommended Drehmoment empfohlen	0.7 Nm to 1.1 Nm
Environmental data Umweltdaten	
Temperature range Temperaturbereich	-65 °C to +165 °C
Thermal shock Temperaturzyklen	MIL-STD-202, Method 107, Condition B
Climatic category Klimakategorie	IEC 60068-2-1 65/165/21
Degree of protection (mated pair) Schutzgrad (gekoppeltes Paar)	IEC 60529, IP 68
Corrosion resistance Korrosionsbeständigkeit	MIL-STD-202, Method 101, Condition B
Moisture resistance Feuchtigkeitsbeständigkeit	MIL-STD-202, Method 106
Vibration Vibration	MIL-STD-202, Method 204, Condition B
Shock Schock	MIL-STD-202, Method 213, Condition I
Max. soldering temperature (PCB connectors) Max. Löttemperatur (Leiterplattensteckverbinder)	IEC 61760-1, +260 °C for 10 sec.
Materials Materialien	
Spring loaded contact parts Federnde Kontaktteile	CuBe, Au plating
Center contact Innenleiter	CuZn, Au plating
Outer contact Außenleiter	CuZn, white bronze plating
Crimping ferrule Crimphülse	Cu, white bronze plating
Dielectric Dielektrikum	PTFE
Gasket Dichtung	Rubber

Rosenberger connectors generally fulfill the indicated technical data. Individual values of connectors may deviate depending upon application, design, type of cable, assembly method and workmanship. Data sheets for particular products can be downloaded on our website or can be provided on request from your Rosenberger sales partner.

Rosenberger-Steckverbinder erfüllen grundsätzlich die hier angegebenen technischen Daten. Je nach Anwendung, Bauart, Kabeltyp, Montageart und -ausführung können einzelne Werte der Steckverbinder hiervon abweichen. Datenblätter zu einzelnen Produkten können Sie von unserer Website herunterladen oder auf Anfrage von Ihrem Rosenberger-Ansprechpartner erhalten.

QN



QN coaxial connectors (quick-lock N connectors) are based on the N connector interface with a frequency range up to 11 GHz. The quick-lock coupling mechanism enables reliable and easy connections 10 times faster than standard N in the tightest spaces, primarily in mobile base stations. Assembly tools are not necessary. QN and standard N connectors are not intermateable.

QN-Koaxial-Steckverbinder – Quick-Lock-N-Steckverbinder – basieren in Eigenschaften und Abmessungen auf der Serie N, der Frequenzbereich reicht bis 11 GHz. Der Quick-Lock-Einrastmechanismus ermöglicht zuverlässige, einfache und im Vergleich zu Standard N 10-fach schnellere Steckverbindungen auf engstem Raum, z. B. in Mobilfunk-Basisstationen. Werkzeuge sind nicht erforderlich. Steckkompatibilität zwischen den Serien QN und N ist nicht gegeben.

QN



Interface Dimensions QN

Code 153Q



Rosenberger is an authorized QLF[®] manufacturer.
 Rosenberger QN connectors fulfil the QLF[®] standard (Quick Lock Formula, a registered trademark).
 QLF[®] guarantees full intermateability between connectors produced by licensing agreement parties.
 Rosenberger as licensee is free to market QN connectors as QLF[®] products.
 For further information, please see: www.qf.info

Rosenberger ist autorisierter QLF[®]-Hersteller.
 Rosenberger QN-Steckverbinder entsprechen dem QLF[®]-Standard, der als Warenzeichen eingetragen ist.
 QLF[®] (Quick Lock Formula) stellt die Steckbarkeit von Produkten der Lizenzparteien sicher.
 Rosenberger ist als Lizenznehmer berechtigt, QN Steckverbinder als QLF[®]-Produkte zu vermarkten.
 Weitere Informationen unter: www.qf.info



Features

- ▶ Interface according to QLF[®] (Quick Lock Formula)
- ▶ Frequency range DC to 11 GHz
- ▶ Return loss (cable connector straight) ≥ 25 dB @ 6 GHz
- ▶ Minimum pitch: 20 mm
- ▶ Flexibility: 360° turnable
- ▶ Impedance 50 Ω
- ▶ Quick-lock coupling

Product Range

- ▶ Cable connectors
- ▶ Panel connectors
- ▶ Adaptors

Technical Data QN

Code 153Q

Applicable standards Anwendbare Normen	
Interface according to Interface gemäß	QLF® (Quick Lock Formula) Rosenberger is an authorized QLF® manufacturer
Electrical data Elektrische Daten	
Impedance Wellenwiderstand	50 Ω
Frequency range Frequenzbereich	DC to 11 GHz
Return loss (cable connector straight) Rückflussdämpfung (Kabelsteckverbinder gerade)	≥ 32 dB @ DC to 3 GHz ≥ 25 dB @ 3 GHz to 6 GHz ≥ 20 dB @ 6 GHz to 11 GHz
Insertion loss Dämpfung	≤ 0.05 x √f (GHz) dB
Insulation resistance Isolationswiderstand	≥ 5 GΩ
Center contact resistance Übergangswiderstand Innenleiter	≤ 1.5 mΩ
Outer contact resistance Übergangswiderstand Außenleiter	≤ 1.5 mΩ
Test voltage Prüfspannung	2500 V rms
Working voltage Betriebsspannung	1000 V rms
Power handling Leistungsbelastbarkeit	300 W @ 2.5 GHz
RF leakage - Interface Schirmdämpfung	≥ 90 dB @ DC to 3 GHz ≥ 80 dB @ 3 GHz to 6 GHz
Intermodulation 3rd order Intermodulation 3. Ordnung	≤ -155 dBc (2 x 43 dBm)
Mechanical data Mechanische Daten	
Mating cycles Steckzyklen	≥ 100
Interface retention force Interface Haltekraft	≥ 450 N
Engagement force Steckkraft	30 N (typ.)
Disengagement force Ziehkraft	30 N (typ.)
Pitch Packungsdichte	≥ 20 mm
Environmental data Umweltdaten	
Temperature range Temperaturbereich	-40 °C to +125 °C
Thermal shock Temperaturzyklen	IEC 60169-1, Sub-clause 16.4 (-40 °C / +125 °C)
Degree of protection (mated pair) Schutzgrad (gekoppeltes Paar)	IEC 60529, IP 68
Corrosion resistance Korrosionsbeständigkeit	MIL-STD-202, Method 101, Condition B
Vibration Vibration	MIL-STD-202, Method 204, Condition A
Shock Schock	MIL-STD-202, Method 213, Condition I
Max. soldering temperature (PCB connectors) Max. Löttemperatur (Leiterplattensteckverbinder)	IEC 61760-1, +260 °C for 10 sec.
Materials Materialien	
Spring loaded contact parts Federnde Kontaktteile	CuBe / CuSn, Au plating
Center contact Innenleiter	CuZn, Au plating
Outer contact Außenleiter	CuZn, white bronze plating
Body Gehäuse	CuZn, white bronze plating
Locking sleeve Verriegelungshülse	CuZn, white bronze plating
Crimping ferrule Crimphülse	Cu, white bronze plating
Dielectric Dielektrikum	PTFE
Gasket Dichtung	Silicone

Rosenberger connectors generally fulfill the indicated technical data. Individual values of connectors may deviate depending upon application, design, type of cable, assembly method and workmanship. Data sheets for particular products can be downloaded on our website or can be provided on request from your Rosenberger sales partner.

Rosenberger-Steckverbinder erfüllen grundsätzlich die hier angegebenen technischen Daten. Je nach Anwendung, Bauart, Kabeltyp, Montageart und -ausführung können einzelne Werte der Steckverbinder hiervon abweichen. Datenblätter zu einzelnen Produkten können Sie von unserer Website herunterladen oder auf Anfrage von Ihrem Rosenberger-Ansprechpartner erhalten.

Cable Connectors Semi-Rigid Cables

Straight Plug, solder

Semi-Rigid Cables

Rosenberger No.	Order No.	Sales Unit	Packaging	Cable Group	
153Q S 102-272 N5	161808	25	standard	72	

Right Angle Plug, solder

Semi-Rigid Cables

Rosenberger No.	Order No.	Sales Unit	Packaging	Cable Group	
153Q S 202-272 N5	165768	25	standard	72	

Panel Jack, solder, hexagonal flange



Semi-Rigid Cables

Rosenberger No.	Order No.	Sales Unit	Packaging	Remarks	Cable Group	
153Q K 601-272 N5	154046	25	standard	hexagonal flange rear mount	72	

Cable Connectors - Flexible Cables



Straight Plug, crimp

Flexible Cables

Rosenberger No.	Order No.	Sales Unit	Packaging	Cable Group	
153Q S 108-106 N5	165702	25	standard	06	
153Q S 108-108 N5	165741	25	standard	08	
153Q S 101-115 N5	165758	25	standard	15	



Right Angle Plug, solder-crimp

Flexible Cables

Rosenberger No.	Order No.	Sales Unit	Packaging	Cable Group	
153Q S 205-306 N5	165760	25	standard	06	
153Q S 205-308 N5	165761	25	standard	08	
153Q S 205-315 N5	165776	25	standard	15	

Panel Jack, crimp, hexagonal flange

Flexible Cables

Rosenberger No.	Order No.	Sales Unit	Packaging	Remarks	Cable Group	
153Q K 607-106 N5	156466	25	standard	hexagonal flange rear mount	06	
153Q K 607-108 N5	165729	25	standard	hexagonal flange rear mount	08	
153Q K 601-115 N5	165736	25	standard	hexagonal flange rear mount	15	

Panel Connectors - Solder End



Panel Jack, 4-hole flange

Solder End

Rosenberger No.	Order No.	Sales Unit	Packaging	Remarks	
153Q K 401-200 N5	152485	25	blister	4-hole flange 17.5 mm 4 x Ø 3.2 mm	

Adaptors

Adaptors QN - N 50 Ω

Rosenberger No.	Order No.	Sales Unit	Packaging	Remarks	
153Q S 153-K00 N5	162704	1	standard	QN male - N female	
153Q K 153-S00 N5	162718	1	standard	QN female - N male	
153Q K 153-K00 N5	162713	1	standard	QN female - N female	

Adaptors QN - 7-16

Rosenberger No.	Order No.	Sales Unit	Packaging	Remarks	
153Q K 160-S00 N5	204686	1	standard	QN female - 7-16 male	

Adaptors QN - TNC 50 Ω

Rosenberger No.	Order No.	Sales Unit	Packaging	Remarks	
153Q S 156-K00 N5	195151	1	standard	QN male - TNC female	

SnapN



SnapN coaxial connectors can be applied up to 11 GHz and are compatible to Standard N connectors: SnapN jacks (female) and Standard N plugs (male) are intermateable. The outer diameter of 16 mm – smaller compared to standard N interface – leads to higher packing densities, the quick-lock coupling mechanism enables reliable and easy connections 10 times faster than Standard N in the tightest spaces. Assembly tools are not necessary.

SnapN-Koaxial-Steckverbinder sind einsetzbar bis 11 GHz und rückwärtskompatibel zu Standard-N-Steckverbindern: SnapN-Kuppler können mit Standard-N-Steckern verbunden werden. Durch den im Vergleich zum Standard-N-Interface kleineren Außendurchmesser von 16 mm wird eine deutlich höhere Packungsdichte erreicht, der Quick-Lock-Einrastmechanismus ermöglicht zuverlässige, einfache und im Vergleich zu Standard N 10-fach schnellere Steckverbindungen auf engstem Raum. Werkzeuge sind nicht erforderlich.

SnapN



Interface Dimensions SnapN

Code 53Q

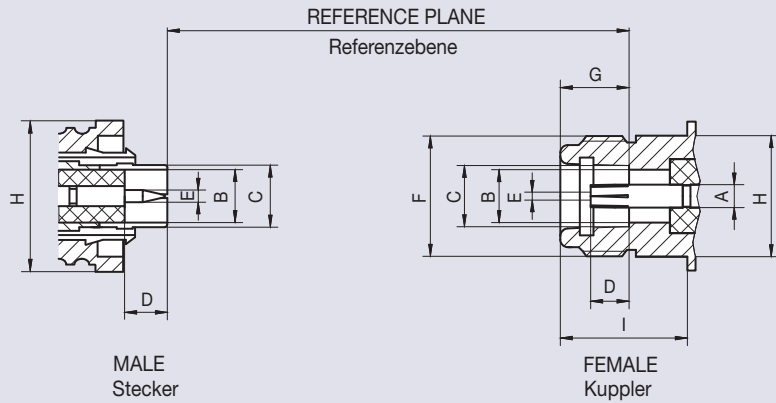

	Male Stecker		Female Kuppler	
	min.	max.	min.	max.
A	–	–		Ø 3.04 nom.
B	Ø 7.00 nom.		Ø 7.00 nom.	
C	Ø 8.20	Ø 8.38	Ø 8.027	Ø 8.13
D	5.33	–	4.75	5.26
E	Ø 1.60	Ø 1.676		¹⁾
F	–	–	5/8-24 UNEF-2A	
G	–	–	9.05	9.19
H	Ø 16.00 nom.		–	Ø 15.93
I	–	–	–	10.72

Dimensions in mm

¹⁾ Resilient, dimension to meet electrical and mechanical requirements

Please note: For locking and unlocking units, please always use the latching sleeve

Bitte beachten: Beim Ver- und Entriegeln unbedingt Hülse betätigen

Features

- ▶ Interface according to Rosenberger SnapN
- ▶ Frequency range DC to 11 GHz
- ▶ Return loss (cable connector straight) ≥ 25 dB @ 6 GHz
- ▶ Minimum pitch: 16 mm
- ▶ Flexibility: 360° turnable
- ▶ Impedance 50 Ω
- ▶ SnapN female mateable with N male
- ▶ Quick-lock coupling

Product Range

- ▶ Cable connectors
- ▶ Panel connectors
- ▶ Adaptors

Technical Data SnapN

Code 53Q

Applicable standards Anwendbare Normen	
Interface according to Interface gemäß	Rosenberger SnapN
Interface female according to Interface Kuppler gemäß	IEC 61169-16, CECC 22210, MIL-PRF-39012
Electrical data Elektrische Daten	
Impedance Wellenwiderstand	50 Ω
Frequency range Frequenzbereich	DC to 11 GHz
Return loss (cable connector straight) Rückflussdämpfung (Kabelsteckverbinder gerade)	≥ 32 dB @ DC to 3 GHz ≥ 25 dB @ 3 GHz to 6 GHz ≥ 20 dB @ 6 GHz to 11 GHz
Insertion loss Dämpfung	≤ 0.05 x √f (GHz) dB
Insulation resistance Isolationswiderstand	≥ 5 GΩ
Center contact resistance Übergangswiderstand Innenleiter	≤ 1 mΩ
Outer contact resistance Übergangswiderstand Außenleiter	≤ 1 mΩ
Working voltage Betriebsspannung	500 V rms
Power handling Leistungsbelastbarkeit	300 W @ 2.5 GHz
RF leakage - Interface Schirmdämpfung	≥ 90 dB @ DC to 3 GHz ≥ 80 dB @ 3 GHz to 6 GHz
Intermodulation 3rd order Intermodulation 3. Ordnung	≤ -155 dBc (2 x 43 dBm)
Mechanical data Mechanische Daten	
Mating cycles Steckzyklen	≥ 200
Center contact captivation Innenleiter Haltekraft	axial: ≥ 28 N radial: ≥ 3 Ncm
Engagement force Steckkraft	30 N (typ.)
Disengagement force Ziehkraft	30 N (typ.)
Pitch Packungsdichte	≥ 16 mm
Environmental data Umweltdaten	
Temperature range Temperaturbereich	-40 °C to +125 °C
Thermal shock Temperaturzyklen	IEC 60169-1, Sub-clause 16.4 (-40 °C / +125 °C)
Damp heat Feuchte Wärme	IEC 60169-1, Sub-clause 16.3
Climatic sequence Klimasequenz	IEC 60169-1, Sub-clause 16.2, 40/125/21
Vibration Vibration	MIL-STD-202, Method 204, Condition A
Shock Schock	MIL-STD-202, Method 213, Condition I
Max. soldering temperature (PCB connectors) Max. Löttemperatur (Leiterplattensteckverbinder)	IEC 61760-1, +260 °C for 10 sec.
Materials Materialien	
Spring loaded contact parts Federnde Kontaktteile	CuBe / CuSn, Au plating
Center contact Innenleiter	CuZn, Au plating
Outer contact Außenleiter	CuZn, white bronze plating
Body Gehäuse	CuZn, white bronze plating
Locking sleeve Verriegelungshülse	CuZn, white bronze plating
Crimping ferrule Crimphülse	Cu, white bronze plating
Dielectric Dielektrikum	PTFE
Gasket Dichtung	Silicone

Rosenberger connectors generally fulfill the indicated technical data. Individual values of connectors may deviate depending upon application, design, type of cable, assembly method and workmanship. Data sheets for particular products can be downloaded on our website or can be provided on request from your Rosenberger sales partner.

Rosenberger-Steckverbinder erfüllen grundsätzlich die hier angegebenen technischen Daten. Je nach Anwendung, Bauart, Kabeltyp, Montageart und -ausführung können einzelne Werte der Steckverbinder hiervon abweichen. Datenblätter zu einzelnen Produkten können Sie von unserer Website herunterladen oder auf Anfrage von Ihrem Rosenberger-Ansprechpartner erhalten.

Cable Connectors - Semi-Rigid Cables

Straight Plug, solder

Semi-Rigid Cables

Rosenberger No.	Order No.	Sales Unit	Packaging	Cable Group	
53Q S 101-272 B5	150672	50	standard	72	

Straight Panel Jack, solder

Semi-Rigid Cables

Rosenberger No.	Order No.	Sales Unit	Packaging	Remarks	Cable Group	
53Q K 501-272 N5	154738	50	standard	round flange rear mount length 33 mm	72	

Panel Connectors - Coaxial End



Straight Panel Jack, 4-hole flange

Solder End

Rosenberger No.	Order No.	Sales Unit	Packaging	Remarks	
53Q K 40A-500 N5	156040	50	standard	4-hole flange 19 mm 4 x Ø 3.4 mm	
53Q K 44F-500 N5	228644	25	standard	4-hole flange 17.5 mm 4 x Ø 3.2 mm	

Adaptors

Adaptors SnapN - N 50 Ω

Rosenberger No.	Order No.	Sales Unit	Packaging	Remarks	
53Q S 153-K00 N5	167684	1	standard	SnapN male - N female	
53Q K 153-S00 N5	166862	1	standard	SnapN female - N male	

Adaptors SnapN - RPC-N 50 Ω

Rosenberger No.	Order No.	Sales Unit	Packaging	Remarks	Return Loss	
53Q S 105-S00 S3	169219	1	standard	SnapN male - RPC-N 50 Ω male	≥ 26 dB @ DC to 11 GHz	
53Q S 105-K00 S3	159286	1	standard	SnapN male - RPC-N 50 Ω female	≥ 26 dB @ DC to 11 GHz	
53Q S 105-K20 S3	182044	1	standard	SnapN male - RPC-N 50 Ω female calibration adaptor	≥ 36 dB @ DC to 4 GHz ≥ 27 dB @ 4 GHz to 11 GHz	
53Q K 105-S00 S3	158124	1	standard	SnapN female - RPC-N 50 Ω male	≥ 28 dB @ DC to 11 GHz ≥ 26 dB @ 11 GHz to 18 GHz	
53Q K 105-S20 S3	182045	1	standard	SnapN female - RPC-N 50 Ω male calibration adaptor	≥ 36 dB @ DC to 4 GHz ≥ 27 dB @ 4 GHz to 11 GHz	
53Q K 105-K00 S3	158125	1	standard	SnapN female - RPC-N 50 Ω female	≥ 28 dB @ DC to 11 GHz ≥ 26 dB @ 11 GHz to 18 GHz	

4.3-10

4.1-9.5



The 4.3-10 connector system is designed to meet the rising performance needs of mobile network equipment e.g. to connect the RRU to the antenna.

Features of the 4.3-10 Connectors are compact connector sizes, best electrical performance, low PIM and coupling torque as well as the easy installation.

Three different coupling mechanisms of the plug connectors screw, quick-lock/push-pull and hand-screw types are mateable with all jack connectors.

Das 4.3-10 Steckverbindersystem wurde für die steigenden Effizienzanforderungen an Mobilfunknetze entworfen und findet Anwendung z.B. zwischen RRU und Antenne.

4.3-10 Steckverbinder zeichnen sich durch die kompakte Baugröße, bestmögliche elektrische Leistung, niedrige PIM, geringes Kupplungsdrehmoment sowie die einfache Installation aus.

Die drei verschiedenen Steckervarianten Screw, Quick-Lock/Push-Pull und Hand-Screw sind mit allen Kupplern steckbar.

4.3-10
4.1-9.5

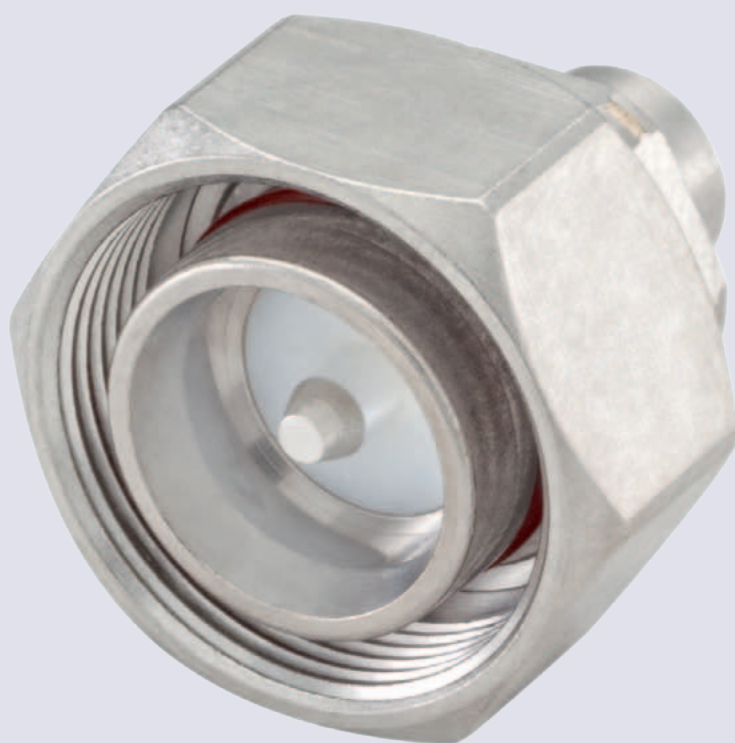

4.3-10

Interface Dimensions 4.3-10

Code 64

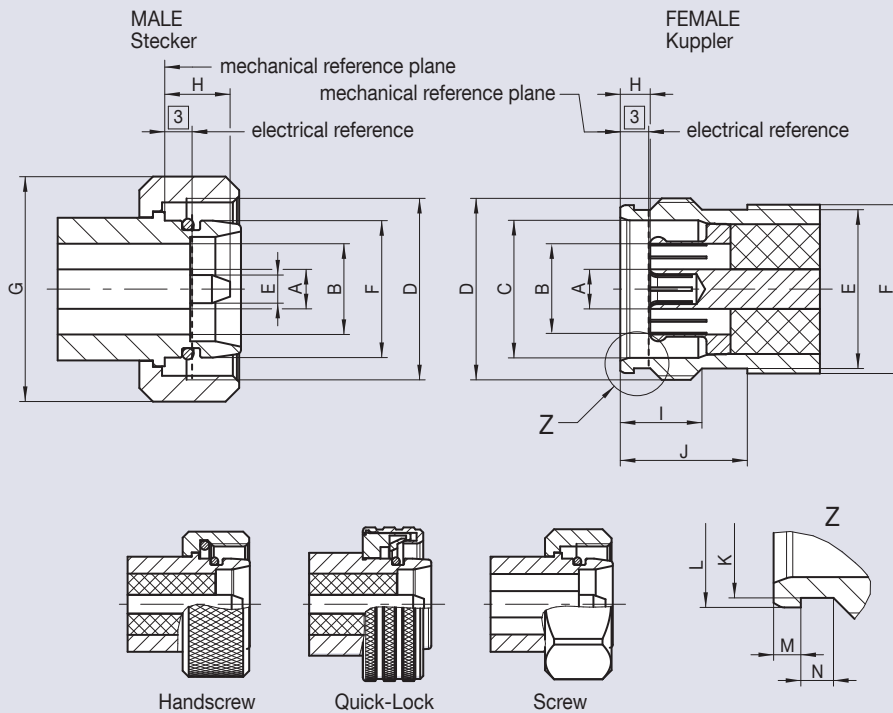

	Male Stecker		Female Kuppler	
	min.	max.	min.	max.
A	4.35 nom.		4.35 nom.	
B	10.00 nom.		9.80	10.20
C	-	-	15.13	15.19
D	M 20 x 1		M 20 x 1	
E	3.07	3.13	17.45	17.55
F	15.07	15.11	18.60	-
G	SW 22		-	-
H	-	8.00	3.10	3.50
I	-	-	8.70	9.00
J	-	-	13.90	14.10
K	-	-	17.40	17.50
L	-	-	18.44	18.50
M	-	-	1.44	1.50
N	-	-	1.70	1.90

Dimensions in mm

Three different coupling mechanisms of the 4.3-10 plugs screw, quick-lock/push-pull and hand-screw types are mateable with all 4.3-10 jacks.

Die drei verschiedenen 4.3-10-Steckervarianten Screw, Quick-Lock/Push-Pull und Hand-Screw sind mit allen 4.3-10-Kupplern koppelbar.

Features

- ▶ Interface according IEC 61169-54
- ▶ Frequency range DC to 12 GHz
- ▶ Return loss (cable connector straight) ≥ 36 dB @ DC to 4 GHz
- ▶ Minimum pitch: ≥ 25.4 mm
- ▶ Low PIM
- ▶ Screw, quick-lock/push-pull, hand-screw coupling

Product Range

- ▶ Cable connectors
- ▶ Panel connectors
- ▶ Adaptors

Technical Data 4.3-10

Code 64

Applicable standards Anwendbare Normen	
Interface according to Interface gemäß	IEC 61169-54
Electrical data Elektrische Daten	
Impedance Wellenwiderstand	50 Ω
Frequency range Frequenzbereich	DC to 12 GHz
Return loss (cable connector straight) Rückflusdämpfung (Kabelsteckverbinder gerade)	≥ 36 dB @ DC to 4 GHz ≥ 32 dB @ 4 GHz to 6 GHz
Insertion loss Dämpfung	≤ 0.05 x √f (GHz) dB
Insulation resistance Isolationswiderstand	≥ 5 GΩ
Center contact resistance Übergangswiderstand Innenleiter	≤ 1 mΩ
Outer contact resistance Übergangswiderstand Außenleiter	≤ 1 mΩ
Test voltage Prüfspannung	2500 V rms
Working voltage Betriebsspannung	500 V rms
Power handling Leistungsbelastbarkeit	500 W @ 2 GHz / 90 °C
RF leakage - Interface Schirmdämpfung	≥ 120 dB @ DC to 6 GHz (screw type) ≥ 90 dB @ DC to 3 GHz (hand-screw / quick-lock) ≥ 70 dB @ 3 GHz to 6 GHz (hand-screw / quick-lock)
Intermodulation 3rd order Intermodulation 3. Ordnung	≤ -160 dBc (2 x 46 dBm) @ 0.4 to 4 GHz ≤ -166 dBc (2 x 43 dBm) @ 0.4 to 4 GHz
Mechanical data Mechanische Daten	
Mating cycles Steckzyklen	≥ 100
Coupling nut retention Überwurfmutter Haltekraft	≥ 450 N
Center contact captivation Innenleiter Haltekraft	axial: ≥ 30 N radial: ≥ 5 Ncm
Engagement force Steckkraft	100 N (typ.)
Disengagement force Ziehkraft	80 N (typ.)
Coupling test torque Prüfdrehmoment	8 Nm
Coupling torque recommended Drehmoment empfohlen	5 Nm
Pitch Packungsdichte	≥ 25.4 mm
Environmental data Umweltdaten	
Temperature range Temperaturbereich	-55 °C to +90 °C
Thermal shock Temperaturzyklen	IEC 61169-1, Sub-clause 9.4.4
Damp heat Feuchte Wärme	IEC 61169-1, Sub-clause 9.4.3
Climatic category Klimakategorie	IEC 60068-2-1 55/155/56
Degree of protection (mated pair) Schutzgrad (gekoppeltes Paar)	IEC 60529, IP 68
Corrosion resistance Korrosionsbeständigkeit	ISO 21207 Method B
Vibration Vibration	IEC 61169-1, Sub-clause 9.3.3
Shock Schock	IEC 60068-2-27
Max. soldering temperature (PCB connectors) Max. Löttemperatur (Leiterplattensteckverbinder)	IEC 61760-1, +260 °C for 10 sec.
Materials Materialien	
Spring loaded contact parts Federnde Kontaktteile	CuBe / CuZnSi, Ag plating
Center contact Innenleiter	CuBe / CuZn, Ag plating
Outer contact Außenleiter	CuZnSi / CuZn, Ag / white bronze plating
Body Gehäuse	CuZn, white bronze plating
Coupling nut Überwurfmutter	CuZn, white bronze plating
Locking sleeve Verriegelungshülse	CuZn, white bronze plating
Dielectric Dielektrikum	PTFE
Gasket Dichtung	Rubber



Rosenberger connectors generally fulfill the indicated technical data. Individual values of connectors may deviate depending upon application, design, type of cable, assembly method and workmanship. Data sheets for particular products can be downloaded on our website or can be provided on request from your Rosenberger sales partner.

Rosenberger-Steckverbinder erfüllen grundsätzlich die hier angegebenen technischen Daten. Je nach Anwendung, Bauart, Kabeltyp, Montageart und -ausführung können einzelne Werte der Steckverbinder hiervon abweichen. Datenblätter zu einzelnen Produkten können Sie von unserer Website herunterladen oder auf Anfrage von Ihrem Rosenberger-Ansprechpartner erhalten.

Cable Connectors - Semi-Rigid Cables

Straight Plug, solder

Semi-Rigid Cables

Rosenberger No.	Order No.	Sales Unit	Packaging	Remarks	Cable Group	
64 S 101-273 N1	244613	25	standard	screw type	73	
64 S 131-273 N1	251104	25	standard	hand-screw type	73	
64 S 161-273 N1	272630	25	standard	quick-lock type	73	

Panel Jack, 4-hole flange

Semi-Rigid Cables

Rosenberger No.	Order No.	Sales Unit	Packaging	Remarks	Cable Group	
64 K 401-272 B1	258862	40	box	4-hole flange 25.4 mm 4 x Ø 3.4 mm	72	
64 K 401-273 B1	251103	40	box	4-hole flange 25.4 mm 4 x Ø 3.4 mm	73	

Panel Connectors - Solder End



Panel Jack, 4-hole flange

Solder End

Rosenberger No.	Order No.	Sales Unit	Packaging	Remarks	
64 K 401-200 B1	260402	50	standard	4-hole flange 25.4 mm 4 x Ø 3.4 mm	

Adaptors

Adaptors 4.3-10 - 4.3-10



Rosenberger No.	Order No.	Sales Unit	Packaging	Remarks	
64 K 101-K00 B1	265365	1	standard	4.3-10 female - female	
64 S 101-K00 B1	272633	1	standard	4.3-10 male screw type - female	
64 S 101-S00 N1	272635	1	standard	4.3-10 male - male screw type	

Adaptors

Adaptors 4.3-10 - 7-16



Rosenberger No.	Order No.	Sales Unit	Packaging	Remarks	
60 K 164-S00 N1	256038	1	standard	7-16 female - 4.3-10 male screw type	
60 K 164-S60 N1	272629	1	standard	7-16 female - 4.3-10 male quick-lock type	
60 S 164-S00 N1	251967	1	standard	7-16 male - 4.3-10 male screw type	
60 S 164-K00 N1	251111	1	standard	7-16 male - 4.3-10 female	

Adaptors 4.3-10 - SMA

Rosenberger No.	Order No.	Sales Unit	Packaging	Remarks	
32 K 164-S00 N1	259821	1	standard	SMA female - 4.3-10 male screw type	
32 S 164-K00 N1	259820	1	standard	SMA male - 4.3-10 female	

4.3-10

Adaptors 4.3-10 - N 50 Ω

Rosenberger No.	Order No.	Sales Unit	Packaging	Remarks	
53 K 164-S00 N1	256044	1	standard	N female - 4.3-10 male screw type	
53 S 164-K00 N1	255910	1	standard	N male - 4.3-10 female	
53 S 164-S00 N1	255912	1	standard	N male - 4.3-10 male screw type	

Special Tools

Torque Wrench

Rosenberger No.	Order No.	Sales Unit	Packaging	Remarks	
64 W 021-001	285127	1	standard	4.3-10 torque 5 Nm flat 22 mm	

4.1-9.5

Interface Dimensions 4.1-9.5

Code 65

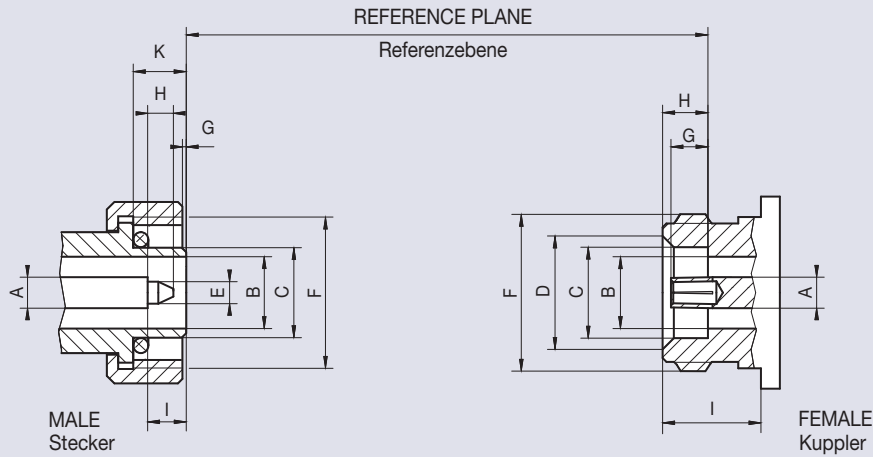

	Male Stecker		Female Kuppler	
	min.	max.	min.	max.
A	Ø 4.13 nom.		Ø 4.13 nom.	
B	Ø 9.40	Ø 9.60	Ø 9.40	Ø 9.60
C	Ø 11.84	Ø 12.02	Ø 12.03	Ø 12.21
D	-	-	Ø 14.90	Ø 15.00
E	Ø 2.855	Ø 2.945	-	-
F	M 20 x 1		M 20 x 1	
G	0.00	1.00	4.73	5.03
H	2.00	4.00	5.80	6.20
I	5.05	5.35	8.00	-
K	1)		-	-

Dimensions in mm

¹⁾ Dimension to meet electrical and mechanical requirements

4.1-9.5 coaxial connectors are robust, weatherproof screw-on connectors with smaller dimensions than 7-16.

4.1-9.5-Koaxial-Steckverbinder sind robuste, witterungsbeständige Schraubsteckverbinder mit kleineren Abmessungen als 7-16-Steckverbinder.

Features

- ▶ Interface according to IEC 60169-11, DIN 47231
- ▶ Frequency range DC to 14 GHz
- ▶ Return loss (cable connector straight) ≥ 23 dB @ 4 GHz
- ▶ Impedance 50 Ω
- ▶ Screw-on coupling

Product Range

- ▶ Cable connectors
- ▶ Panel connectors
- ▶ Adaptors

Technical Data 4.1-9.5

Code 65

Applicable standards Anwendbare Normen	
Interface according to Interface gemäß	IEC 60169-11, DIN 47231
Electrical data Elektrische Daten	
Impedance Wellenwiderstand	50 Ω
Frequency range Frequenzbereich	DC to 14 GHz
Return loss (cable connector straight) Rückflusdämpfung (Kabelsteckverbinder gerade)	≥ 30 dB @ DC to 0.5 GHz ≥ 23 dB @ 0.5 GHz to 4 GHz ≥ 20 dB @ 4 GHz to 10 GHz
Insertion loss Dämpfung	≤ 0.05 x √f (GHz) dB
Insulation resistance Isolationswiderstand	≥ 5 GΩ
Center contact resistance Übergangswiderstand Innenleiter	≤ 1 mΩ
Outer contact resistance Übergangswiderstand Außenleiter	≤ 0.1 mΩ
Working voltage Betriebsspannung	500 V rms
Power handling Leistungsbelastbarkeit	450 W @ 2 GHz / 90 °C
RF leakage - Interface Schirmdämpfung	≥ 114 dB @ DC to 1 GHz
Intermodulation 3rd order Intermodulation 3. Ordnung	≤ -160 dBc (2 x 43 dBm)
Mechanical data Mechanische Daten	
Mating cycles Steckzyklen	≥ 500
Coupling nut retention Überwurfmutter Haltekraft	≥ 500 N
Center contact captivation Innenleiter Haltekraft	axial: ≥ 80 N
Coupling test torque Prüfdrehmoment	≤ 15 Nm
Coupling torque recommended Drehmoment empfohlen	10 Nm
Pitch Packungsdichte	≥ 25.4 mm
Environmental data Umweltdaten	
Temperature range Temperaturbereich	-55 °C to +155 °C
Thermal shock Temperaturzyklen	IEC 60169-1, Sub-clause 16.4 (-55 °C / +155 °C)
Climatic category Klimakategorie	IEC 60068-2-1 55/155/56
Climatic sequence Klimasequenz	IEC 60169-1, Sub-clause 16.2, 55/155/56
Degree of protection (mated pair) Schutzgrad (gekoppeltes Paar)	IEC 60529, IP 68
Corrosion resistance Korrosionsbeständigkeit	IEC 60169-1, Sub-clause 16.7
Vibration Vibration	IEC 60169-1, Sub-clause 15.2.2
Max. soldering temperature (PCB connectors) Max. Löttemperatur (Leiterplattensteckverbinder)	IEC 61760-1, +260 °C for 10 sec.
Materials Materialien	
Spring loaded contact parts Federnde Kontaktteile	CuBe / CuSn, Ag plating
Center contact Innenleiter	CuZn, Ag plating
Outer contact Außenleiter	CuZn, Ag / white bronze plating
Crimping ferrule Crimphülse	Cu, white bronze plating
Dielectric Dielektrikum	PP / PS / PTFE
Gasket Dichtung	Rubber

Rosenberger connectors generally fulfill the indicated technical data. Individual values of connectors may deviate depending upon application, design, type of cable, assembly method and workmanship. Data sheets for particular products can be downloaded on our website or can be provided on request from your Rosenberger sales partner.

Rosenberger-Steckverbinder erfüllen grundsätzlich die hier angegebenen technischen Daten. Je nach Anwendung, Bauart, Kabeltyp, Montageart und -ausführung können einzelne Werte der Steckverbinder hiervon abweichen. Datenblätter zu einzelnen Produkten können Sie von unserer Website herunterladen oder auf Anfrage von Ihrem Rosenberger-Ansprechpartner erhalten.

Cable Connectors - Semi-Rigid Cables

Panel Jack, 4-hole flange

Semi-Rigid Cables

Rosenberger No.	Order No.	Sales Unit	Packaging	Remarks	Cable Group
65 K 401-272 N1	273616	40	box	4-hole flange 25.4 mm 4 x Ø 3.4 mm	72



Panel Connectors - Coaxial End

Panel Jack, 4-hole flange

Coaxial End

Rosenberger No.	Order No.	Sales Unit	Packaging	Remarks
65 K 401-500 N1	227450	40	box	4-hole flange 25.4 mm 4 x Ø 3.4 mm



Adaptors

Adaptors 4.1-9.5 - 7-16

Rosenberger No.	Order No.	Sales Unit	Packaging	Remarks	
60 S 165-SIM N1	247770	1	standard	7-16 male - 4.1-9.5 male	
60 S 165-KIM N1	247771	1	standard	7-16 male - 4.1-9.5 female	

Adaptors 4.1-9.5 - N 50 Ω

Rosenberger No.	Order No.	Sales Unit	Packaging	Remarks	
65 S 153-KIM N1	264916	1	standard	4.1-9.5 male - N female	
53 S 165-SIM N1	266929	1	standard	N male - 4.1-9.5 male	

Accessories

Protective Cap

Rosenberger No.	Order No.	Sales Unit	Packaging	Remarks	
65 Z 001-000 N	260112	50	standard	male	

Special Tools

Torque Wrench

Rosenberger No.	Order No.	Sales Unit	Packaging	Remarks	
64 W 021-002	285128	1	standard	4.1-9.5 torque 10 Nm flat 22 mm	

7-16



7-16 coaxial connectors – high-quality coaxial connectors with low attenuation and intermodulation for frequencies up to 8.3 GHz – are suitable for medium to high power transmission in outdoor applications due to their high mechanical stability and best possible weather resistance.

7-16-Koaxial-Steckverbinder - hochwertige, dämpfungs- und intermodulationsarme Koaxialsteckverbinder für Frequenzen bis 8,3 GHz - eignen sich aufgrund hoher mechanischer Stabilität und hervorragender Witterungsbeständigkeit besonders für Anwendungen im Outdoor-Bereich, z.B. für die Übertragung mittlerer bis hoher Leistungen in der Nachrichtentechnik.

7-16

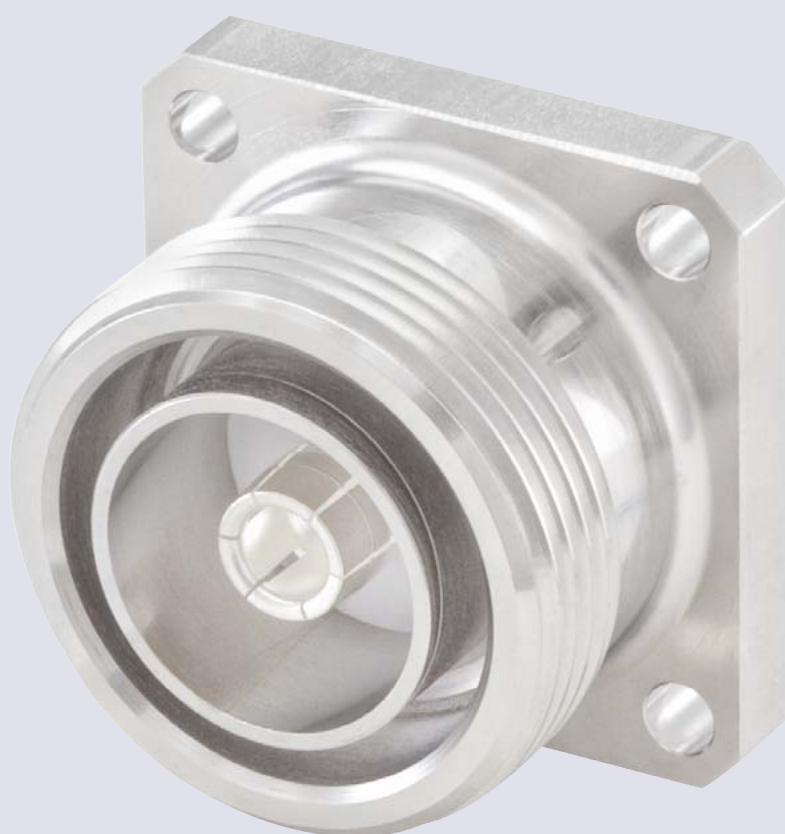

Interface Dimensions 7-16

Code 60

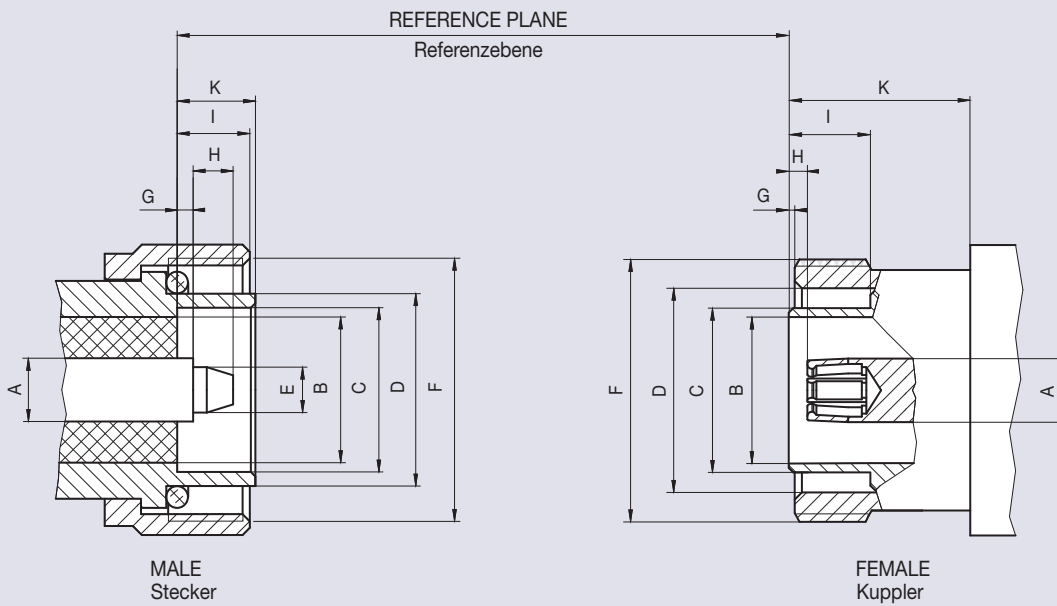

	Male Stecker		Female Kuppler	
	min.	max.	min.	max.
A	Ø 7.00 nom.		Ø 7.00 nom.	
B	Ø 15.85	Ø 16.25	Ø 15.85	Ø 16.25
C	Ø 18.03	Ø 18.21	Ø 17.84	Ø 18.02
D	Ø 20.60	Ø 21.40	Ø 22.10	Ø 22.90
E	Ø 4.96	Ø 5.04	-	-
F	M 29 x 1.5		M 29 x 1.5	
G	1.47	1.77	0.50	0.70
H	-	4.50	1.77	2.07
I	7.00	9.00	8.10	-
K	7.00	8.00	10.00	-

Dimensions in mm

¹⁾ Resilient, dimension to meet electrical and mechanical requirements

Features

- ▶ Interface according to IEC 61169-4, EN 122190, DIN 47233
- ▶ Frequency range DC to 7.5 GHz
- ▶ Return loss (cable connector straight) ≥ 21 dB @ 4 GHz
- ▶ Impedance 50 Ω
- ▶ Screw-on coupling

Product Range

- ▶ Cable connectors
- ▶ Panel connectors
- ▶ Adaptors
- ▶ Terminations

Technical Data 7-16

Code 60

Applicable standards Anwendbare Normen	
Interface according to Interface gemäß	IEC 61169-4, EN 122190, DIN 47223
Electrical data Elektrische Daten	
Impedance Wellenwiderstand	50 Ω
Frequency range Frequenzbereich	DC to 7.5 GHz
Return loss (cable connector straight) Rückflusdämpfung (Kabelsteckverbinder gerade)	≥ 32 dB @ DC to 0.5 GHz ≥ 21 dB @ 0.5 GHz to 4 GHz ≥ 17 dB @ 4 GHz to 7.5 GHz
Insertion loss Dämpfung	≤ 0.05 x √f (GHz) dB
Insulation resistance Isolationswiderstand	≥ 10 GΩ
Center contact resistance Übergangswiderstand Innenleiter	≤ 0.4 mΩ
Outer contact resistance Übergangswiderstand Außenleiter	≤ 1.5 mΩ
Working voltage Betriebsspannung	500 V rms
Power handling Leistungsbelastbarkeit	1800 W @ 1 GHz 800 W @ 4 GHz
RF leakage - Interface Schirmdämpfung	≥ 128 dB @ DC to 1 GHz
Intermodulation 3rd order Intermodulation 3. Ordnung	≤ -155 dBc (2 x 43 dBm)
Mechanical data Mechanische Daten	
Mating cycles Steckzyklen	≥ 500
Coupling nut retention Überwurfmutter Haltekraft	≥ 1000 N
Center contact captivation Innenleiter Haltekraft	axial: ≥ 200 N radial: ≥ 2 Ncm
Coupling test torque Prüfdrehmoment	≤ 35 Nm
Coupling torque recommended Drehmoment empfohlen	25 Nm to 30 Nm
Pitch Packungsdichte	≥ 32 mm
Environmental data Umweltdaten	
Temperature range Temperaturbereich	-55 °C to +155 °C
Thermal shock Temperaturzyklen	DIN EN 122190, Sub-clause 4.6.7
Damp heat Feuchte Wärme	DIN EN 122190, Sub-clause 4.6.6
Climatic category Klimakategorie	DIN EN 122190, Sub-clause 4.6.5 55/155/56
Degree of protection (mated pair) Schutzgrad (gekoppeltes Paar)	IEC 60529, IP 68
Corrosion resistance Korrosionsbeständigkeit	DIN EN 122190, Sub-clause 4.6.10
Vibration Vibration	DIN EN 122190, Sub-clause 4.6.3
Max. soldering temperature (PCB connectors) Max. Löttemperatur (Leiterplattensteckverbinder)	IEC 61760-1, +260 °C for 10 sec.
Materials Materialien	
Spring loaded contact parts Federnde Kontaktteile	CuBe / CuSn, Ag plating
Center contact Innenleiter	CuZn, Ag plating
Outer contact Außenleiter	CuZn, Ag / white bronze plating
Crimping ferrule Crimphülse	Cu, white bronze plating
Dielectric Dielektrikum	PP / PS / PTFE
Gasket Dichtung	Rubber



Rosenberger connectors generally fulfill the indicated technical data. Individual values of connectors may deviate depending upon application, design, type of cable, assembly method and workmanship. Data sheets for particular products can be downloaded on our website or can be provided on request from your Rosenberger sales partner.

Rosenberger-Steckverbinder erfüllen grundsätzlich die hier angegebenen technischen Daten. Je nach Anwendung, Bauart, Kabeltyp, Montageart und -ausführung können einzelne Werte der Steckverbinder hiervon abweichen. Datenblätter zu einzelnen Produkten können Sie von unserer Website herunterladen oder auf Anfrage von Ihrem Rosenberger-Ansprechpartner erhalten.

Cable Connectors - Semi-Rigid Cables

Straight Plug, solder

Semi-Rigid Cables

Rosenberger No.	Order No.	Sales Unit	Packaging	Remarks	Cable Group	
60 S 131-272 B1	166556	20	box	length 33.1 mm	72	
60 S 137-273 N1	195041	40	box	length 25.2 mm	73	

Panel Jack, 4-hole flange

Semi-Rigid Cables

Rosenberger No.	Order No.	Sales Unit	Packaging	Remarks	Cable Group	
60 K 442-272 N1	261891	20	box	4-hole flange 32 mm 4 x Ø 3.6 mm	72	

Cable Connectors - Flexible Cables

Straight Plug, crimp

Flexible Cables

Rosenberger No.	Order No.	Sales Unit	Packaging	Cable Group	
60 S 131-806 N1	137986	20	box	06	
60 S 131-815 N1	137437	20	box	15	
60 S 131-817 N1	137628	20	box	16, 17	

Right Angle Plug, solder-crimp

Flexible Cables

Rosenberger No.	Order No.	Sales Unit	Packaging	Cable Group	
60 S 23B-315 N1	240810	25	standard	15	
60 S 23B-317 N1	240809	25	standard	16, 17	

Straight Jack, crimp

Flexible Cables

Rosenberger No.	Order No.	Sales Unit	Packaging	Cable Group	
60 K 131-815 N1	137999	25	box	15	
60 K 131-817 N1	137848	25	box	16, 17	

Panel Jack, crimp, 4-hole flange

Flexible Cables

Rosenberger No.	Order No.	Sales Unit	Packaging	Remarks	Cable Group	
60 K 431-815 N1	141200	20	box	4-hole flange 32 mm 4 x M3	15	
60 K 431-817 N1	143347	20	box	4-hole flange 32 mm 4 x M3	17	

Panel Connectors - Threaded End

Panel Jack, 4-hole flange

Threaded End

Rosenberger No.	Order No.	Sales Unit	Packaging	Remarks	
60 K 47U-900 N1	212435	10	box	4-hole flange 32 mm 4 x Ø 3.6 mm center contact thread M3 length 4.0 mm	

Adaptors

Adaptors 7-16 - 7-16

Rosenberger No.	Order No.	Sales Unit	Packaging	Remarks	
60 S 101-SIM N1	277157	1	standard	7-16 male - male	
60 S 101-KIM N1	238467	1	standard	7-16 male - female	
60 K 101-KIM N1	238485	1	standard	7-16 female - female	
60 K 501-K50 N1	141127	1	standard	7-16 female - female round flange	
60 S 231-K00 N1	147266	1	standard	7-16 male - female right angle	

Adaptors 7-16 - QN

Rosenberger No.	Order No.	Sales Unit	Packaging	Remarks	
153Q K 160-S00 N5	204686	1	standard	QN female - 7-16 male	

Adaptors 7-16 - 4.3-10

Rosenberger No.	Order No.	Sales Unit	Packaging	Remarks	
60 K 164-S00 N1	256038	1	standard	7-16 female - 4.3-10 male screw type	
60 K 164-S60 N1	272629	1	standard	7-16 female - 4.3-10 male quick-lock type	
60 S 164-S00 N1	251967	1	standard	7-16 male - 4.3-10 male screw type	
60 S 164-K00 N1	251111	1	standard	7-16 male - 4.3-10 female	



Adaptors 7-16 - 4.-9.5

Rosenberger No.	Order No.	Sales Unit	Packaging	Remarks	
60 S 165-SIM N1	247770	1	standard	7-16 male - 4.1-9.5 male	
60 S 165-KIM N1	247771	1	standard	7-16 male - 4.1-9.5 female	

Adaptors 7-16 - N 50 Ω

Rosenberger No.	Order No.	Sales Unit	Packaging	Remarks	
60 S 153-KIM N1	238486	1	standard	7-16 male - N female	
53 S 160-SIM N1	253033	1	standard	N male - 7-16 male	
53 S 160-KIM N1	238488	1	standard	N male - 7-16 female	
53 K 160-KIM N1	263127	1	standard	N female - 7-16 female	



Adaptors 7-16 - QMA

Rosenberger No.	Order No.	Sales Unit	Packaging	Remarks	
28 S 160-S00 N5	160223	1	standard	QMA male - 7-16 male	
28 K 160-S00 N5	159005	1	standard	QMA female - 7-16 male	

Adaptors 7-16 - RPC-N 50 Ω



Rosenberger No.	Order No.	Sales Unit	Packaging	Remarks	Return Loss	
05 S 160-S50 D3	103182	1	standard	RPC-N 50 Ω male - 7-16 male calibration adaptor	≥ 36 dB @ DC to 4 GHz ≥ 33 dB @ 4 GHz to 8 GHz	
05 S 160-K50 D3	105606	1	standard	RPC-N 50 Ω male - 7-16 female calibration adaptor	≥ 36 dB @ DC to 4 GHz ≥ 33 dB @ 4 GHz to 8 GHz	
05 K 160-S50 D3	101163	1	standard	RPC-N 50 Ω female - 7-16 male calibration adaptor	≥ 36 dB @ DC to 4 GHz ≥ 33 dB @ 4 GHz to 8 GHz	
05 K 160-K50 D3	100708	1	standard	RPC-N 50 Ω female - 7-16 female calibration adaptor	≥ 36 dB @ DC to 4 GHz ≥ 33 dB @ 4 GHz to 8 GHz	

Adaptors 7-16 - SMA



Rosenberger No.	Order No.	Sales Unit	Packaging	Remarks	
32 S 160-S00 N5	160222	1	standard	SMA male - 7-16 male	
32 K 160-S00 N5	157551	1	standard	SMA female - 7-16 male	

Terminations

Termination Plug

Rosenberger No.	Order No.	Sales Unit	Packaging	Remarks	Return Loss	
60 S 17R-001 N1	143025	1	standard	1 Watt Frequency: DC to 8 GHz	≥ 34.1 dB @ DC to 2 GHz ≥ 26 dB @ 2 GHz to 8 GHz	
60 S 17R-C01 D3	105519	1	standard	1 Watt Frequency: DC to 8 GHz for calibration kit	≥ 40 dB @ DC to 4 GHz ≥ 36.6 dB @ 4 GHz to 8 GHz	
60 S 15R-002 N1	147009	1	standard	2 Watt Frequency: DC to 3 GHz	≥ 34.1 dB @ DC to 2 GHz ≥ 26 dB @ 2 GHz to 3 GHz	

Termination Jack

Rosenberger No.	Order No.	Sales Unit	Packaging	Remarks	Return Loss	
60 K 17R-001 N1	143026	1	standard	1 Watt Frequency: DC to 8 GHz	≥ 34.1 dB @ DC to 2 GHz ≥ 26 dB @ 2 GHz to 8 GHz	
60 K 17R-C01 D3	103099	1	standard	1 Watt Frequency: DC to 8 GHz for calibration kit	≥ 40 dB @ DC to 4 GHz ≥ 36.6 dB @ 4 GHz to 8 GHz	
60 K 15R-002 N1	148395	1	standard	2 Watt Frequency: DC to 3 GHz	≥ 34.1 dB @ DC to 2 GHz ≥ 26 dB @ 2 GHz to 3 GHz	

Special Tools

Torque Wrench

Rosenberger No.	Order No.	Sales Unit	Packaging	Remarks	
60 W 000-002	205478	1	standard	7-16 torque 25 Nm flat 32 mm	

Reverse Polarity Connectors (SMA, BNC, TNC)



“Reverse Polarity” coaxial connectors are non-standardized versions of standard connector series: interfaces are similar to the standards, center contacts and dielectricum are reversed: male connectors would have female center contacts, female connectors would have male center contacts. Reverse polarity connectors are used for connecting W-LAN components.

Rosenberger provides SMA, BNC and TNC reverse polarity connectors.

„Reverse Polarity“-Koaxial-Steckverbinder sind nicht genormte Versionen von Standard-Steckverbinder-Serien: Innenleiter und Dielektrika sind invers bestückt, d.h. Stecker haben einen Kuppler-Innenleiter und Kuppler einen Stecker-Innenleiter. Reverse Polarity Steckverbinder werden eingesetzt zum Verbinden von W-LAN-Komponenten.

Rosenberger bietet Reverse Polarity-Steckverbinder in den Serien SMA, BNC und TNC.

SMA Reverse
BNC Reverse 50 Ω
TNC Reverse 50 Ω

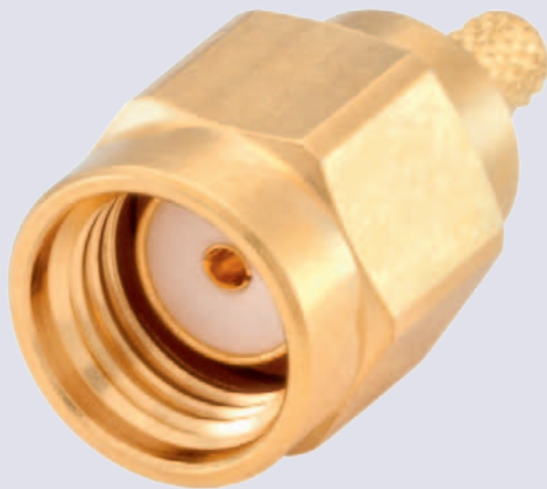

SMA Reverse

Interface Dimensions SMA Reverse

Code 32R

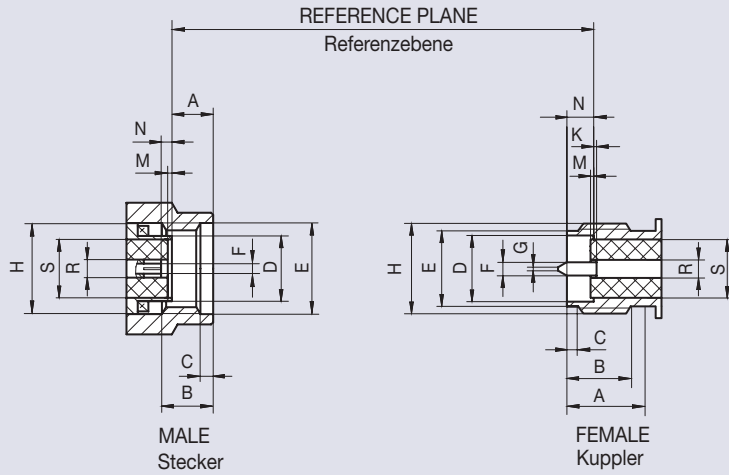

	Male Stecker		Female Kuppler	
	min.	max.	min.	max.
A	–	3.43	5.54	–
B	2.54	–	4.32	–
C	0.38	1.14	0.38	1.14
D	–	Ø 4.59	Ø 4.60	Ø 4.67
E	Ø 6.35	–	Ø 5.28	Ø 5.49
F	1)		Ø 0.902	Ø 0.94
G	–	–	–	Ø 0.38
H	1/4-36 UNS-2B		1/4-36 UNS-2A	
K	–	–	0.00	0.25
M	–	0.00	–	0.00
N	0.00	0.25	1.88	1.98
R	Ø 1.245	Ø 1.295	Ø 1.245	Ø 1.295
S	–	Ø 4.178	–	Ø 4.178

Dimensions in mm

¹⁾ Resilient, dimension to meet electrical and mechanical requirements

Features

- ▶ Interface according to Rosenberger Reverse SMA, FCC Standard
- ▶ Frequency range DC to 18 GHz
- ▶ Return loss (cable connector straight) ≥ 26 dB (typ.)
- ▶ Impedance 50 Ω
- ▶ Screw-on coupling

Product Range

- ▶ Cable connectors
- ▶ PCB connectors
- ▶ Adaptors

Technical Data SMA Reverse

Code 32R

Applicable standards Anwendbare Normen	
Interface according to Interface gemäß	Rosenberger SMA Reverse compliant with FCC standard (part 15, section 15.203) derived from IEC 60169-15, MIL-PRF-39012, EN 122110
Electrical data Elektrische Daten	
Impedance Wellenwiderstand	50 Ω
Frequency range Frequenzbereich	DC to 18 GHz
Return loss (cable connector straight) Rückflussdämpfung (Kabelsteckverbinder gerade)	≥ 26 dB (typ.)
Insertion loss Dämpfung	≤ 0.1 × √f (GHz) dB
Insulation resistance Isolationswiderstand	≥ 5 GΩ
Center contact resistance Übergangswiderstand Innenleiter	≤ 3 mΩ
Outer contact resistance Übergangswiderstand Außenleiter	≤ 2 mΩ
Test voltage Prüfspannung	1000 V rms
Working voltage Betriebsspannung	480 V rms
Power handling Leistungsbelastbarkeit	200 W @ 2 GHz
RF leakage - Interface Schirmdämpfung	≥ 100 dB @ DC to 1 GHz
Mechanical data Mechanische Daten	
Mating cycles Steckzyklen	≥ 100
Coupling nut retention Überwurfmutter Haltekraft	≥ 180 N
Center contact captivation Innenleiter Haltekraft	axial: ≥ 20 N
Coupling test torque Prüfdrehmoment	≤ 0.6 Nm
Coupling torque recommended Drehmoment empfohlen	0.5 Nm
Environmental data Umweltdaten	
Temperature range Temperaturbereich	-65 °C to +165 °C
Thermal shock Temperaturzyklen	MIL-STD-202, Method 107, Condition B
Corrosion resistance Korrosionsbeständigkeit	MIL-STD-202, Method 101, Condition B
Moisture resistance Feuchtigkeitsbeständigkeit	MIL-STD-202, Method 106
Vibration Vibration	MIL-STD-202, Method 204, Condition B
Shock Schock	MIL-STD-202, Method 213, Condition I
Max. soldering temperature (PCB connectors) Max. Löttemperatur (Leiterplattensteckverbinder)	IEC 61760-1, +260 °C for 10 sec.
Materials Materialien	
Spring loaded contact parts Federnde Kontaktteile	CuBe, Au plating
Center contact Innenleiter	CuZn, Au plating
Outer contact Außenleiter	CuZn, Au plating
Body Gehäuse	CuZn, Au plating
Coupling nut Überwurfmutter	CuZn, Au plating
Crimping ferrule Crimphülse	Cu, Au plating
Dielectric Dielektrikum	PTFE
Gasket Dichtung	Silicone

Rosenberger connectors generally fulfill the indicated technical data. Individual values of connectors may deviate depending upon application, design, type of cable, assembly method and workmanship. Data sheets for particular products can be downloaded on our website or can be provided on request from your Rosenberger sales partner.

Rosenberger-Steckverbinder erfüllen grundsätzlich die hier angegebenen technischen Daten. Je nach Anwendung, Bauart, Kabeltyp, Montageart und -ausführung können einzelne Werte der Steckverbinder hiervon abweichen. Datenblätter zu einzelnen Produkten können Sie von unserer Website herunterladen oder auf Anfrage von Ihrem Rosenberger-Ansprechpartner erhalten.

Cable Connectors - Flexible Cables

Straight Plug, solder-crimp

Flexible Cables

Rosenberger No.	Order No.	Sales Unit	Packaging	Cable Group	
32R S 147-302 L5	147305	50	standard	02	

Right Angle Plug, solder-crimp

Flexible Cables

Rosenberger No.	Order No.	Sales Unit	Packaging	Cable Group	
32R S 247-302 L5	155778	25	standard	02	

Straight Panel Jack, solder-crimp, hexagonal flange

Flexible Cables

Rosenberger No.	Order No.	Sales Unit	Packaging	Remarks	Cable Group	
32R K 647-302 L5	147308	25	standard	hexagonal flange rear mount	02	

PCB Connectors - Solder Pin



Right Angle Jack

Solder Pin

Rosenberger No.	Order No.	Sales Unit	Packaging	
32R K 241-400 L5	147310	50	blister	

Adaptors

Adaptors SMA Reverse - SMA

Rosenberger No.	Order No.	Sales Unit	Packaging	Remarks	
32R S 132-K00 L5	159287	1	standard	SMA Reverse male - SMA Standard female	
32R K 132-S00 L5	180528	1	standard	SMA Reverse female - SMA Standard male	

BNC Reverse 50 Ω

Interface Dimensions BNC Reverse 50 Ω

Code 51R

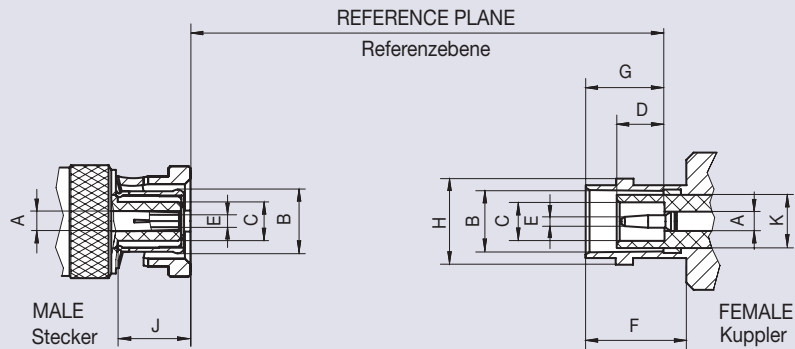

	Male Stecker		Female Kuppler	
	min.	max.	min.	max.
A	Ø 2.06	Ø 2.21	Ø 2.06	Ø 2.21
B	1)		Ø 8.10	Ø 8.15
C	–	Ø 4.72	Ø 4.83	–
D	–	–	4.78	5.28
E	1)		Ø 1.32	Ø 1.37
F	–	–	10.52	–
G	–	–	8.31	8.51
H	–	–	Ø 10.97	Ø 11.07
J	5.28	5.79	–	–
K	–	–	Ø 7.00 nom.	

Dimensions in mm

¹⁾ Resilient, dimension to meet electrical and mechanical requirements

Features

- ▶ Interface according to Rosenberger Reverse BNC, FCC Standard
- ▶ Frequency range DC to 10 GHz (max.), DC to 4 GHz (opt.)
- ▶ Return loss (cable connector straight) ≥ 20 dB (typ.)
- ▶ Impedance 50 Ω
- ▶ Bayonet coupling

Product Range

Connectors are available on request

Technical Data BNC Reverse 50 Ω

Code 51R

Applicable standards Anwendbare Normen	
Interface according to Interface gemäß	Rosenberger BNC Reverse compliant with FCC standard (part 15, section 15.203) derived from IEC 61169-8, MIL-PRF-39012, CECC 22120
Electrical data Elektrische Daten	
Impedance Wellenwiderstand	50 Ω
Frequency range Frequenzbereich	DC to 10 GHz (max.) DC to 4 GHz (opt.)
Return loss (cable connector straight) Rückflusdämpfung (Kabelsteckverbinder gerade)	≥ 20 dB (typ.)
Insertion loss Dämpfung	≤ 0.1 × √f (GHz) dB
Insulation resistance Isolationswiderstand	≥ 5 GΩ
Center contact resistance Übergangswiderstand Innenleiter	≤ 1.5 mΩ
Outer contact resistance Übergangswiderstand Außenleiter	≤ 1 mΩ
Test voltage Prüfspannung	1500 V rms
Working voltage Betriebsspannung	400 V rms
Power handling Leistungsbelastbarkeit	80 W @ 2 GHz
Mechanical data Mechanische Daten	
Mating cycles Steckzyklen	≥ 500
Center contact captivation Innenleiter Haltekraft	axial: ≥ 15 N
Environmental data Umweltdaten	
Temperature range Temperaturbereich	-65 °C to +165 °C
Thermal shock Temperaturzyklen	MIL-STD-202, Method 107, Condition B
Corrosion resistance Korrosionsbeständigkeit	MIL-STD-202, Method 101, Condition B
Moisture resistance Feuchtigkeitsbeständigkeit	MIL-STD-202, Method 106
Vibration Vibration	MIL-STD-202, Method 204, Condition B
Shock Schock	MIL-STD-202, Method 213, Condition G
Max. soldering temperature (PCB connectors) Max. Löttemperatur (Leiterplattensteckverbinder)	IEC 61760-1, +260 °C for 10 sec.
Materials Materialien	
Spring loaded contact parts Federnde Kontaktteile	CuBe / CuSn, Au plating
Center contact Innenleiter	CuZn, Au plating
Outer contact Außenleiter	CuZn, white bronze plating
Crimping ferrule Crimphülse	Cu, white bronze plating
Dielectric Dielektrikum	PTFE
Gasket Dichtung	Silicone

Rosenberger connectors generally fulfill the indicated technical data. Individual values of connectors may deviate depending upon application, design, type of cable, assembly method and workmanship. Data sheets for particular products can be downloaded on our website or can be provided on request from your Rosenberger sales partner.

Rosenberger-Steckverbinder erfüllen grundsätzlich die hier angegebenen technischen Daten. Je nach Anwendung, Bauart, Kabeltyp, Montageart und -ausführung können einzelne Werte der Steckverbinder hiervon abweichen. Datenblätter zu einzelnen Produkten können Sie von unserer Website herunterladen oder auf Anfrage von Ihrem Rosenberger-Ansprechpartner erhalten.

TNC Reverse 50 Ω

Interface Dimensions TNC Reverse 50 Ω

Code 56R

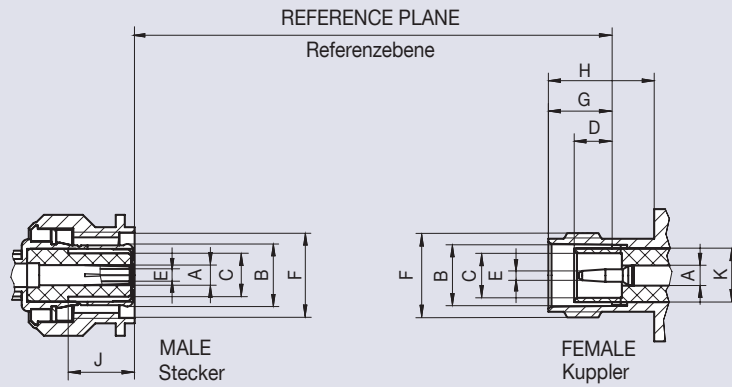

	Male Stecker		Female Kuppler	
	min.	max.	min.	max.
A	Ø 2.06	Ø 2.21	Ø 2.06	Ø 2.21
B	1)		Ø 8.10	Ø 8.15
C	–	Ø 4.72	Ø 4.83	–
D	–	–	4.78	5.28
E	1)		Ø 1.32	Ø 1.37
F	7/16-28 UNEF-2B		7/16-28 UNEF-2A	
G	–	–	8.31	8.51
H	–	–	Ø 10.52	–
J	5.28	5.79	–	–
K	–	–	Ø 7.00 nom.	

Dimensions in mm

¹⁾ Resilient, dimension to meet electrical and mechanical requirements

Features

- ▶ Interface according to Rosenberger Reverse TNC, FCC Standard
- ▶ Frequency range DC to 10 GHz (max.), DC to 4 GHz (opt.)
- ▶ Return loss (cable connector straight) ≥ 20 dB (typ.)
- ▶ Impedance 50 Ω
- ▶ Screw-on coupling

Product Range

Connectors are available on request

Technical Data TNC Reverse 50 Ω

Code 56R

Applicable standards Anwendbare Normen	
Interface according to Interface gemäß	Rosenberger TNC Reverse compliant with FCC standard (part 15, section 15.203) derived from IEC 60169-17, MIL-PRF-39012, DIN EN 122200
Electrical data Elektrische Daten	
Impedance Wellenwiderstand	50 Ω
Frequency range Frequenzbereich	DC to 10 GHz (max.) DC to 4 GHz (opt.)
Return loss (cable connector straight) Rückflussdämpfung (Kabelsteckverbinder gerade)	≥ 20 dB (typ.)
Insertion loss Dämpfung	≤ 0.1 × √f (GHz) dB
Insulation resistance Isolationswiderstand	≥ 5 GΩ
Center contact resistance Übergangswiderstand Innenleiter	≤ 1.5 mΩ
Outer contact resistance Übergangswiderstand Außenleiter	≤ 1 mΩ
Test voltage Prüfspannung	1500 V rms
Working voltage Betriebsspannung	500 V rms
Power handling Leistungsbelastbarkeit	80 W @ 2 GHz
Mechanical data Mechanische Daten	
Mating cycles Steckzyklen	≥ 500
Center contact captivation Innenleiter Haltekraft	axial: ≥ 15 N
Coupling torque recommended Drehmoment empfohlen	0.46 Nm to 0.69 Nm
Environmental data Umweltdaten	
Temperature range Temperaturbereich	-65 °C to +165 °C
Thermal shock Temperaturzyklen	MIL-STD-202, Method 107, Condition B
Corrosion resistance Korrosionsbeständigkeit	MIL-STD-202, Method 101, Condition B
Moisture resistance Feuchtigkeitsbeständigkeit	MIL-STD-202, Method 106
Vibration Vibration	MIL-STD-202, Method 204, Condition B
Shock Schock	MIL-STD-202, Method 213, Condition G
Max. soldering temperature (PCB connectors) Max. Löttemperatur (Leiterplattensteckverbinder)	IEC 61760-1, +260 °C for 10 sec.
Materials Materialien	
Spring loaded contact parts Federnde Kontaktteile	CuBe / CuSn, Au plating
Center contact Innenleiter	CuZn, Au plating
Outer contact Außenleiter	CuZn, white bronze plating
Crimping ferrule Crimphülse	Cu, white bronze plating
Dielectric Dielektrikum	PTFE
Gasket Dichtung	Silicone

Rosenberger connectors generally fulfill the indicated technical data. Individual values of connectors may deviate depending upon application, design, type of cable, assembly method and workmanship. Data sheets for particular products can be downloaded on our website or can be provided on request from your Rosenberger sales partner.

Rosenberger-Steckverbinder erfüllen grundsätzlich die hier angegebenen technischen Daten. Je nach Anwendung, Bauart, Kabeltyp, Montageart und -ausführung können einzelne Werte der Steckverbinder hiervon abweichen. Datenblätter zu einzelnen Produkten können Sie von unserer Website herunterladen oder auf Anfrage von Ihrem Rosenberger-Ansprechpartner erhalten.

Micro-RF



Micro-RF components can be used up to 6 GHz in various wireless applications, e. g. cellular and cordless phones, Bluetooth and wireless LAN applications, PDAs (Personal Digital Assistants) or wireless data collecting systems. Rosenberger provides Micro-RF components such as Micro-RF test switches, PCB connectors, cable assemblies, adapters.

Mikro-HF-Komponenten sind für verschiedene Wireless-Anwendungen bis 6 GHz geeignet, z. B. Mobil- und Schnurlostelefone, Bluetooth-Anwendungen, Wireless LAN, PDAs (Personal Digital Assistants) oder Datenerfassungssysteme. Rosenberger bietet Mikro-HF-Komponenten wie Mikro-HF-Testschalter, -PCB-Steckverbinder, Kabel-Assemblies, Adapter.

Micro-RF Switches
Micro-RF Cable Assemblies
Micro-RF Adaptors



Technical Data Micro-RF Switches

Code 15

Applicable standards Anwendbare Normen	
Interface according to Interface gemäß	Rosenberger Micro-RF
Electrical data Elektrische Daten	
Impedance Wellenwiderstand	50 Ω
Frequency range Frequenzbereich	DC to 6 GHz
Return loss (cable connector straight) Rückflusdämpfung (Kabelsteckverbinder gerade)	≥ 26 dB @ DC to 2 GHz ≥ 22 dB @ 2 GHz to 4 GHz ≥ 16 dB @ 4 GHz to 6 GHz
Insertion loss Dämpfung	≤ 0.05 x √f (GHz) dB
Insulation resistance Isolationswiderstand	≥ 0.5 GΩ
Center contact resistance Übergangswiderstand Innenleiter	≤ 100 mΩ
Outer contact resistance Übergangswiderstand Außenleiter	≤ 50 mΩ
Working voltage Betriebsspannung	4 V rms
Mechanical data Mechanische Daten	
Mating cycles Steckzyklen	≥ 100
Engagement force Steckkraft	≤ 4 N
Disengagement force Ziehkraft	≥ 2 N
Axial misalignment Axialer Toleranzausgleich	± 0.3 mm
Radial misalignment Radialer Toleranzausgleich	4°
Environmental data Umweltdaten	
Temperature range Temperaturbereich	-40 °C to +90 °C
Max. soldering temperature (PCB connectors) Max. Löttemperatur (Leiterplattensteckverbinder)	IEC 61760-1, +260 °C for 10 sec.
Materials Materialien	
Body Gehäuse	Zn diecasting, Au plating
Switching spring Schaltfeder	CuBe, Au plating
Stationary spring Feder	CuZn, Au plating
Spring carrier Federstütze	PEEK

Rosenberger connectors generally fulfill the indicated technical data. Individual values of connectors may deviate depending upon application, design, type of cable, assembly method and workmanship. Data sheets for particular products can be downloaded on our website or can be provided on request from your Rosenberger sales partner.

Rosenberger-Steckverbinder erfüllen grundsätzlich die hier angegebenen technischen Daten. Je nach Anwendung, Bauart, Kabeltyp, Montageart und -ausführung können einzelne Werte der Steckverbinder hiervon abweichen. Datenblätter zu einzelnen Produkten können Sie von unserer Website herunterladen oder auf Anfrage von Ihrem Rosenberger-Ansprechpartner erhalten.

Technical Data Micro-RF Components

Code 15

Applicable standards Anwendbare Normen	
Interface according to Interface gemäß	Rosenberger Micro-RF
Interface intermateable with Interface steckkompatibel mit	Micro-RF switch 15K101-40M
Electrical data Elektrische Daten	
Impedance Wellenwiderstand	50 Ω
Frequency range Frequenzbereich	DC to 6 GHz
Return loss (Snap-on adaptor) Rückflusdämpfung (Snap-on-Adapter)	≥ 21 dB @ DC to 2 GHz ≥ 17 dB @ 2 GHz to 4 GHz ≥ 14 dB @ 4 GHz to 6 GHz
Return loss (Slide-on adaptor) Rückflusdämpfung (Slide-on-Adapter)	≥ 28 dB @ DC to 2 GHz ≥ 25 dB @ 2 GHz to 4 GHz ≥ 21 dB @ 4 GHz to 6 GHz
Insertion loss Dämpfung	≤ 0.05 x √f (GHz) dB
Insulation resistance Isolationswiderstand	≥ 5 GΩ
Center contact resistance Übergangswiderstand Innenleiter	≤ 50 mΩ
Outer contact resistance Übergangswiderstand Außenleiter	≤ 50 mΩ
Working voltage Betriebsspannung	4 V rms
Mechanical data Mechanische Daten	
Mating cycles Steckzyklen	≥ 10,000 (Snap-on Adaptor) ≥ 200,000 (Slide-on Adaptor)
Engagement force Steckkraft	≤ 4 N
Disengagement force Ziehkraft	≥ 2 N
Axial misalignment Axialer Toleranzausgleich	± 0.7 mm
Radial misalignment Radialer Toleranzausgleich	4°
Environmental data Umweltdaten	
Temperature range Temperaturbereich	-40 °C to +90 °C
Max. soldering temperature (PCB connectors) Max. Löttemperatur (Leiterplattensteckverbinder)	IEC 61760-1, +260 °C for 10 sec.
Materials Materialien	
Center contact Innenleiter	CuBe / CuSn, Au plating
Outer contact Außenleiter	CuBe / CuSn, Au plating
Dielectric Dielektrikum	TPX

Rosenberger connectors generally fulfill the indicated technical data. Individual values of connectors may deviate depending upon application, design, type of cable, assembly method and workmanship. Data sheets for particular products can be downloaded on our website or can be provided on request from your Rosenberger sales partner.

Rosenberger-Steckverbinder erfüllen grundsätzlich die hier angegebenen technischen Daten. Je nach Anwendung, Bauart, Kabeltyp, Montageart und -ausführung können einzelne Werte der Steckverbinder hiervon abweichen. Datenblätter zu einzelnen Produkten können Sie von unserer Website herunterladen oder auf Anfrage von Ihrem Rosenberger-Ansprechpartner erhalten.

PCB Connectors - SMD





Straight Jack, Test Switch

SMD

Rosenberger No.	Order No.	Sales Unit	Packaging	Remarks	
15 K 101-40M E4	183315	2500	tape & reel	1.80 mm x 1.90 mm	
	154760	9000	tape & reel		



Cable Assemblies

Cable Assemblies

Rosenberger No.	Order No.	Sales Unit	Packaging	Remarks	Cable	Connector 1	Connector 2	
L H1-021-300	180216	1	standard	length 300 mm other lengths on request	RTK 013	15 S 209-3H1	32 S 101-3H1	
L H1-099-300	264989	1	standard	length 300 mm other lengths on request	RTK 013	15 S 201-1H1	32 S 101-3H1	
L E3-006-100	216896	1	standard	length 100 mm other lengths on request	RTK 008	15 S 202-1E3	15 S 202-1E3	
L H1-071-300	216897	1	standard	length 300 mm other lengths on request	RTK 013	15 S 202-1H1	15 S 202-1H1	

Adaptors

Adaptors Micro-RF - SMA

Rosenberger No.	Order No.	Sales Unit	Packaging	Remarks	
15 S 132-K04 L5	155284	1	standard	Micro-RF male - SMA female for 15 K 101-40M E4 slide-on Mating cycles \geq 200,000	
15 S 132-K02 L5	161744	1	standard	Micro-RF male - SMA female for 15 K 101-40M E4 snap-on Mating cycles \geq 10,000	
15 S 132-K05 L5	155288	1	standard	Micro-RF male - SMA female for 15 K 101-40M E4 snap-on Mating cycles \geq 10,000	

Cable Clamp, non magnetic

Cable Clamp

Rosenberger No.	Order No.	Sales Unit	Packaging	Remarks	
15 C 102-40M L5-NM	192982	2000	tape & reel	housing according 15 Z 202-1H1 L5-NM (Cable L H1-053-xxx-NM)	

Cable Assemblies, non magnetic

Cable Assemblies according Cable Clamp 15 C 102-40m L5

Rosenberger No.	Order No.	Sales Unit	Packaging	Remarks	Cable	Connector 1	Connector 2	
L H1-053-xxx-NM	228051	25	standard	xxx: please fill in requested length in mm	RTK 013	15 Z 202- 1H1L5-NM	15 Z 202- 1H1L5-NM	

Cable Feed Through and Terminals, UHF, Mini-UHF, FME, Microdot, C, MHV, SHV, HV 4-10, HN



For very specific applications and requirements Rosenberger provides a wide range of coaxial connector series, e.g. UHF, Mini-UHF, FME, Microdot, C connectors, but also various series for high voltage applications. These connectors' product range is available on request.

The product spectrum also includes solder, clamp and crimp cable feed throughs as well as cable terminals for PCB applications

Für sehr spezifische Anwendungen und Anforderungen bietet Rosenberger eine ganze Reihe von Koaxial-Steckverbinder-Serien, z. B. UHF, Mini-UHF, FME, Microdot, C, aber auch verschiedene Serien für Hochspannungsanwendungen. Die Produkte sind auf Anfrage erhältlich.

Außerdem sind Löt-, Klemm- und Crimp-Kabelgehäusedurchführungen sowie Kabelabfangungen für Leiterplattenanwendungen verfügbar.

Cable Feed Through and Terminals
UHF, Mini-UHF
FME
Microdot
C
MHV, SHV, HV 4-10, HN



Cable Feed Through and Terminals

Cable Feed Through

Cable Feed Through, clamp

Rosenberger No.	Order No.	Sales Unit	Packaging	Cable Group	
51 Z 101-006 A	100656	25	standard	06, 07, 08	

Cable Terminals

Cable Terminal for PCB, straight, crimp

Rosenberger No.	Order No.	Sales Unit	Packaging	Cable Group	
29 Z 101-102 F	103565	100	standard	02	

Cable Terminal for PCB, straight, solder

Rosenberger No.	Order No.	Sales Unit	Packaging	Cable Group	
29 Z 102-271 L	102346	25	standard	71	

Cable Terminal for PCB, right angle, solder

Rosenberger No.	Order No.	Sales Unit	Packaging	Cable Group	
29 Z 210-202 F	103639	25	standard	02	

Interface Dimensions UHF

Code 54

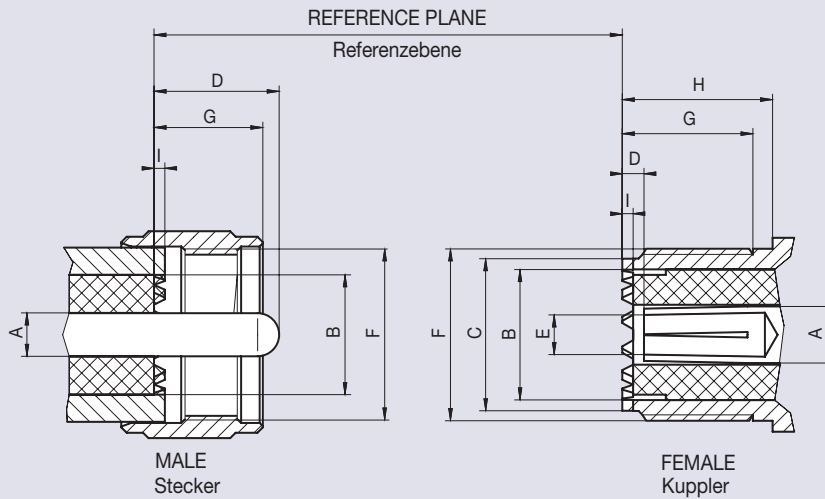

	Male Stecker		Female Kuppler	
	min.	max.	min.	max.
A	Ø 3.91	Ø 4.01		1)
B	Ø 11.56	Ø 12.22	Ø 11.56	Ø 12.22
C	–	–	Ø 14.00	Ø 14.25
D	–	11.10	1.02	–
E	–	–		1)
F	5/8-24 UNEF-2B		5/8-24 UNEF-2A	
G	–	9.91	7.87	–
H	–	–	11.10	–
I	–	0.89	0.89	–

Dimensions in mm

¹⁾ Resilient, dimension to meet electrical and mechanical requirements

Screw-on coaxial connectors with frontal interlocking teeth and without defined impedance, for low frequency applications up to 300 MHz, intermateable with banana connectors.

Koaxial-Steckverbinder mit Schraubverschluss und charakteristischer, stirnseitiger Verzahnung ohne definierten Wellenwiderstand, für Anwendungen mit geringen elektrischen Anforderungen (bis ca. 300 MHz), steckkompatibel mit Bananensteckern.

Features

- ▶ Interface according to IEC 60169-12
- ▶ Frequency range DC to 300 MHz
- ▶ Impedance not defined
- ▶ Screw-on coupling with notched edges

Product Range

Connectors are available on request

Technical Data UHF

Code 54

Applicable standards Anwendbare Normen	
Interface according to Interface gemäß	IEC 60169-12
Electrical data Elektrische Daten	
Impedance Wellenwiderstand	not defined
Frequency range Frequenzbereich	DC to 300 MHz
Insulation resistance Isolationswiderstand	≥ 5 GΩ
Center contact resistance Übergangswiderstand Innenleiter	≤ 5 mΩ
Outer contact resistance Übergangswiderstand Außenleiter	≤ 5 mΩ
Test voltage Prüfspannung	2000 V rms
Working voltage Betriebsspannung	750 V rms
Power handling Leistungsbelastbarkeit	400 W @ 300 MHz
Contact current Kontaktstrombelastbarkeit	≤ 10 A DC
Mechanical data Mechanische Daten	
Mating cycles Steckzyklen	≥ 500
Center contact captivation Innenleiter Haltekraft	axial: ≥ 30 N
Environmental data Umweltdaten	
Temperature range Temperaturbereich	-25 °C to +70 °C
Thermal shock Temperaturzyklen	MIL-STD-202, Method 107, Condition B
Corrosion resistance Korrosionsbeständigkeit	MIL-STD-202, Method 101, Condition B
Moisture resistance Feuchtigkeitsbeständigkeit	MIL-STD-202, Method 106
Vibration Vibration	MIL-STD-202, Method 204, Condition B
Shock Schock	MIL-STD-202, Method 213, Condition G
Max. soldering temperature (PCB connectors) Max. Löttemperatur (Leiterplattensteckverbinder)	IEC 61760-1, +260 °C for 10 sec.
Materials Materialien	
Spring loaded contact parts Federnde Kontaktteile	CuSn, Ag / Au plating
Center contact Innenleiter	CuZn, Ag / Au plating
Outer contact Außenleiter	CuZn, Ni plating
Crimping ferrule Crimphülse	Cu, Ni plating
Dielectric Dielektrikum	PS / PTFE
Gasket Dichtung	Silicone / Rubber

Rosenberger connectors generally fulfill the indicated technical data. Individual values of connectors may deviate depending upon application, design, type of cable, assembly method and workmanship. Data sheets for particular products can be downloaded on our website or can be provided on request from your Rosenberger sales partner.

Rosenberger-Steckverbinder erfüllen grundsätzlich die hier angegebenen technischen Daten. Je nach Anwendung, Bauart, Kabeltyp, Montageart und -ausführung können einzelne Werte der Steckverbinder hiervon abweichen. Datenblätter zu einzelnen Produkten können Sie von unserer Website herunterladen oder auf Anfrage von Ihrem Rosenberger-Ansprechpartner erhalten.

Interface Dimensions Mini-UHF

Code 24

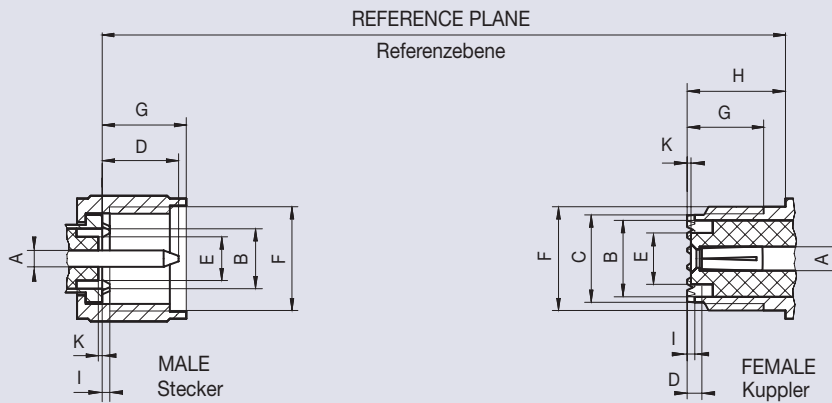

	Male Stecker		Female Kuppler	
	min.	max.	min.	max.
A	Ø 1.50	Ø 1.65	Ø 2.20 nom. ¹⁾	
B	Ø 5.50 nom.		–	Ø 7.00
C	–	–	Ø 7.90	Ø 8.10
D	6.00	7.30	0.80	2.00
E	Ø 4.00 nom.		Ø 4.70 nom.	
F	3/8-24 UNF-2B		3/8-24 UNF-2A	
G	6.50	8.00	6.50	–
H	–	–	8.50	–
I	0.63	0.77	0.63	0.77
K	0.00	0.70	0.00	0.50

Dimensions in mm

¹⁾ Resilient, dimension to meet electrical and mechanical requirements

Screw-on coaxial connectors, modified and miniaturized UHF connectors, with frontal interlocking teeth, with a defined impedance of 50 Ω and improved electrical characteristics for applications up to 2.5 GHz

Koaxial-Steckverbinder mit Schraubverschluss und charakteristischer, stirnseitiger Verzahnung, verkleinerte Bauform basierend auf UHF-Steckverbindern, aber mit definierten Wellenwiderstand von 50 Ω und verbesserten elektrischen Eigenschaften für Anwendungen bis 2, 5 GHz

Features

- ▶ Frequency range DC to 2.5 GHz
- ▶ Return loss (cable connector straight) ≥ 15 dB (typ.)
- ▶ Impedance 50 Ω
- ▶ Screw-on coupling with notched edges

Product Range

Connectors are available on request

Technical Data Mini-UHF

Code 24

Applicable standards Anwendbare Normen	
Interface according to Interface gemäß	N/A
Electrical data Elektrische Daten	
Impedance Wellenwiderstand	50 Ω
Frequency range Frequenzbereich	DC to 2.5 GHz
Return loss (cable connector straight) Rückflussdämpfung (Kabelsteckverbinder gerade)	≥ 15 dB (typ.)
Insertion loss Dämpfung	≤ 0.1 × √f (GHz) dB
Insulation resistance Isolationswiderstand	≥ 5 GΩ
Center contact resistance Übergangswiderstand Innenleiter	≤ 5 mΩ
Outer contact resistance Übergangswiderstand Außenleiter	≤ 3 mΩ
Test voltage Prüfspannung	1000 V rms
Working voltage Betriebsspannung	335 V rms
Contact current Kontaktstrombelastbarkeit	≤ 10 A DC
Mechanical data Mechanische Daten	
Mating cycles Steckzyklen	≥ 500
Center contact captivation Innenleiter Haltekraft	axial: ≥ 20 N
Environmental data Umweltdaten	
Temperature range Temperaturbereich	-55 °C to +85 °C
Corrosion resistance Korrosionsbeständigkeit	MIL-STD-202, Method 101, Condition B
Max. soldering temperature (PCB connectors) Max. Löttemperatur (Leiterplattensteckverbinder)	IEC 61760-1, +260 °C for 10 sec.
Materials Materialien	
Spring loaded contact parts Federnde Kontaktteile	CuSn, Ag plating
Center contact Innenleiter	CuZn, Ag plating
Outer contact Außenleiter	CuZn, Ni plating
Crimping ferrule Crimphülse	Cu, Ni plating
Dielectric Dielektrikum	PS / PTFE
Gasket Dichtung	Silicone / Rubber

Rosenberger connectors generally fulfill the indicated technical data. Individual values of connectors may deviate depending upon application, design, type of cable, assembly method and workmanship. Data sheets for particular products can be downloaded on our website or can be provided on request from your Rosenberger sales partner.

Rosenberger-Steckverbinder erfüllen grundsätzlich die hier angegebenen technischen Daten. Je nach Anwendung, Bauart, Kabeltyp, Montageart und -ausführung können einzelne Werte der Steckverbinder hiervon abweichen. Datenblätter zu einzelnen Produkten können Sie von unserer Website herunterladen oder auf Anfrage von Ihrem Rosenberger-Ansprechpartner erhalten.

Interface Dimensions FME

Code 26

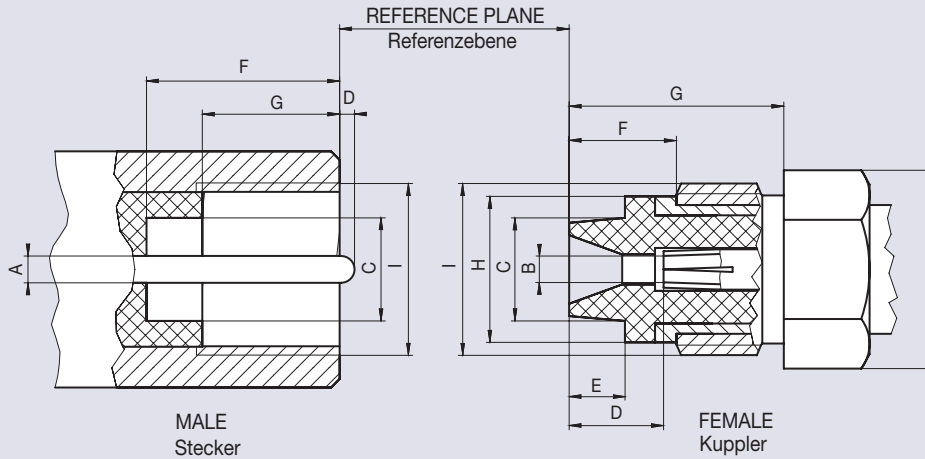

	Male Stecker		Female Kuppler	
	min.	max.	min.	max.
A	Ø 1.25 nom.		-	-
B	-	-	1)	
C	Ø 4.70	-	-	Ø 4.60
D	0.00	1.00	4.00	5.00
E	-	-	-	2.60
F	9.00	-	4.90	-
G	6.40	-	7.60	-
H	-	-	Ø 6.80 nom.	
I	M 8 x 0.75		M 8 x 0.75	
K	-	-	hex 8	

Dimensions in mm

¹⁾ Resilient, dimension to meet electrical and mechanical requirements

FME (SAP): coaxial connectors for mobile applications up to 3 GHz, mainly antenna connections in vehicles

FME (SAP): Koaxial-Steckverbinder für Mobilfunk-Anwendungen im Kfz bis 3 GHz

Features

- ▶ Interface according to Rosenberger FME
- ▶ Frequency range DC to 3 GHz
- ▶ Return loss (cable connector straight) ≥ 20 dB (typ.)
- ▶ Impedance 50 Ω
- ▶ Screw-on coupling

Product Range

Connectors are available on request

Technical Data FME

Code 26

Applicable standards Anwendbare Normen	
Interface according to Interface gemäß	Rosenberger FME intermateable with SAP
Electrical data Elektrische Daten	
Impedance Wellenwiderstand	50 Ω
Frequency range Frequenzbereich	DC to 3 GHz
Return loss (cable connector straight) Rückflussdämpfung (Kabelsteckverbinder gerade)	≥ 20 dB (typ.)
Insertion loss Dämpfung	≤ 0.1 x √f (GHz) dB
Insulation resistance Isolationswiderstand	≥ 5 GΩ
Center contact resistance Übergangswiderstand Innenleiter	≤ 10 mΩ
Outer contact resistance Übergangswiderstand Außenleiter	≤ 5 mΩ
Test voltage Prüfspannung	1000 V rms
Working voltage Betriebsspannung	500 V rms
Mechanical data Mechanische Daten	
Mating cycles Steckzyklen	≥ 300
Coupling torque recommended Drehmoment empfohlen	≤ 2 Nm
Environmental data Umweltdaten	
Temperature range Temperaturbereich	-55 °C to +125 °C
Corrosion resistance Korrosionsbeständigkeit	MIL-STD-202, Method 101
Vibration Vibration	MIL-STD-202, Method 204
Max. soldering temperature (PCB connectors) Max. Löttemperatur (Leiterplattensteckverbinder)	IEC 61760-1, +260 °C for 10 sec.
Materials Materialien	
Spring loaded contact parts Federnde Kontaktteile	CuSn, Ag plating
Center contact Innenleiter	CuZn, Ag plating
Outer contact Außenleiter	CuZn, Ni plating
Crimping ferrule Crimphülse	Cu, Ni plating
Dielectric Dielektrikum	PTFE
Gasket Dichtung	Rubber

Rosenberger connectors generally fulfill the indicated technical data. Individual values of connectors may deviate depending upon application, design, type of cable, assembly method and workmanship. Data sheets for particular products can be downloaded on our website or can be provided on request from your Rosenberger sales partner.

Rosenberger-Steckverbinder erfüllen grundsätzlich die hier angegebenen technischen Daten. Je nach Anwendung, Bauart, Kabeltyp, Montageart und -ausführung können einzelne Werte der Steckverbinder hiervon abweichen. Datenblätter zu einzelnen Produkten können Sie von unserer Website herunterladen oder auf Anfrage von Ihrem Rosenberger-Ansprechpartner erhalten.

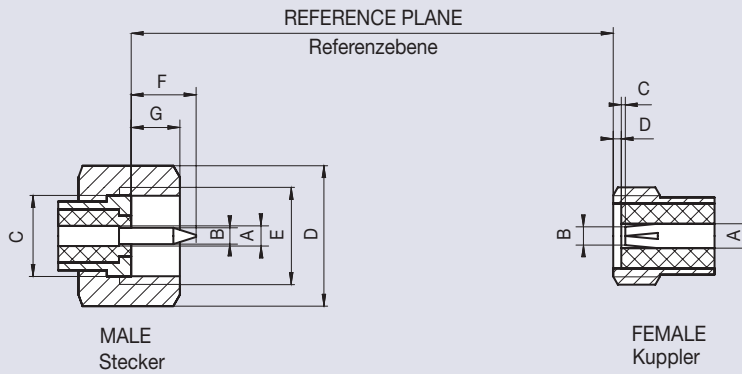

	Male Stecker		Female Kuppler	
	min.	max.	min.	max.
A	Ø 1.10 nom.		Ø 1.10 nom.	
B	Ø 0.85 nom.		1)	
C	Ø 4.00 nom.		0.00	0.40
D	hex 6		0.10	0.30
E	10-32 UNF-2B		10-32 UNF-2A	
F	3.60 nom.		-	-
G	2.50 nom.		-	-

Dimensions in mm

¹⁾ Resilient, dimension to meet electrical and mechanical requirements

Screw-on coaxial connectors for sensor applications up to 2 GHz with low noise cables

Koaxiale Schraubsteckverbinder bis 2 GHz in der Sensortechnik für rauscharme Kabel

Features

- ▶ Interface compatible with MALCO microdot
- ▶ Frequency range DC to 2 GHz
- ▶ Return loss (cable connector straight) ≥ 16 dB (typ.)
- ▶ Impedance 50 Ω
- ▶ Screw-on coupling

Product Range

Connectors are available on request

Technical Data Microdot

Code 31

Applicable standards Anwendbare Normen	
Interface intermateable with Interface steckkompatibel mit	MALCO microdot
Electrical data Elektrische Daten	
Impedance Wellenwiderstand	50 Ω
Frequency range Frequenzbereich	DC to 2 GHz
Return loss (cable connector straight) Rückflusdämpfung (Kabelsteckverbinder gerade)	≥ 16 dB (typ.)
Insertion loss Dämpfung	≤ 0.1 × √f (GHz) dB
Insulation resistance Isolationswiderstand	≥ 5 GΩ
Center contact resistance Übergangswiderstand Innenleiter	≤ 3 mΩ
Outer contact resistance Übergangswiderstand Außenleiter	≤ 3 mΩ
Test voltage Prüfspannung	1000 V rms
Contact current Kontaktstrombelastbarkeit	≤ 3 A DC
Mechanical data Mechanische Daten	
Mating cycles Steckzyklen	≥ 500
Environmental data Umweltdaten	
Temperature range Temperaturbereich	-65 °C to +125 °C
Thermal shock Temperaturzyklen	MIL-STD-202, Method 107, Condition B
Corrosion resistance Korrosionsbeständigkeit	MIL-STD-202, Method 101, Condition B
Moisture resistance Feuchtigkeitsbeständigkeit	MIL-STD-202, Method 106
Vibration Vibration	MIL-STD-202, Method 204, Condition B
Shock Schock	MIL-STD-202, Method 213, Condition H
Max. soldering temperature (PCB connectors) Max. Löttemperatur (Leiterplattensteckverbinder)	IEC 61760-1, +260 °C for 10 sec.
Materials Materialien	
Spring loaded contact parts Federnde Kontaktteile	CuBe, Au plating
Outer contact Außenleiter	CuZn, Au / Ni plating
Crimping ferrule Crimphülse	Cu, Au plating
Dielectric Dielektrikum	PTFE
Gasket Dichtung	Rubber

Rosenberger connectors generally fulfill the indicated technical data. Individual values of connectors may deviate depending upon application, design, type of cable, assembly method and workmanship. Data sheets for particular products can be downloaded on our website or can be provided on request from your Rosenberger sales partner.

Rosenberger-Steckverbinder erfüllen grundsätzlich die hier angegebenen technischen Daten. Je nach Anwendung, Bauart, Kabeltyp, Montageart und -ausführung können einzelne Werte der Steckverbinder hiervon abweichen. Datenblätter zu einzelnen Produkten können Sie von unserer Website herunterladen oder auf Anfrage von Ihrem Rosenberger-Ansprechpartner erhalten.

Interface Dimensions C 50 Ω

Code 52

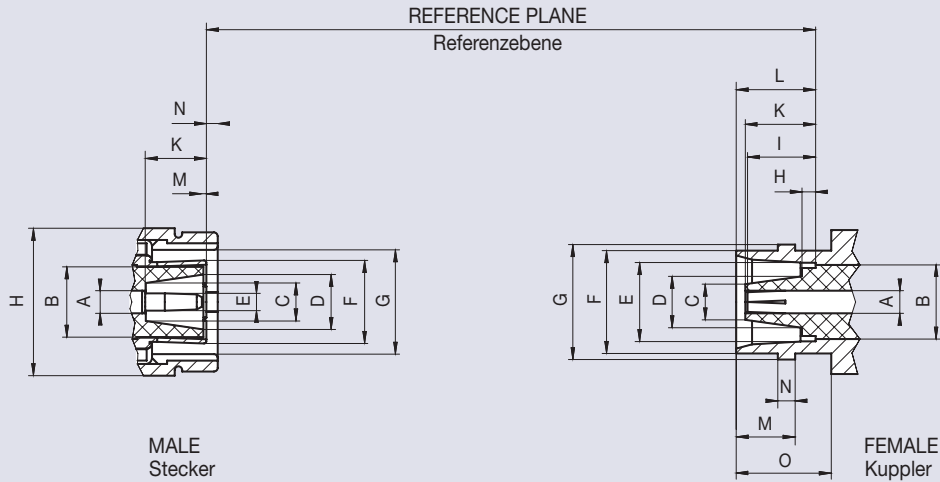

	Male Stecker		Female Kuppler	
	min.	max.	min.	max.
A	Ø 3.02	Ø 3.15	Ø 3.02	Ø 3.15
B	-	Ø 9.50	-	Ø 9.50
C	Ø 4.92	-	-	Ø 4.83
D	Ø 7.01	-	-	Ø 6.91
E	Ø 2.29	Ø 2.34	Ø 10.44	Ø 10.54
F		¹⁾	Ø 13.46	Ø 13.72
G	Ø 13.79	Ø 13.94	14.99	15.24
H	-	Ø 19.84	-	0.18
I	-	-	6.93	7.70
K	7.85	-	-	7.85
L	-	-	8.43	8.59
M	0.09	1.02	7.80	7.95
N	-	2.16	2.24	2.49
O	-	-	12.57	-

Dimensions in mm

¹⁾ Resilient, dimension to meet electrical and mechanical requirements

Coaxial connectors with two-stud bayonet coupling mechanism for applications up to 11 GHz for RF power transmission

Koaxial-Steckverbinder bis max. 11 GHz, mit 2-nockigem Bajonettverschluss, zur Übertragung hoher HF-Leistungen

Features

- ▶ Interface according to IEC 60169-7, MIL-PRF-39012, DIN 47222
- ▶ Frequency range DC to 11 GHz (max.), 4 GHz (opt.)
- ▶ Return loss (cable connector straight) ≥ 19 dB (typ.)
- ▶ Impedance 50 Ω
- ▶ Bayonet coupling

Product Range

Connectors are available on request

Technical Data C 50 Ω

Code 52

Applicable standards Anwendbare Normen	
Interface according to Interface gemäß	IEC 60169-7, MIL-PRF-39012, DIN 47222
Electrical data Elektrische Daten	
Impedance Wellenwiderstand	50 Ω
Frequency range Frequenzbereich	DC to 11 GHz (max.) DC to 4 GHz (opt.)
Return loss (cable connector straight) Rückflussdämpfung (Kabelsteckverbinder gerade)	≥ 19 dB (typ.)
Insertion loss Dämpfung	≤ 0.1 × √f (GHz) dB
Insulation resistance Isolationswiderstand	≥ 1 GΩ
Center contact resistance Übergangswiderstand Innenleiter	≤ 1 mΩ
Outer contact resistance Übergangswiderstand Außenleiter	≤ 0.25 mΩ
Test voltage Prüfspannung	3000 V rms
Working voltage Betriebsspannung	1000 V rms
Power handling Leistungsbelastbarkeit	400 W @ 1 GHz
Mechanical data Mechanische Daten	
Mating cycles Steckzyklen	≥ 500
Center contact captivation Innenleiter Haltekraft	axial: ≥ 20 N
Environmental data Umweltdaten	
Temperature range Temperaturbereich	-65 °C to +165 °C
Thermal shock Temperaturzyklen	MIL-STD-202, Method 107, Condition B
Corrosion resistance Korrosionsbeständigkeit	MIL-STD-202, Method 101, Condition B
Moisture resistance Feuchtigkeitsbeständigkeit	MIL-STD-202, Method 106
Vibration Vibration	MIL-STD-202, Method 204, Condition B
Shock Schock	MIL-STD-202, Method 213, Condition G
Max. soldering temperature (PCB connectors) Max. Löttemperatur (Leiterplattensteckverbinder)	IEC 61760-1, +260 °C for 10 sec.
Materials Materialien	
Spring loaded contact parts Federnde Kontaktteile	CuBe, Au plating
Center contact Innenleiter	CuZn, Au plating
Outer contact Außenleiter	CuZn, Ni plating
Crimping ferrule Crimphülse	Cu, Ni plating
Dielectric Dielektrikum	PTFE
Gasket Dichtung	Rubber

Rosenberger connectors generally fulfill the indicated technical data. Individual values of connectors may deviate depending upon application, design, type of cable, assembly method and workmanship. Data sheets for particular products can be downloaded on our website or can be provided on request from your Rosenberger sales partner.

Rosenberger-Steckverbinder erfüllen grundsätzlich die hier angegebenen technischen Daten. Je nach Anwendung, Bauart, Kabeltyp, Montageart und -ausführung können einzelne Werte der Steckverbinder hiervon abweichen. Datenblätter zu einzelnen Produkten können Sie von unserer Website herunterladen oder auf Anfrage von Ihrem Rosenberger-Ansprechpartner erhalten.

MHV (High Voltage BNC)

Interface Dimensions MHV (High Voltage BNC)

Code 41

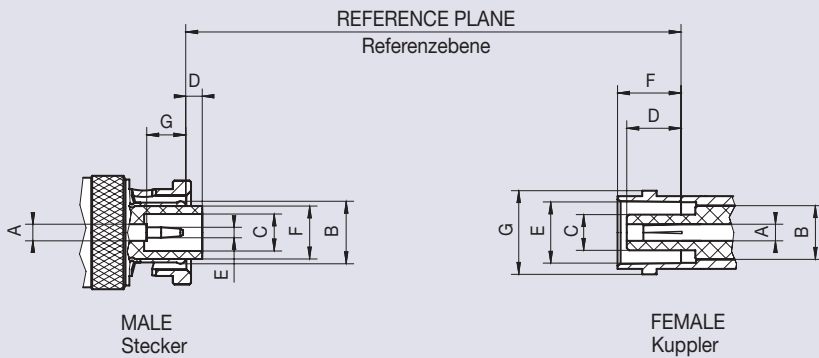

	Male Stecker		Female Kuppler	
	min.	max.	min.	max.
A	Ø 2.26	Ø 2.31	Ø 2.06	Ø 2.31
B	1)		Ø 7.21	Ø 7.37
C	Ø 4.83	Ø 4.93	–	Ø 4.72
D	–	2.18	7.34	7.90
E	Ø 1.32	Ø 1.37	Ø 8.10	Ø 8.15
F	Ø 7.06	Ø 7.16	8.31	8.51
G	7.62	–	10.97	11.07

Dimensions in mm

¹⁾ Resilient, dimension to meet electrical and mechanical requirements

MHV (Miniature High Voltage): coaxial high voltage connectors, based on BNC connectors, with two-stud bayonet locking system, for applications under highest safety demands up to 4 GHz. MHV and BNC connectors are not intermateable.

MHV (Miniature High Voltage): Koaxiale Hochspannungs-Steckverbinder auf Basis von BNC-Steckverbindern mit Bajonett-Verschluss für Anwendungen bis 4 GHz mit sehr hohen Sicherheitsanforderungen, nicht steckkompatibel mit BNC-Steckverbindern

Features

- ▶ Interface according to MIL-STD-348
- ▶ Frequency range DC to 300 MHz
- ▶ Working voltage 1600 V rms
- ▶ Impedance 50 Ω
- ▶ Bayonet coupling

Product Range

Connectors are available on request

Technical Data MHV (High Voltage BNC)

Code 41

Applicable standards Anwendbare Normen	
Interface according to Interface gemäß	MIL-STD-348, Fig. 303
Electrical data Elektrische Daten	
Impedance Wellenwiderstand	50 Ω
Frequency range Frequenzbereich	DC to 300 MHz
Insulation resistance Isolationswiderstand	≥ 5 GΩ
Center contact resistance Übergangswiderstand Innenleiter	≤ 2 mΩ
Outer contact resistance Übergangswiderstand Außenleiter	≤ 0.2 mΩ
Test voltage Prüfspannung	5000 V rms
Working voltage Betriebsspannung	1600 V rms
Mechanical data Mechanische Daten	
Mating cycles Steckzyklen	≥ 500
Coupling nut retention Überwurfmutter Haltekraft	≥ 450 N
Center contact captivation Innenleiter Haltekraft	axial: ≥ 18 N radial: ≥ 3 Ncm
Environmental data Umweltdaten	
Temperature range Temperaturbereich	-65 °C to +165 °C
Thermal shock Temperaturzyklen	MIL-STD-202, Method 107, Condition B
Climatic category Klimakategorie	IEC 60068-2-1 65/165/21
Corrosion resistance Korrosionsbeständigkeit	MIL-STD-202, Method 101, Condition B
Moisture resistance Feuchtigkeitsbeständigkeit	MIL-STD-202, Method 106
Vibration Vibration	MIL-STD-202, Method 204, Condition B
Shock Schock	MIL-STD-202, Method 213, Condition G
Max. soldering temperature (PCB connectors) Max. Löttemperatur (Leiterplattensteckverbinder)	IEC 61760-1, +260 °C for 10 sec.
Materials Materialien	
Spring loaded contact parts Federnde Kontaktteile	CuBe, Au plating
Center contact Innenleiter	CuZn, Au plating
Outer contact Außenleiter	CuZn, white bronze plating
Crimping ferrule Crimphülse	Cu, white bronze plating
Dielectric Dielektrikum	PTFE
Gasket Dichtung	Rubber

Rosenberger connectors generally fulfill the indicated technical data. Individual values of connectors may deviate depending upon application, design, type of cable, assembly method and workmanship. Data sheets for particular products can be downloaded on our website or can be provided on request from your Rosenberger sales partner.

Rosenberger-Steckverbinder erfüllen grundsätzlich die hier angegebenen technischen Daten. Je nach Anwendung, Bauart, Kabeltyp, Montageart und -ausführung können einzelne Werte der Steckverbinder hiervon abweichen. Datenblätter zu einzelnen Produkten können Sie von unserer Website herunterladen oder auf Anfrage von Ihrem Rosenberger-Ansprechpartner erhalten.

SHV (Safe High Voltage)

Interface Dimensions SHV (Safe High Voltage)

Code 57

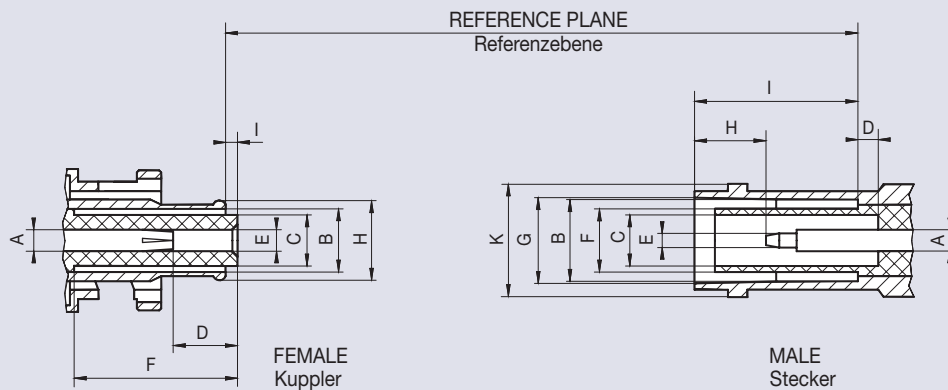

	Female Kuppler		Male Stecker	
	min.	max.	min.	max.
A	Ø 2.06	Ø 2.11	Ø 2.06	Ø 2.11
B	Ø 6.71	–	Ø 8.10	Ø 8.15
C	Ø 4.57	Ø 4.72	Ø 4.83	Ø 4.98
D	6.05	6.65	1.63	2.18
E	Ø 2.08	–	Ø 1.32	Ø 1.37
F	15.95	16.05	–	Ø 6.60
G	–	–	Ø 8.33	Ø 8.46
H	1)		6.32	7.26
I	1.17	1.63	15.90	16.00
K	–	–	10.97	11.07

Dimensions in mm

¹⁾ Resilient, dimension to meet electrical and mechanical requirements

SHV (Safe High Voltage - Nuclear Instrumentation Module Standard): Reverse polarity, coaxial high voltage connectors with two-stud bayonet locking system, based on BNC connectors, for applications under highest safety demands up to 4 GHz, e.g. in nuclear engineering. SHV and BNC connectors are not interchangeable.

SHV (Safe High Voltage - Nuclear Instrumentation Module Standard): Reverse Polarity-Steckverbinder - Koaxiale Hochspannungs-Steckverbinder auf Basis von BNC-Steckverbindern mit Bajonett-Verschluss für Anwendungen bis 4 GHz mit sehr hohen Sicherheitsanforderungen, z.B. in der Kerntechnik, nicht steckkompatibel mit BNC-Steckverbindern

Features

- ▶ Interface according to MIL-STD-348 Fig. 314, IEC 60498
- ▶ Frequency range DC to 300 MHz
- ▶ Working voltage 3500 V rms
- ▶ Impedance 50 Ω
- ▶ Bayonet coupling
- ▶ Reverse polarity

Product Range

Connectors are available on request

Technical Data SHV (Safe High Voltage)

Code 57

Applicable standards Anwendbare Normen	
Interface according to Interface gemäß	MIL-STD-348 Fig. 314, IEC 60498
Electrical data Elektrische Daten	
Impedance Wellenwiderstand	50 Ω
Frequency range Frequenzbereich	DC to 300 MHz
Insulation resistance Isolationswiderstand	≥ 10 ⁹ GΩ
Center contact resistance Übergangswiderstand Innenleiter	≤ 2 mΩ
Outer contact resistance Übergangswiderstand Außenleiter	≤ 1.5 mΩ
Test voltage Prüfspannung	5000 V rms
Working voltage Betriebsspannung	3500 V rms 5000 V DC
Operating current Betriebsstrom	500 mA (average) 10 A (peak)
Mechanical data Mechanische Daten	
Mating cycles Steckzyklen	≥ 500
Coupling nut retention Überwurfmutter Haltekraft	≥ 450 N
Center contact captivation Innenleiter Haltekraft	axial: ≥ 27 N radial: ≥ 3 Ncm
Environmental data Umweltdaten	
Temperature range Temperaturbereich	-55 °C to +155 °C
Thermal shock Temperaturzyklen	MIL-STD-202, Method 107, Condition B
Climatic category Klimakategorie	IEC 60068-2-1 55/155/21
Corrosion resistance Korrosionsbeständigkeit	MIL-STD-202, Method 101, Condition B
Moisture resistance Feuchtigkeitsbeständigkeit	MIL-STD-202, Method 106
Vibration Vibration	MIL-STD-202, Method 204, Condition A
Shock Schock	MIL-STD-202, Method 213, Condition I
Max. soldering temperature (PCB connectors) Max. Löttemperatur (Leiterplattensteckverbinder)	IEC 61760-1, +260 °C for 10 sec.
Materials Materialien	
Spring loaded contact parts Federnde Kontaktteile	CuBe, Au plating
Center contact Innenleiter	CuZn, Au plating
Outer contact Außenleiter	CuZn, white bronze plating
Crimping ferrule Crimphülse	Cu, white bronze plating
Dielectric Dielektrikum	PTFE
Gasket Dichtung	Rubber

Rosenberger connectors generally fulfill the indicated technical data. Individual values of connectors may deviate depending upon application, design, type of cable, assembly method and workmanship. Data sheets for particular products can be downloaded on our website or can be provided on request from your Rosenberger sales partner.

Rosenberger-Steckverbinder erfüllen grundsätzlich die hier angegebenen technischen Daten. Je nach Anwendung, Bauart, Kabeltyp, Montageart und -ausführung können einzelne Werte der Steckverbinder hiervon abweichen. Datenblätter zu einzelnen Produkten können Sie von unserer Website herunterladen oder auf Anfrage von Ihrem Rosenberger-Ansprechpartner erhalten.

HV 4-10 (High Voltage C)

Interface Dimensions HV 4-10 (High Voltage C)

Code 42

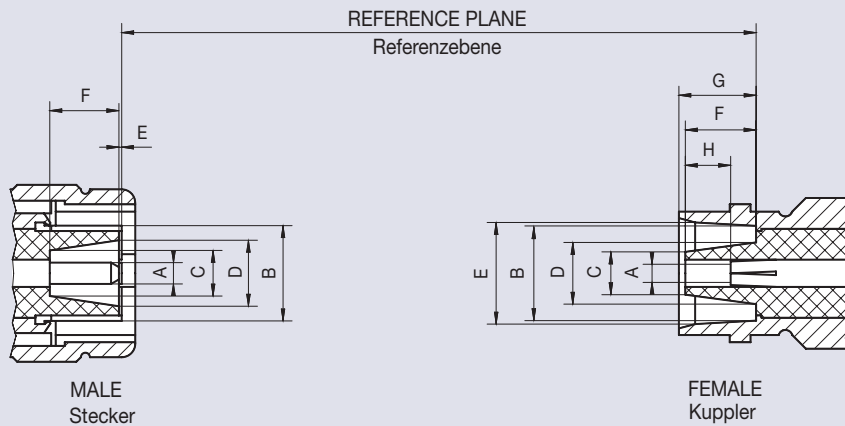

	Male Stecker		Female Kuppler	
	min.	max.	min.	max.
A	Ø 2.36	Ø 2.41		¹⁾
B		¹⁾	Ø 10.44	Ø 10.54
C	Ø 5.03	Ø 5.13	Ø 4.62	Ø 4.72
D	Ø 7.27	Ø 7.37	Ø 6.55	Ø 6.65
E	0.16	0.50	Ø 11.17	Ø 11.30
F	7.57	7.67	7.75	7.85
G	-	-	8.43	8.59
H	-	-	4.80	5.00

Dimensions in mm

¹⁾ Resilient, dimension to meet electrical and mechanical requirements

HV 4-10 (High Voltage C): coaxial high voltage connectors with two-stud bayonet locking system, based on C connectors, for high voltage applications up to 2 GHz, e.g. Geiger-Mueller tubes. HV 4-10 and C connectors are not intermateable.

HV 4-10 (High Voltage C): Koaxiale Hochspannungs-Steckverbinder auf Basis von C-Steckverbindern, mit Bajonett-Verschluss, für Hochspannungsanwendungen bis 2 GHz, besonders Geiger-Müller-Zählrohre, nicht steckkompatibel mit C-Steckverbindern

Features

- ▶ Interface according to DIN 44424
- ▶ Working voltage 5000 V rms
- ▶ Impedance 50 Ω
- ▶ Bayonet coupling

Product Range

Connectors are available on request

Technical Data HV 4-10 (High Voltage C)

Code 42

Applicable standards Anwendbare Normen	
Interface according to Interface gemäß	DIN 44424
Electrical data Elektrische Daten	
Impedance Wellenwiderstand	50 Ω
Insulation resistance Isolationswiderstand	≥ 10 ⁴ GΩ
Test voltage Prüfspannung	7000 V rms
Working voltage Betriebsspannung	5000 V rms
Operating current Betriebsstrom	≤ 1 A
Mechanical data Mechanische Daten	
Mating cycles Steckzyklen	≥ 500
Center contact captivation Innenleiter Haltekraft	axial: ≥ 27 N
Environmental data Umweltdaten	
Temperature range Temperaturbereich	-55 °C to +155 °C
Thermal shock Temperaturzyklen	MIL-STD-202, Method 107, Condition B
Corrosion resistance Korrosionsbeständigkeit	MIL-STD-202, Method 101, Condition B
Moisture resistance Feuchtigkeitsbeständigkeit	MIL-STD-202, Method 106
Vibration Vibration	MIL-STD-202, Method 204, Condition B
Shock Schock	MIL-STD-202, Method 213, Condition G
Max. soldering temperature (PCB connectors) Max. Löttemperatur (Leiterplattensteckverbinder)	IEC 61760-1, +260 °C for 10 sec.
Materials Materialien	
Spring loaded contact parts Federnde Kontaktteile	CuBe, Au plating
Center contact Innenleiter	CuZn, Au plating
Outer contact Außenleiter	CuZn, white bronze plating
Crimping ferrule Crimphülse	Cu, white bronze plating
Dielectric Dielektrikum	PTFE
Gasket Dichtung	Rubber

Rosenberger connectors generally fulfill the indicated technical data. Individual values of connectors may deviate depending upon application, design, type of cable, assembly method and workmanship. Data sheets for particular products can be downloaded on our website or can be provided on request from your Rosenberger sales partner.

Rosenberger-Steckverbinder erfüllen grundsätzlich die hier angegebenen technischen Daten. Je nach Anwendung, Bauart, Kabeltyp, Montageart und -ausführung können einzelne Werte der Steckverbinder hiervon abweichen. Datenblätter zu einzelnen Produkten können Sie von unserer Website herunterladen oder auf Anfrage von Ihrem Rosenberger-Ansprechpartner erhalten.

HN (High Voltage N)

Interface Dimensions HN (High Voltage N)

Code 43

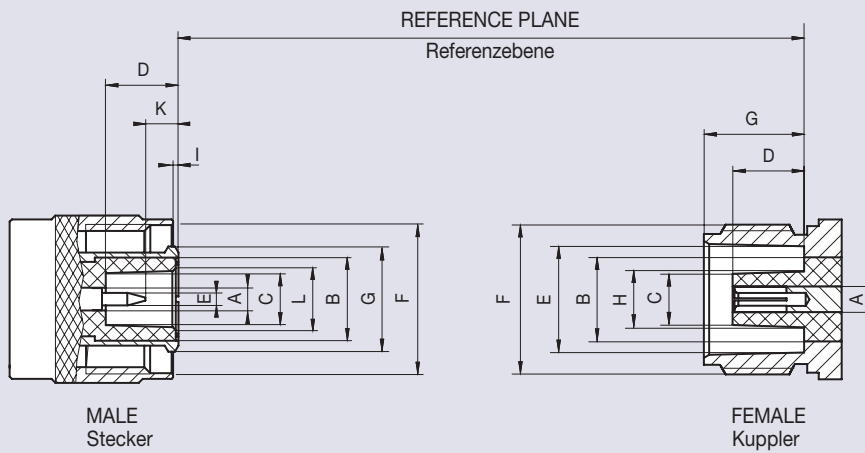

	Male Stecker		Female Kuppler	
	min.	max.	min.	max.
A	–	Ø 3.35	–	Ø 3.35
B	Ø 11.00 nom. ¹⁾		–	Ø 10.92
C	Ø 6.68	–	–	Ø 6.81
D	9.35		–	9.35
E	Ø 1.67	Ø 1.68	Ø 13.92	Ø 14.05
F	3/4-20 UNEF-2B		3/4-20 UNEF-2A	
G	¹⁾		13.11	13.26
H	–	–	–	Ø 7.47
I	0.40	1.40	–	–
K	3.51	–	–	–
L	Ø 7.34	–	–	–

Dimensions in mm

¹⁾ Resilient, dimension to meet electrical and mechanical requirements

HN (High Voltage N): coaxial high voltage connectors, based on N connectors, with screw-on locking mechanism, for applications up to 4 GHz, especially for pulsed operations. HN and N connectors are not intermateable.

HN (High Voltage N): Koaxiale Hochspannungs-Steckverbinder auf Basis von N-Steckverbindern, mit Schraub-Verschluss, für Hochspannungsanwendungen bis 4 GHz, besonders für Impulsbetrieb, nicht steckkompatibel mit N-Steckverbindern

Features

- ▶ Interface according to MIL-STD-348
- ▶ Frequency range DC to 4 GHz
- ▶ Working voltage 2500 V rms
- ▶ Impedance 50 Ω
- ▶ Screw coupling

Product Range

Connectors are available on request

Technical Data HN (High Voltage N)

Code 43

Applicable standards Anwendbare Normen	
Interface according to Interface gemäß	MIL-STD-348 Fig. 317
Electrical data Elektrische Daten	
Impedance Wellenwiderstand	50 Ω
Frequency range Frequenzbereich	DC to 4 GHz
Return loss (cable connector straight) Rückflusdämpfung (Kabelsteckverbinder gerade)	≥ 20 dB @ DC to 2 GHz ≥ 17 dB @ 2 GHz to 4 GHz
Insertion loss Dämpfung	≤ 0.1 x √f (GHz) dB
Insulation resistance Isolationswiderstand	≥ 10 GΩ
Center contact resistance Übergangswiderstand Innenleiter	≤ 8 mΩ
Outer contact resistance Übergangswiderstand Außenleiter	≤ 2 mΩ
Test voltage Prüfspannung	3500 V rms
Working voltage Betriebsspannung	2500 V rms
RF leakage - Interface Schirmdämpfung	≥ 128 dB @ DC to 1 GHz
Mechanical data Mechanische Daten	
Mating cycles Steckzyklen	≥ 500
Coupling test torque Prüfdrehmoment	≤ 1.7 Nm
Coupling torque recommended Drehmoment empfohlen	0.7 Nm to 1.1 Nm
Environmental data Umweltdaten	
Temperature range Temperaturbereich	-65 °C to +155 °C
Thermal shock Temperaturzyklen	MIL-STD-202, Method 107, Condition B
Climatic category Klimakategorie	IEC 60068-2-1 65/155/21
Corrosion resistance Korrosionsbeständigkeit	MIL-STD-202, Method 101, Condition B
Moisture resistance Feuchtigkeitsbeständigkeit	MIL-STD-202, Method 106
Vibration Vibration	MIL-STD-202, Method 204, Condition B
Shock Schock	MIL-STD-202, Method 213, Condition I
Max. soldering temperature (PCB connectors) Max. Löttemperatur (Leiterplattensteckverbinder)	IEC 61760-1, +260 °C for 10 sec.
Materials Materialien	
Spring loaded contact parts Federnde Kontaktteile	CuBe, Ag plating
Center contact Innenleiter	CuZn, Ag plating
Outer contact Außenleiter	CuZn, Ni plating
Crimping ferrule Crimphülse	Cu, Ni plating
Dielectric Dielektrikum	PTFE
Gasket Dichtung	Rubber

Rosenberger connectors generally fulfill the indicated technical data. Individual values of connectors may deviate depending upon application, design, type of cable, assembly method and workmanship. Data sheets for particular products can be downloaded on our website or can be provided on request from your Rosenberger sales partner.

Rosenberger-Steckverbinder erfüllen grundsätzlich die hier angegebenen technischen Daten. Je nach Anwendung, Bauart, Kabeltyp, Montageart und -ausführung können einzelne Werte der Steckverbinder hiervon abweichen. Datenblätter zu einzelnen Produkten können Sie von unserer Website herunterladen oder auf Anfrage von Ihrem Rosenberger-Ansprechpartner erhalten.

Tools

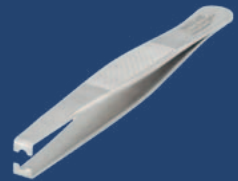

Rosenberger provides a wide range of tools such as crimping tools, crimp inserts, torque wrenches or extraction tools.

To select tools for specific connectors or applications, please see Rosenberger data sheets and / or assembly instructions.

Rosenberger bietet ein umfangreiches Spektrum an Werkzeugen, z.B. Crimpzangen, Crimpeinsätze, Drehmomentschlüssel oder Ausdrückwerkzeuge.

Die für bestimmte Steckverbinder bzw. Anwendungen benötigten Werkzeuge sind in Rosenberger- Datenblättern bzw. -Montageanleitungen beschrieben

Crimping Tools & Inserts
Extraction Tools
Torque Wrenches



Tools

Crimping Tool

Rosenberger No.	Order No.	Sales Unit	Packaging	Remarks	
11 W 150-000	151067	1	box	MIL-STD-22520/5 without crimp insert choose crimp inserts 11W150-xxx	

Crimp Inserts 11 W 150-1xx

for 11 W 150-000

Rosenberger No.	Order No.	Sales Unit	Packaging	Remarks	
11 W 150-101	101715	1	standard	crimp insert for outer contact crimp only width 2.75 mm	
11 W 150-102	102924	1	standard	crimp insert for outer contact crimp only width 3.30 mm	
11 W 150-103	101038	1	standard	crimp insert for outer contact crimp only width 3.63 mm	
11 W 150-104	102474	1	standard	crimp insert for outer contact crimp only width 4.30 mm	
11 W 150-150	108582	1	standard	crimp insert for outer contact crimp only width 4.55 mm	
11 W 150-108	103824	1	standard	crimp insert for outer contact crimp only width 5.50 mm	
11 W 150-109	108658	1	standard	crimp insert for outer contact crimp only width 6.50 mm	
11 W 150-115	100386	1	standard	crimp insert for outer contact crimp only width 10.90 mm	

Crimp Inserts 11 W 150-2xx

for 11 W 150-000

Rosenberger No.	Order No.	Sales Unit	Packaging	Remarks
11 W 150-204	103036	1	standard	crimp insert for outer & center contact crimp width outer contact 4.30 mm; width center contact 1.75 mm
11 W 150-208	103188	1	standard	crimp insert for outer & center contact crimp width outer contact 5.50 mm; width center contact 1.75 mm
11 W 150-209	107133	1	standard	crimp insert for outer & center contact crimp width outer contact 6.50 mm; width center contact 1.75 mm
11 W 150-213	100874	1	standard	crimp insert for outer & center contact crimp width outer contact 7.35 mm; width center contact 1.75 mm
11 W 150-215	100369	1	standard	crimp insert for outer & center contact crimp width outer contact 10.90 mm; width center contact 2.52 mm



Crimp Inserts 11 W 150-4xx

for 11 W 150-000

Rosenberger No.	Order No.	Sales Unit	Packaging	Remarks
11 W 15R-401	227692	1	standard	crimp insert for outer & center contact crimp width outer contact 2.45 mm; width center contact 0.65 mm
11 W 150-401	105653	1	standard	crimp insert for outer & center contact crimp width outer contact 2.75 mm; width center contact 0.75 mm
11 W 152-402	106436	1	standard	crimp insert for outer & center contact crimp width outer contact 3.20 mm; width center contact 0.73 mm
11 W 150-402	100209	1	standard	crimp insert for outer & center contact crimp width outer contact 3.30 mm; width center contact 0.73 mm
11 W 150-403	103235	1	standard	crimp insert for outer & center contact crimp width outer contact 3.63 mm; width center contact 0.73 mm
11 W 150-404	106114	1	standard	crimp insert for outer & center contact crimp width outer contact 4.30 mm; width center contact 0.73 mm
11 W 150-450	102835	1	standard	crimp insert for outer & center contact crimp width outer contact 4.55 mm; width center contact 0.73 mm



Crimp Inserts 11 W 150-5xx

for 11 W 150-000

Rosenberger No.	Order No.	Sales Unit	Packaging	Remarks
11 W 15A-502	142923	1	standard	crimp insert for outer & center contact crimp width outer contact 3.30 mm; width center contact 1.20 mm
11 W 150-504	100686	1	standard	crimp insert for outer & center contact crimp width outer contact 4.30 mm; width center contact 1.10 mm
11 W 15A-504	138519	1	standard	crimp insert for outer & center contact crimp width outer contact 4.30 mm; width center contact 1.10 mm
11 W 150-550	105477	1	standard	crimp insert for outer & center contact crimp width outer contact 4.55 mm; width center contact 1.20 mm
11 W 150-506	100737	1	standard	crimp insert for outer & center contact crimp width outer contact 5.35 mm; width center contact 1.10 mm
11 W 150-508	108672	1	standard	crimp insert for outer & center contact crimp width outer contact 5.50 mm; width center contact 1.10 mm
11 W 15A-508	142922	1	standard	crimp insert for outer & center contact crimp width outer contact 5.50 mm; width center contact 1.10 mm



Extraction Tools

Rosenberger No.	Order No.	Sales Unit	Packaging	Remarks	
28 W 001-000	146488	1	standard	extraction tool for QMA Locking Nut	
18 W 002-000	147669	1	standard	extraction tool for Mini-SMP connectors	
19 W 002-000	104203	1	standard	extraction tool for SMP connectors	
19 W 009-000	214301	1	box	extraction tool for SMP connectors	
11 W 102-000	104300	1	standard	extraction tool for DIN 41626 inserts	
11 W 102-001	108279	1	standard	replacement sleeve for extraction tool 11W102-000	

Socket Wrench

Rosenberger No.	Order No.	Sales Unit	Packaging	Remarks	
78 W 101-000	101701	1	box	socket wrench for series 1.6-5.6, slot 1.45 mm	

Torque Wrenches

for Inserts

Rosenberger No.	Order No.	Sales Unit	Packaging	Remarks	
32 W 100-016	103855	1	standard	SMA torque 0.9 Nm flat 8 mm	
53 W 008-000	104745	1	standard	N torque 1.1 Nm flat 18 mm	
60 W 000-002	205478	1	standard	7-16 torque 25 Nm flat 32 mm	
64 W 021-001	285127	1	standard	4.3-10 torque 5 Nm flat 22 mm	
64 W 021-002	285128	1	standard	4.1-9.5 torque 10 Nm flat 22 mm	

Assembly Tool Kit SMA

for Semi-Rigid Cables

Rosenberger No.	Order No.	Sales Unit	Packaging	Remarks	
32 W 100-000	102773	1	box	complete tool set in plastic box	

Contents of the Assembly Tool Kit for Semi Rigid Cables (32 W 100-000)

Rosenberger No.	Order No.	Sales Unit	Packaging	Remarks
32 W 100-001	102044	1	standard	Soldering Fixture Lötvorrichtung
32 W 100-002	104396	1	standard	Insert for RG 405 Backen für RG 405
32 W 100-003	105898	1	standard	Insert for RG 405 Backen für RG 405
32 W 100-004	102850	1	standard	Jack Locator Fixierschraube für Kuppler
32 W 100-005	104607	1	standard	Plug Locator Fixierschraube für Stecker
32 W 100-006	102502	1	standard	Soldering Gauge 0.25 mm Distanzlehre 0.25 mm
32 W 100-007	100680	1	standard	Soldering Gauge 0.4 mm Distanzlehre 0.4 mm
32 W 100-008	106817	1	standard	Contact Support (for Plug and Jack) Kontakthalter (für Stecker und Kuppler)
32 W 100-009	103318	1	standard	Dielectric Insertion Tool for Plug Isolierteil-Einpresswerkzeug für Stecker
32 W 100-010	107090	1	standard	Dielectric Insertion Tool for Jack Isolierteil-Einpresswerkzeug für Kuppler
32 W 100-011	108733	1	standard	Assembly Jig (Center Contact + Insulator) Montagelehre (Innenleiter + Isolierteil)
32 W 100-012	100798	1	standard	Assembly Jig (Outer Contact + Coupling Nut) Montagelehre (Außenleiter + Überwurfmutter)
32 W 100-013	102523	1	standard	Assembly Jig (Center Contact + Insulator) Montagelehre (Innenleiter + Isolierteil)
32 W 100-014	104294	1	standard	Cutting Tool Planschneidewerkzeug
32 W 100-015	108584	1	standard	Sharpening Tool Anspitzwerkzeug
32 W 100-016	103855	1	standard	Torque Wrench (0.9 Nm) Drehmomentschlüssel (0.9 Nm)
32 W 100-017	103665	1	standard	Insulator Insertion Tool Andrückwerkzeug für Isolierteil
32 W 100-018	103451	1	standard	Insulator Press-in Tool Einpresswerkzeug für Isolierteil
32 W 100-022/01	119710	1	standard	Conical Sleeve Kegelhülse
32 W 100-022/02	112888	1	standard	Arrester Gegenhalter
32 W 100-022/03	109562	1	standard	Fixing Tool I Stössel I
32 W 100-022/04	121928	1	standard	Fixing Tool II Stössel II

Stripping Tool

for Semi-Rigid Cables

Rosenberger No.	Order No.	Sales Unit	Packaging	Remarks	
32 W 100-023	106546	1	standard	stripping tool for Semi-Rigid Cable, UT 85 and UT 141	

Distance Gauge

Rosenberger No.	Order No.	Sales Unit	Packaging	Remarks	
11 W 115-000	150600	1	standard	distance gauge for SMP connectors width 0.6 mm, thickness 0.5 mm	

Packaging, Index

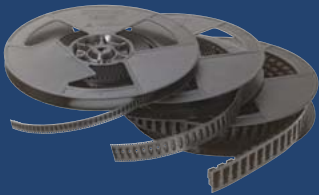

Packaging Index

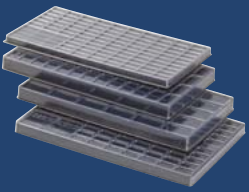

Packaging

Definition of the most commonly used product packaging:

Verpackung

Definition der gängigsten Produktverpackungen:

Standard

Plastic bag in various sizes.

Kunststoffbeutel in verschiedenen Größen.

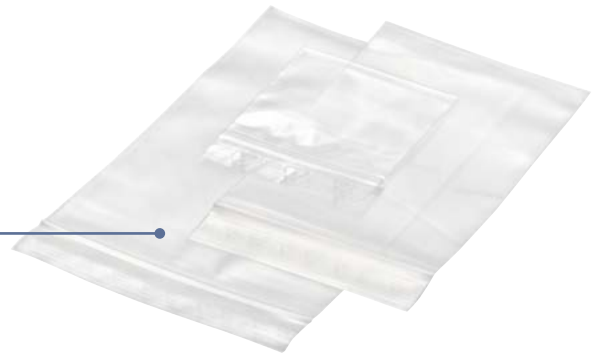

Box

Cartons in various sizes. Most are provided with additional internal packing materials e.g. partition walls or foam inlays.

Kartons in verschiedenen Größen. Meist mit zusätzlichen Innenverpackungen z.B. Trennwände oder Schaumstoffeinlagen.



Blister

2-piece plastic blister packaging with transparent cover in several heights and for various numbers of pieces.

2-teilige Kunststoffblister mit transparentem Deckel in mehreren Höhen und für verschiedene Stückzahlen.



Tape & Reel

Carrier tapes on rolls in various variants for automatic machine mounting e.g. of PCB connectors.

Blistergurte auf Rollen in verschiedenen Varianten für die automatische Bestückung z.B. von Leiterplatten-Steckverbindern.



Rosenberger Numbers

02 K 118-K00 S3	49	119 S 102-40M L5	74	19 K 101-K00 L5	32
02 K 118-S00 S3	49	119 S 103-40M L5	74	19 K 101-K20 D3	32
02 K 119-K00 E3	34	119 S 104-40M L5	74	19 K 102-101 L5	27
02 K 119-S00 E3	34	119 S 10B-40M L5	74	19 K 102-1X1 L5	27
02 S 118-K00 S3	49	119 S 132-K00 S5	77, 93	19 K 102-K00 L5	32
02 S 118-S00 S3	49	119 S 132-S00 S5	77, 93	19 K 104-K00 L5	32
02 S 119-K00 E3	34	119 S 141-40M L5	74	19 K 106-K00 L5	32
02 S 119-S00 E3	34	119 S 142-40M L5	74	19 K 107-270 L5	26
03 K 128-K20 N3	118	119 S 143-40M L5	74	19 K 107-271 L5	26
03 K 128-S20 N3	118	119 S 144-40M L5	74	19 K 107-K00 L5	32
03 K 717-S22 S5	41	119 S 147-40M L5	74	19 K 108-K00 L5	32
03 K 719-S22 S3	34	119 S 14N-40M L5	74	19 K 109-K00 L5	32
03 K 719-S60 S3	76	119 S 202-40M L5	75	19 K 110-K00 L5	32
03 K 728-S22 S3	118	119 S 242-40M L5	75	19 K 114-K00 L5	32
03 S 128-K20 N3	118	119 S 601-500 N5	73	19 K 115-K00 L5	32
03 S 128-S20 N3	118	119 S 641-500 N5	73	19 K 116-K00 L5	32
05 K 132-K00 S3	102	119 S 64A-500 N5	73	19 K 117-K00 L5	32
05 K 132-S00 S3	102	15 C 102-40M L5-NM	299	19 K 119-K00 L5	32
05 K 151-K20 S3	192	15 K 101-40M E4	298	19 K 119-K06 L5	32
05 K 160-K50 D3	281	15 S 132-K02 L5	103, 299	19 K 119-K11 L5	32
05 K 160-S50 D3	281	15 S 132-K04 L5	103, 299	19 K 119-K38 L5	32
05 K 432-K00 S3	102	15 S 132-K05 L5	103, 299	19 K 132-K00 D3	33, 100
05 K 432-S00 S3	102	153Q K 153-K00 N5	229, 247	19 K 132-S00 D3	33, 100
05 S 132-K00 S3	102	153Q K 153-S00 N5	229, 247	19 K 15R-001 E4	35
05 S 132-S00 S3	102	153Q K 160-S00 N5	247, 278	19 K 201-302 L5	27
05 S 151-S20 S3	192	153Q K 401-200 N5	246	19 K 201-303 L5	27
05 S 160-K50 D3	281	153Q K 601-115 N5	245	19 K 202-270 L5	26
05 S 160-S50 D3	281	153Q K 601-272 N5	244	19 K 202-271 L5	26
05 S 432-K00 S3	102	153Q K 607-106 N5	245	19 K 202-301 L5	27
05 S 432-S00 S3	102	153Q K 607-108 N5	245	19 K 203-3X1 L5	27
06 K 132-K00 S3	103	153Q S 101-115 N5	245	19 S 101-40M L5	29
06 K 132-S00 S3	103	153Q S 102-272 N5	244	19 S 101-K20 D3	32
06 S 132-K00 S3	103	153Q S 108-106 N5	245	19 S 101-S20 D3	32
06 S 132-S00 S3	103	153Q S 108-108 N5	245	19 S 102-400 L5	31
07 P 132-K00 S3	103	153Q S 153-K00 N5	229, 247	19 S 102-40M L5	29
07 P 132-S00 S3	103	153Q S 156-K00 N5	214, 247	19 S 103-400 L5	29
07 P 151-K00 S3	193	153Q S 202-272 N5	244	19 S 103-500 L5	29
07 P 151-S00 S3	193	153Q S 205-306 N5	245	19 S 104-40M L5	29
08 K 118-K00 S3	48	153Q S 205-308 N5	245	19 S 105-500 L5	28
08 K 118-S00 S3	48	153Q S 205-315 N5	245	19 S 106-500 L5	29
08 S 118-K00 S3	48	16 P 101-40M L4	56	19 S 10A-400 L5	29
08 S 118-S00 S3	48	16 P 141-40M L4	56	19 S 10D-40M L5	30
11 W 102-000	165, 326	16 S 101-S00 L5	57	19 S 10H-40M L5	29
11 W 102-001	165, 326	16 S 102-S00 L5	57	19 S 122-40M L5	29
11 W 115-000	35, 329	16 S 132-K00 L5	57, 101	19 S 132-K00 S3	33, 100
11 W 150-000	324	16 S 201-270 L5	56	19 S 132-S00 S3	33, 100
11 W 150-101	324	16 S 201-271 L5	56	19 S 141-40M L5	29
11 W 150-102	324	17 K 117-K01 L5	40	19 S 144-40M L5	29
11 W 150-103	324	17 K 117-K02 L5	40	19 S 145-400 L5	31
11 W 150-104	324	17 K 117-K03 L5	40	19 S 14H-40M L5	29
11 W 150-108	324	17 K 117-K04 L5	40	19 S 14K-40M L5	29
11 W 150-109	324	17 K 732-K0A S5	41, 100	19 S 14L-40M L5	29
11 W 150-115	324	17 S 101-40M L5	38	19 S 15R-001 E4	35
11 W 150-150	324	17 S 144-40M L5	38	19 S 181-5H0 E4	28
11 W 150-204	325	17 S 145-40M L5	38	19 S 201-400 L5	31
11 W 150-208	325	17 S 14A-40P L5	39	19 S 201-40M L5	30
11 W 150-209	325	17 S 14D-400 L5	39	19 S 202-40M L5	30
11 W 150-213	325	17 S 14F-40M L5	38	19 S 241-40M L5	30
11 W 150-215	325	17 S 201-40M L5	38	19 S 242-40M L5	30
11 W 150-401	325	17 S 202-40M L5	38	19 S 601-271 L5	26
11 W 150-402	325	17 S 244-40M L5	38	19 S 601-500 L5	28
11 W 150-403	325	18 K 101-270 L5	44	19 S 602-271 L5	26
11 W 150-404	325	18 K 101-K00 L5	47	19 S 641-271 L5	26
11 W 150-450	325	18 K 102-271 L5	44	19 W 002-000	35, 326
11 W 150-504	325	18 K 104-K00 L5	47	19 W 009-000	35, 326
11 W 150-506	325	18 K 107-K00 L5	47	26 S 153-S00 A1	235
11 W 150-508	325	18 K 118-K04 L5	47	28 K 101-400 L5	115
11 W 150-550	325	18 K 15R-0.5 E3	50	28 K 101-40M L5	115
11 W 152-402	325	18 K 201-271 L5	44	28 K 101-K00 N5	116
11 W 15A-502	325	18 K 201-301 L5	44	28 K 121-K20 N3	116
11 W 15A-504	325	18 K 202-270 L5	44	28 K 132-K00 N5	94, 117
11 W 15A-508	325	18 K 203-270 L5	44	28 K 132-S00 N5	94, 117
11 W 15R-401	325	18 S 101-40M L5	45	28 K 153-K00 N5	118, 231
119 K 101-272 N5	72	18 S 101-5H0 E4	45	28 K 160-S00 N5	119, 280
119 K 101-K00 N5	76	18 S 102-40M L5	45	28 K 1ER-001 N3	120
119 K 104-K00 N5	76	18 S 103-500 L5	45	28 K 201-400 N5	115
119 K 106-K00 N5	76	18 S 141-40M L5	45	28 K 201-40M L5	115
119 K 107-K00 N5	76	18 S 142-40M L5	45	28 K 203-40M L5	115
119 K 108-K00 N5	76	18 S 143-40M L5	45	28 K 401-500 N5	114
119 K 109-K00 N5	76	18 S 15R-0.5 E3	50	28 K 601-500 N5	114
119 K 111-K00 N5	76	18 S 203-40M L5	46	28 K 607-271 L5	112
119 K 112-K00 N5	76	18 S 20G-40M L5	46	28 K 607-272 L5	112
119 K 132-K00 L5	77, 93	18 S 20H-40M L5	46	28 K 607-302 N5	113
119 K 132-S00 L5	77, 93	18 S 243-40M L5	46	28 K 607-303 N5	113
119 K 153-K00 L5	77, 229	18 S 24G-40M L5	46	28 S 101-272 N	112
119 K 207-272 N5	72	18 S 24H-40M L5	46	28 S 101-K00 N5	116
119 K 207-303 N5	72	18 W 002-000	51, 326	28 S 101-S00 N5	116
119 K 732-K0B S5	77, 93	19 K 101-102 L5	27	28 S 107-102 N5	113
119 S 101-40M L5	74	19 K 101-103 L5	27	28 S 107-103 N5	113
119 S 102-400 L5	75	19 K 101-270 L5	26	28 S 107-271 N5	112
		19 K 101-271 L5	26	28 S 107-272 N5	112
		19 K 101-272 L5	26	28 S 107-302 N5	113

28 S 107-303 N5	113	32 K 486-500 L5	88	39 S 132-K00 L5	99, 139
28 S 107-307 N5	113	32 K 601-271 L5	83	39 S 132-S00 L5	99, 139
28 S 121-K20 N3	116	32 K 601-272 L5	83	39 S 501-271 L5	136
28 S 121-S20 N3	116	32 K 601-K00 L5	92	39 S 601-200 L5	138
28 S 132-K00 N5	94, 117	32 K 603-200 L5	86	45 K 101-102 L5	162
28 S 132-S00 N5	94, 117	32 K 607-302 L5	85	45 K 101-103 L5	162
28 S 147-103 N5-bl	113	32 K 607-303 L5	85	45 K 102-271 L5	162
28 S 147-103 N5-gn	113	32 K 607-303 N5	85	45 K 201-400 L5	163
28 S 147-103 N5-ro	113	32 K 644-500 L5	87	45 S 101-102 L5	162
28 S 147-103 N5-sw	113	32 K 701-200 E3	86	45 S 101-103 L5	162
28 S 153-K00 N5	118, 231	32 K 722-500 E3	88	45 S 105-101 L5	162
28 S 160-S00 N5	119, 280	32 K 724-600 S5	89	45 S 106-400 L5	163
28 S 161-102 N5	113	32 S 101-270 L5	82	45 S 201-301 L5	162
28 S 1ER-001 N5	120	32 S 102-271 L5	82	45 S 201-302 L5	162
28 S 206-271 N5	112	32 S 102-272 L5	82	45 S 201-303 L5	162
28 S 207-302 N5	113	32 S 103-S00 L5	92	45 S 201-400 L5	163
28 S 207-303 N5	113	32 S 105-K00 L5	92	51 K 101-400 A5	186
28 S 207-307 N5	113	32 S 107-302 L5	84	51 K 101-K00 N5	187
28 S 208-272 N5	112	32 S 107-302 N5	84	51 K 106-002 N5	183
28 S 247-303 N5-bl	113	32 S 107-303 L5	84	51 K 106-006 N5	183
28 S 247-303 N5-gn	113	32 S 107-303 N5	84	51 K 107-106 N5	184
28 S 247-303 N5-ro	113	32 S 107-306 L5	84	51 K 107-108 N5	184
28 S 247-303 N5-sw	113	32 S 107-307 L5	84	51 K 107-801 N5	184
28 S 263-303 N5	113	32 S 107-307 N5	84	51 K 107-802 N5	184
28 W 001-000	121, 326	32 S 121-272 S	82	51 K 107-803 N5	184
29 K 101-400 L5	65	32 S 122-271 S5	82	51 K 121-K20 S3	187
29 K 101-40M L5	64	32 S 122-272 S5	82	51 K 156-K00 N5	188, 213
29 K 102-400 L5	65	32 S 151-K00 L5	95, 191	51 K 170-C10 S3	193
29 K 10A-40M L5	64	32 S 151-S00 L5	95, 191	51 K 201-200 N5	185
29 K 153-K00 Z5	66, 234	32 S 153-K00 L5	97, 230	51 K 201-400 A5	186
29 K 153-S00 Z5	66, 234	32 S 153-S00 L5	97, 230	51 K 204-400 A5	186
29 K 201-40M L5	64	32 S 156-K00 L5	96, 212	51 K 301-K00 N5	188
29 K 203-400 L5	65	32 S 156-S00 L5	96, 212	51 K 401-K00 N5	187
29 K 203-40M L5	64	32 S 15R-0.5 E3	104	51 K 404-200 N5	185
29 K 501-500 L5	63	32 S 15R-1.0 E3	104	51 K 405-500 N5	185
29 S 111-101 L5	62	32 S 160-S00 N5	100, 281	51 K 501-K00 N5	187
29 S 111-102 L5	62	32 S 164-K00 N1	101, 263	51 K 502-200 N5	185
29 S 111-103 L5	62	32 S 17R-0.5 E3	104	51 K 504-200 N5	185
29 S 111-271 L5	62	32 S 206-271 L5	82	51 K 506-200 N5	185
29 S 132-K01 N5	66, 98	32 S 206-272 L5	82	51 K 507-200 N5	185
29 S 153-K00 Z5	66, 234	32 S 207-302 L5	84	51 K 507-801 N5	184
29 S 153-S00 Z5	66, 234	32 S 207-303 L5	84	51 K 507-802 N5	184
29 S 15R-1.0 E3	67	32 S 207-303 N5	84	51 K 507-803 N5	184
29 S 211-271 L5	62	32 S 207-306 L5	84	51 K 542-K00 A5	187
29 S 211-301 L5	62	32 S 207-306 N5	84	51 K 553-200 N5	185
29 S 211-302 L5	62	32 S 207-307 L5	84	51 K 607-106 N5	184
29 S 211-303 L5	62	32 S 207-307 N5	84	51 K 607-108 N5	184
29 Z 101-102 F	303	32 S 221-K00 L5	92	51 K 607-801 N5	184
29 Z 102-271 L	303	32 S 301-K00 L5	92	51 K 607-802 N5	184
29 Z 210-202 F	303	32 S 422-500 S5	87	51 K 607-803 N5	184
32 K 101-271 L5	83	32 S 453-K00 L5	97, 230	51 K 611-271 N5	182
32 K 101-272 L5	83	32 W 100-000	107, 328	51 K 611-272 N5	182
32 K 101-400 L5	91	32 W 100-001	107, 328	51 S 101-115 N5	183
32 K 101-K00 L5	92	32 W 100-002	107, 328	51 S 101-117 N5	183
32 K 101-KH0 L5	92	32 W 100-003	107, 328	51 S 101-272 B5	182
32 K 103-5H0 L5	87	32 W 100-004	107, 328	51 S 101-S00 N5	187
32 K 107-302 L5	85	32 W 100-005	107, 328	51 S 105-015 N5	182
32 K 107-303 L5	85	32 W 100-006	107, 328	51 S 106-001 N5	182
32 K 107-306 L5	85	32 W 100-007	107, 328	51 S 106-002 N5	182
32 K 107-307 L5	85	32 W 100-008	107, 328	51 S 106-006 N5	182
32 K 10A-40M L5	90	32 W 100-009	107, 328	51 S 107-106 N5	183
32 K 141-500 L5	87	32 W 100-010	107, 328	51 S 107-108 N5	183
32 K 145-400 L5	90	32 W 100-011	107, 328	51 S 107-801 N5	182
32 K 145-S00 L5	98, 164	32 W 100-012	107, 328	51 S 107-802 N5	182
32 K 151-K00 L5	95, 191	32 W 100-013	107, 328	51 S 107-803 N5	182
32 K 151-S00 L5	95, 191	32 W 100-014	107, 328	51 S 121-S20 S3	187
32 K 15R-001 E3	104	32 W 100-015	107, 328	51 S 131-K00 N5	189
32 K 160-S00 N5	100, 281	32 W 100-016	106, 107, 327, 328	51 S 153-K00 N5	192, 231
32 K 164-S00 N1	101, 263	32 W 100-017	107, 328	51 S 153-S00 N5	192, 231
32 K 17R-001 E3	104	32 W 100-018	107, 328	51 S 154-K00 N5	189
32 K 201-400 L5	91	32 W 100-022/01	107, 328	51 S 156-K00 N5	188, 213
32 K 241-200 L5	86	32 W 100-022/02	107, 328	51 S 156-S00 N5	188, 213
32 K 242-40M L5	90	32 W 100-022/03	107, 328	51 S 170-C10 S3	193
32 K 243-40M L5	90	32 W 100-022/04	107, 328	51 S 1RR-001 N4	193
32 K 246-400 L5	91	32 W 100-023	329	51 S 201-006 N5	183
32 K 301-K00 L5	92	32 Z 111-000 L5	105	51 S 201-K00 N5	188
32 K 401-271 L5	83	32 Z 112-000 F	105	51 S 207-302 N5	183
32 K 401-272 L5	83	32 Z 114-000 L5	105	51 S 207-303 N5	183
32 K 402-500 E3	88	32R K 132-S00 L5	98, 289	51 S 207-306 N5	183
32 K 407-302 L5	85	32R K 241-400 L5	289	51 S 207-308 N5	183
32 K 407-303 L5	85	32R K 647-302 L5	288	51 S 301-K00 N5	188
32 K 421-200 E3	86	32R S 132-K00 L5	98, 289	51 S 303-K00 N5	188
32 K 421-600 S5	89	32R S 147-302 L5	288	51 Z 101-006 A	302
32 K 421-700 S5	89	32R S 247-302 L5	288	51 Z 110-000 N	194
32 K 422-500 S5	88	39 K 102-101 L5	137	51 Z 111-000 N5	194
32 K 424-600 S5	89	39 K 102-102 L5	137	51 Z 112-000 N	194
32 K 441-500 L5	88	39 K 132-K00 L5	99, 139	51 Z 115-000 N	194
32 K 441-600 L5	89	39 K 202-301 L5	137	51 Z 120-000 B	195
32 K 449-500 L5	88	39 K 202-302 L5	137	51 Z 121-000 N	195
32 K 44N-500 L5	88	39 K 202-303 L5	137	51 Z 122-000	195
32 K 453-K00 L5	97, 230	39 K 20A-271 L5	136	51 Z 322-000	195
32 K 482-500 N5	88	39 S 101-400 L5	138	52 S 153-K00 N3	232

Index

53 K 101-115 N5	224	56 K 101-K00 N5	211	60 S 101-SIM N1	278
53 K 101-117 N5	224	56 K 107-106 N5	208	60 S 131-272 B1	276
53 K 102-K00 N5	228	56 K 107-802 N5	208	60 S 131-806 N1	276
53 K 107-106 N5	224	56 K 132-K00 L5	96, 212	60 S 131-815 N1	276
53 K 107-108 N5	224	56 K 201-200 N5	209	60 S 131-817 N1	276
53 K 132-K00 L5	97, 230	56 K 201-400 A5	210	60 S 137-273 N1	276
53 K 151-K00 N5	192, 231	56 K 404-200 N5	209	60 S 153-KIM N1	233, 280
53 K 156-K00 N5	213, 232	56 K 405-500 N5	209	60 S 15R-002 N1	282
53 K 15R-005 N3	236	56 K 407-802 N5	208	60 S 164-K00 N1	263, 279
53 K 160-KIM N1	233, 280	56 K 501-K00 N5	211	60 S 164-S00 N1	263, 279
53 K 164-S00 N1	233, 264	56 K 504-200 N5	209	60 S 165-KIM N1	269, 279
53 K 1RR-001 N3	236	56 K 508-200 N5	209	60 S 165-SIM N1	269, 279
53 K 201-200 N5	226	56 K 607-106 N5	208	60 S 17R-001 N1	282
53 K 301-K00 N5	228	56 K 607-108 N5	208	60 S 17R-C01 D3	282
53 K 401-115 N5	224	56 K 607-802 N5	208	60 S 231-K00 N1	278
53 K 401-117 N5	224	56 K 607-803 N5	208	60 S 23B-315 N1	276
53 K 401-200 N5	225	56 K 611-271 N5	206	60 S 23B-317 N1	276
53 K 401-800 N5	226	56 K 611-272 N5	206	60 W 000-002	283, 327
53 K 401-K00 N5	228	56 S 101-115 N5	207	64 K 101-K00 B1	262
53 K 403-200 N5	225	56 S 101-117 N5	207	64 K 401-200 B1	261
53 K 405-600 N5	226	56 S 101-272 B5	206	64 K 401-272 B1	260
53 K 407-106 N5	224	56 S 101-S00 N5	211	64 K 401-273 B1	260
53 K 407-108 N5	224	56 S 105-015 N5	206	64 S 101-273 N1	260
53 K 409-500 N5	227	56 S 106-006 N5	206	64 S 101-K00 B1	262
53 K 413-500 N5	227	56 S 107-106 N5	207	64 S 101-S00 N1	262
53 K 415-272 N5	222	56 S 107-108 N5	207	64 S 131-273 N1	260
53 K 465-500 N5	227	56 S 107-802 N5	207	64 S 161-273 N1	260
53 K 501-115 N5	225	56 S 107-803 N5	207	64 W 021-001	265, 327
53 K 501-117 N5	225	56 S 132-K00 L5	96, 212	64 W 021-002	271, 327
53 K 501-200 N5	226	56 S 151-K00 N5	188, 213	65 K 401-272 N1	268
53 K 502-K00 N5	228	56 S 153-K00 N5	213, 232	65 K 401-500 N1	268
53 K 503-K00 N5	228	56 S 1RR-001 N4	215	65 S 153-KIM N1	234, 269
53 K 504-272 N5	222	56 S 201-006 N5	207	65 Z 001-000 N	270
53 K 504-273 N5	222	56 S 201-015 N5	207	71 K 101-109 N5	198
53 K 505-200 N5	226	56 S 201-K00 N5	211	71 K 101-400 A5	201
53 K 505-500 N5	227	56 S 207-302 N5	207	71 K 101-K00 N5	202
53 K 507-106 N5	225	56 S 207-303 N5	207	71 K 103-400 A5	201
53 K 507-108 N5	225	56 S 209-306 N5	207	71 K 201-400 A5	201
53 K 517-271 N5	222	56 S 209-308 N5	207	71 K 501-K00 N5	202
53 K 517-802 N5	225	56 S 301-K00 N5	211	71 K 504-200 N5	200
53 K 517-803 N5	225	56 Z 112-000 N	215	71 K 507-802 N5	199
53 S 101-115 N5	223	59 K 101-001 L5	126	71 K 542-K00 A5	202
53 S 101-117 N5	223	59 K 101-002 L5	126	71 K 607-802 N5	199
53 S 101-1N9 N5	223	59 K 101-271 L5	126	71 K 611-109 N5	199
53 S 101-272 N5	222	59 K 101-K00 L5	129	71 S 102-109 N5	198
53 S 101-273 B5	222	59 K 102-400 L5	128	71 S 102-110 N5	198
53 S 101-K00 N5	228	59 K 106-101 L5	127	71 S 102-140 N5	198
53 S 101-S00 N5	228	59 K 106-102 L5	127	71 S 102-1T6 N5	198
53 S 102-015 N5	223	59 K 106-103 L5	127	71 S 102-1V6 N5	198
53 S 107-106 N5	223	59 K 132-K00 L5	99, 130	71 S 106-009 N5	198
53 S 107-108 N5	223	59 K 132-S00 L5	99, 130	71 S 107-802 N5	198
53 S 107-802 N5	223	59 K 151-K00 L5	131, 190	71 S 188-K00 L5	153, 203
53 S 107-803 N5	223	59 K 151-S00 L5	131, 190	71 S 1RR-001 N4	203
53 S 114-006 N5	223	59 K 153-K00 L5	132, 235	71 S 201-309 N5	198
53 S 132-K00 L5	97, 230	59 K 153-S00 L5	132, 235	71 S 201-K00 N5	202
53 S 151-K00 N5	192, 231	59 K 15R-001 E3	133	71 S 207-302 N5	198
53 S 152-K00 N5	232	59 K 204-301 L5	127	71 S 301-K00 N5	202
53 S 156-K00 N5	213, 232	59 K 214-271 L5	126	78 K 102-K00 L5	153
53 S 15R-005 N3	236	59 K 214-302 L5	127	78 K 104-400 L5	152
53 S 160-KIM N1	233, 280	59 K 214-303 L5	127	78 S 301-K00 L5	153
53 S 160-SIM N1	233, 280	59 S 101-400 L5	128	78 W 101-000	326
53 S 164-K00 N1	233, 264	59 S 101-S00 L5	129	88 K 171-K00 L5	153, 203
53 S 164-S00 N1	233, 264	59 S 102-102 L5	126	88 K 203-302 L5	152
53 S 165-SIM N1	234, 269	59 S 132-K00 L5	99, 130	88 K 203-3V2 L5	152
53 S 17R-001 N3	236	59 S 132-S00 L5	99, 130	88 K 505-1V2 L5	152
53 S 1RR-001 N3	236	59 S 151-K00 L5	131, 190	88 S 105-1V2 L5	152
53 S 201-K00 N5	228	59 S 151-S00 L5	131, 190	88 S 171-K00 L5	153, 203
53 S 205-272 N5	222	59 S 153-K00 L5	132, 235	88 S 171-S00 L5	153, 203
53 S 205-306 N5	224	59 S 153-S00 L5	132, 235	88 S 203-3V2 L5	152
53 S 205-308 N5	224	59 S 15R-001 E3	133		
53 S 205-315 N5	224	59 S 206-400 L5	128	L	
53 S 205-317 N5	224	59 S 212-400 L5	128	L E3-006-100	298
53 S 301-K00 N5	228	59 S 225-400 L5	128	L H1-021-300	298
53 S 401-200 N5	225	59 S 301-K00 L5	129	L H1-053-xxx-NM	299
53 W 008-000	237, 327	59 S 301-S00 L5	129	L H1-071-300	298
53 Z 111-000 N5	237	59 S 601-200 L5	127	L H1-099-300	298
53 Z 113-001 N	237	59 S 601-S00 L5	129		
53 Z 115-004 N	237	59 S 602-200 L5	127		
53 Z 117-000 N	237	60 K 101-KIM N1	278		
53Q K 105-K00 S3	255	60 K 131-815 N1	277		
53Q K 105-S00 S3	255	60 K 131-817 N1	277		
53Q K 105-S20 S3	255	60 K 15R-002 N1	282		
53Q K 153-S00 N5	229, 254	60 K 164-S00 N1	263, 279		
53Q K 40A-500 N5	253	60 K 164-S60 N1	263, 279		
53Q K 44F-500 N5	253	60 K 17R-001 N1	282		
53Q K 501-272 N5	252	60 K 17R-C01 D3	282		
53Q S 101-272 B5	252	60 K 431-815 N1	277		
53Q S 105-K00 S3	255	60 K 431-817 N1	277		
53Q S 105-K20 S3	255	60 K 442-272 N1	276		
53Q S 105-S00 S3	255	60 K 47U-900 N1	277		
53Q S 153-K00 N5	229, 254	60 K 501-K50 N1	278		
54 S 151-K00 A1	189	60 S 101-KIM N1	278		

Headquarters

Rosenberger

Hochfrequenztechnik GmbH & Co. KG

Hauptstraße 1 | 83413 Fridolfing

P.O. Box 1260 | 84526 Tittmoning

Germany

Phone **+49 (0)8684 18-0** info@rosenberger.de

Fax +49 (0)8684 18-1499 www.rosenberger.com

The logo for 4TECT features a large, stylized orange number '4' followed by the word 'TECT' in a bold, grey, sans-serif font. The '4' has a slight 3D effect with a shadow.

ООО «4TECT»

Телефон: +7 (499) 685-4444

info@4test.ru

www.4test.ru



ООО «4TECT»

Телефон: +7 (499) 685-4444

info@4test.ru

www.4test.ru

Rosenberger

Hochfrequenztechnik GmbH & Co. KG

Hauptstraße 1 | 83413 Fridolfing

P.O. Box 1260 | 84526 Tittmoning

Germany

Phone +49 (0)8684 18-0

Fax +49 (0)8684 18-1499

info@rosenberger.de

www.rosenberger.com

Certified by ISO/TS 16949 · ISO 9001 · ISO 14001

Order No.

Info 100ComCat | pA 155385

11/2014

Rosenberger® is a registered trademark by Rosenberger Hochfrequenztechnik GmbH & Co. KG.
All rights reserved.

© 2014 Rosenberger

